



HARRIS

Broadcast Equipment
Catalog AP-2

FOREWORD

Harris Corporation, Broadcast Division, presents Catalog AP-2. Our latest all-products catalog features television and radio transmitting equipment, audio and video studio products, program and business automation systems, and broadcast microwave equipment. The comprehensive product line represented on these pages meets virtually every requirement of the television and radio broadcaster.

The Harris sales network and service facilities are extensive. Canadian sales are handled by Harris Systems Limited in Montreal. International market activities are coordinated by the International Sales Department in Quincy, Illinois with representatives located throughout the world.

The Broadcast Division is one of 26 divisions of Harris Corporation. Among the nation's 500 largest corporations, Harris is a world leader in the communications industry, with a broad product base ranging from printing presses to computer systems. Two separate operating arms of the Broadcast Division produce specialized products for the broadcaster. Harris Video Systems, located in Sunnyvale, California, manufactures an extensive line of digital video products. Harris Broadcast Microwave Operation, San Carlos, California, manufactures ENG receivers, miniature portable microwave receivers and transmitters.

Drawing on the considerable resources of research centers within the Harris electronic group, the Broadcast Division has ready access to a large staff of professional scientists and engineers, in addition to maintaining an impressive engineering and service organization in Quincy.

Harris' reputation stands on the products in this catalog. Harris values your patronage, and will strive for continued excellence in product design and execution, in an innovative posture that fosters the advancement of the broadcast industry.



HARRIS



HARRIS

PDM

Pulse Duration Modulation

Harris' patented Pulse Duration Modulation (PDM) is used in the Harris VP-100A, SW-100, SW-50, MW-50A, MW-10, and MW-5A broadcast transmitters. PDM produces conventional high level plate modulation....the difference is simply the manner in which the audio signal is amplified and applied in series with the RF amplifier plate supply. However, this one difference provides several distinct advantages....particularly a much higher efficiency, and the elimination of large iron core components.

The Pulse Duration Modulator operates as follows:

1. The audio input (A) is added to a 75 kHz sawtooth wave (B) to form (C).
2. A threshold level (power control) is set and determines the point on the sawtooth wave at which the pulse amplifier will conduct. After clipping and amplification, squared pulses (D), which vary in duration with the input audio, are formed.
3. A low pass filter removes the 75 kHz pulse rate, leaving very high audio power to fully modulate the PA. No modulation transformer or reactor is required.

The duty cycle of the pulse determines the voltage at the plate of the PA. For instance, a 50% duty cycle will produce 13 kV at the PA or the 100 kW carrier; a 100% duty cycle will place the full supply voltage of about 28 kV on the PA which conforms to over 100% positive modulation peak; a 0% duty cycle will produce 0 voltage at the PA or the 100% negative modulation tip. The rate of variation of the pulse width is the audio signal...hence a Pulse Duration Modulator.

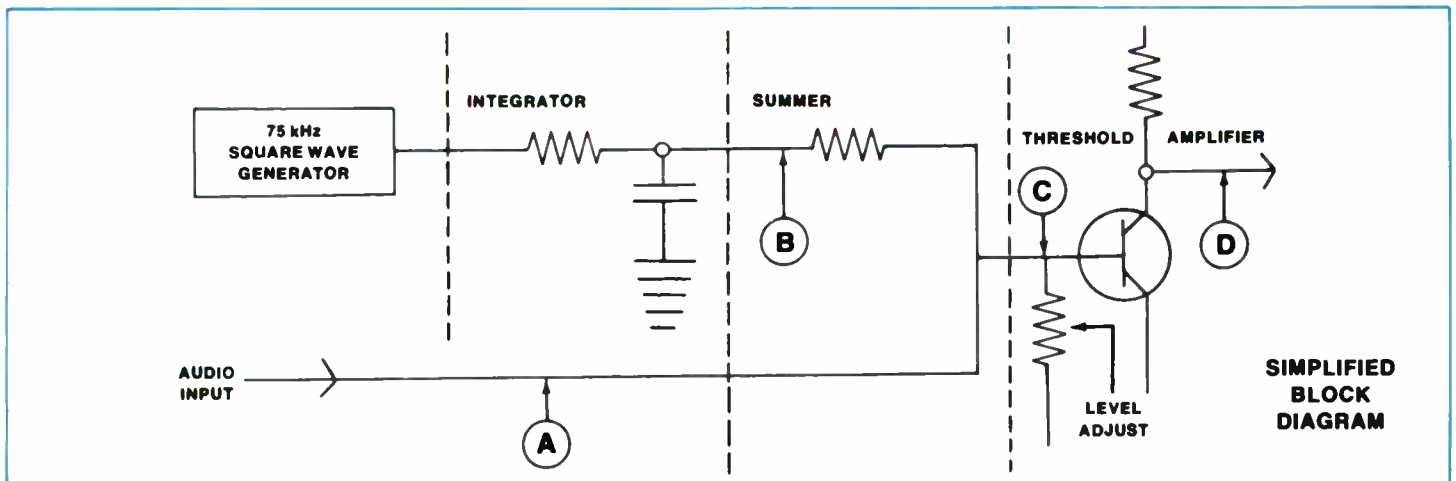
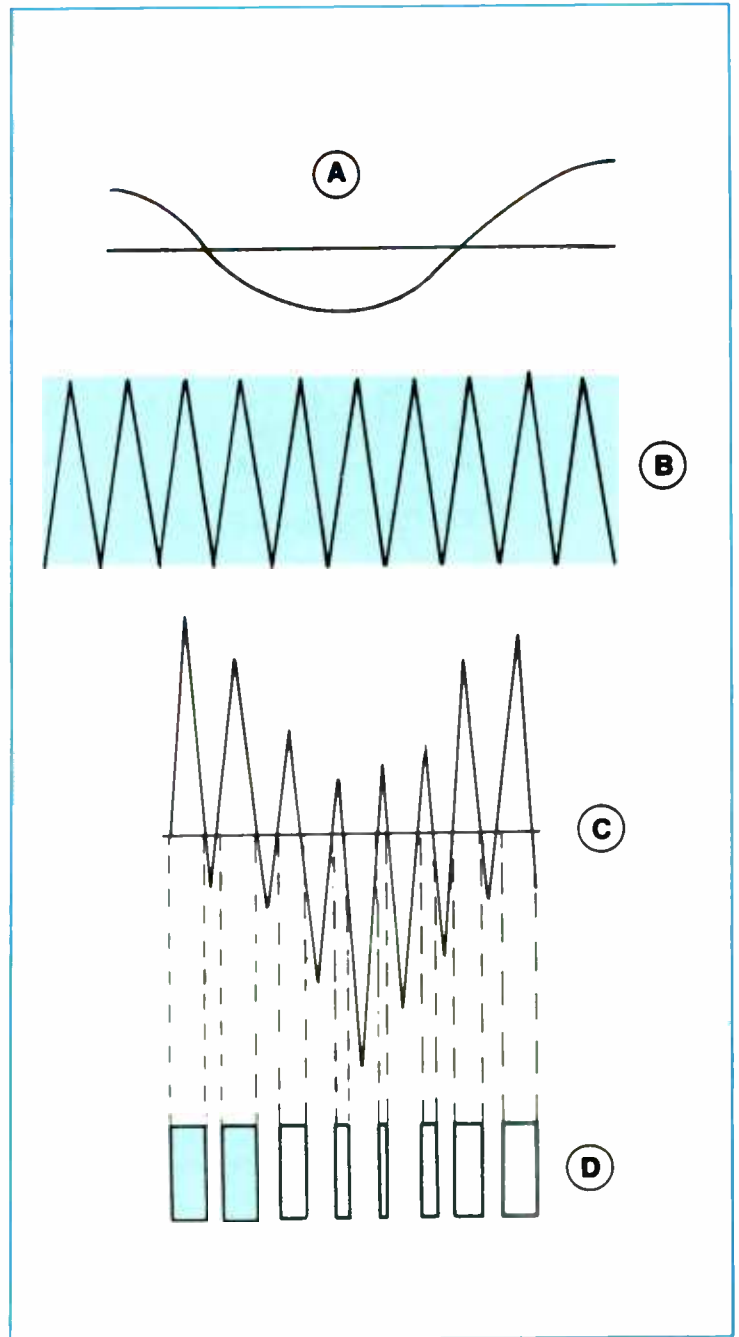



HARRIS

PSM

Progressive Series Modulator

Up to now, series modulators—which have the advantage of great operational simplicity—have been too inefficient to be used effectively. Now, with the introduction of Harris' Progressive Series Modulator, simplicity and high efficiency have been combined into one excellent high-level modulation method which is used in Harris' solid-state 1 kilowatt AM transmitter, the MW-1A.

A conventional series modulator is shown in Figure A. It has one active device, Q1 (modulator), which regulates the 100 volt power supply to provide the proper voltage at carrier and the modulation voltage to the PA. Its only drawback is its inefficiency. Under carrier conditions, only 50 volts is required at the PA. This means 50 volts is also across the modulator, Q1. Whatever current is required at the PA must flow through Q1.

Assume 24 amps and 50 volts is required at the PA to achieve the 1000-watt carrier. This means 24 amps is also flowing in Q1 and the power lost in Q1 is 1200 watts (all heat). This is much too inefficient, even for a one kilowatt transmitter. The PA and output network operate at about 85%, so the loss in the PA and output network is only 200 watts. (1200 watts input and 1000 watts rf output = 85% efficiency.)

If the advantages of a DC coupled series modulator are to be utilized, a more efficient method must be found—hence a Progressive Series Modulator (PSM). PSM is two series modulators, in series, as shown in Figure B. Two power supply voltages are now used. One is a little higher than that required to produce the proper PA voltage at carrier conditions, and the second is high enough to provide the positive peak required.

Now, during carrier, all the PA voltage comes from the 52-volt supply through CR1 and Q1. Only about 2 volts is lost across the modulator, so the required 50 volts, 24 amps is provided the PA. The loss across the modulator at carrier is now 2×24 , or 48 watts, and the power to the PA is 50×24 , or 1200 watts.

During the positive peak the PA voltage is supplied from the 104-volt supply through Q2 and Q1 (CR1 disconnects the 52-volt supply when Q2 turns on.) During the negative peak Q2 is open, and the voltage is supplied from the 52-volt supply through CR1 and Q1

Thus PSM—a Progressive Series Modulator which is highly efficient, is DC coupled, has excellent transient response, and requires no modulation transformer or reactor or filter inductor.

NOTE: Voltages used in the MW-1A vary slightly from the example above, to provide 125% positive peak modulation capability.

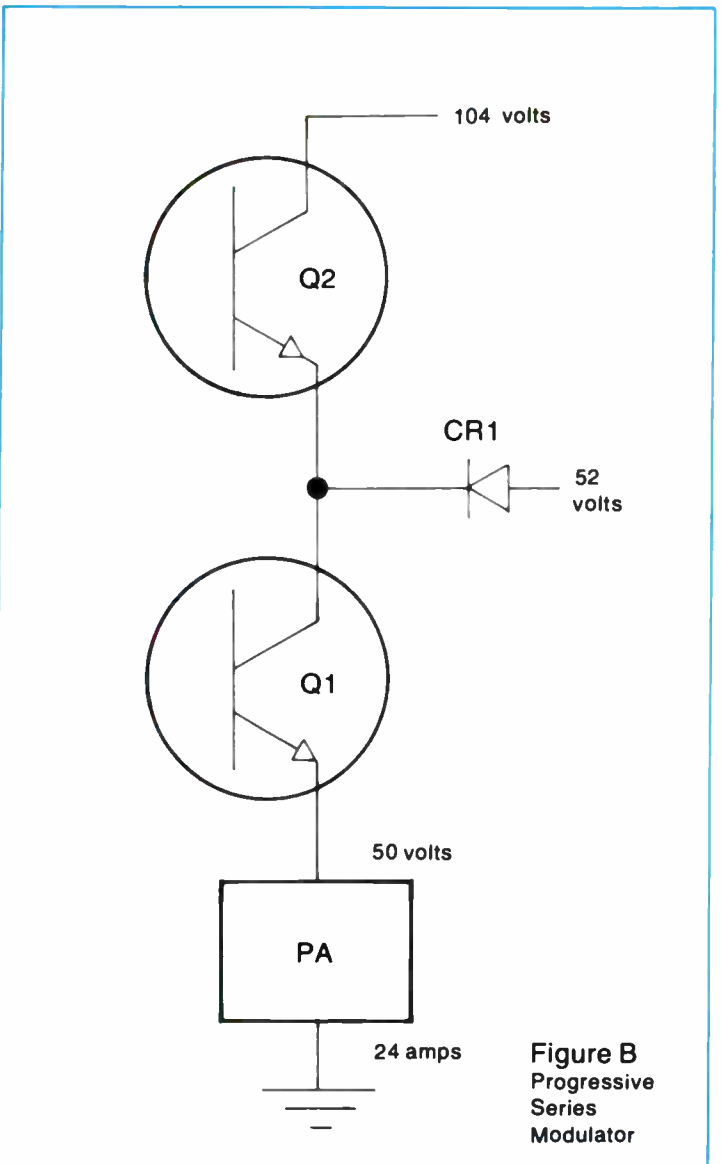
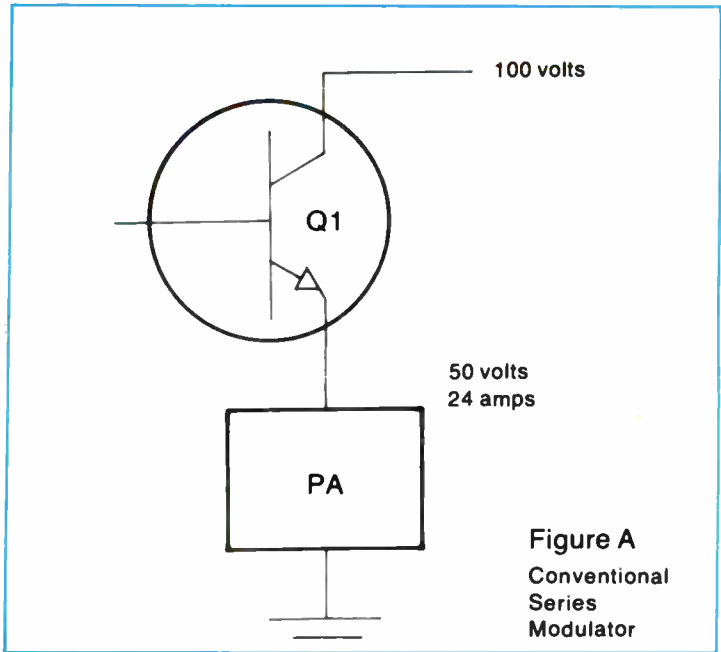



HARRIS

VP-100A

**100,000 Watt
Medium Wave
Broadcast
Transmitter**

- Overall efficiency better than 65%
- Exclusive Pulse Duration Modulator [PDM]* for high level plate modulation
- Redundancy in solid state circuits
- Vapor phase cooling for quiet operation and extended tube life
- Only five tubes, with three tube types
- Designed for a wide climate range

*Patented

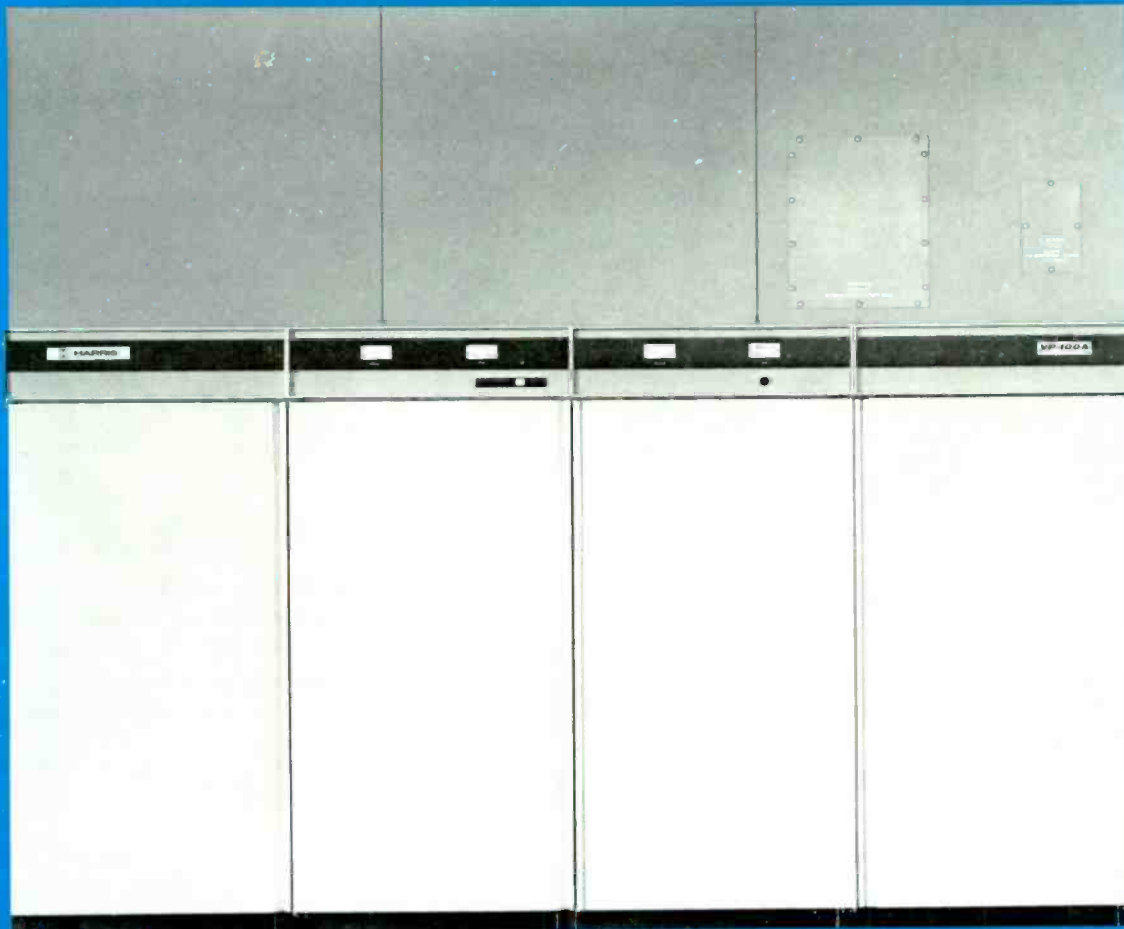



Front view, doors open

Featuring Harris' exclusive high level Pulse Duration Modulator*, the VP-100A provides the finest performance of any medium wave broadcast transmitter in the same power range on the market today ...at significantly lower operating costs.

EFFICIENCY EXCEEDS 65%. The VP-100A has an unusually high overall efficiency of more than 65%. This is made possible by the almost 90% efficiency of the Pulse Duration Modulator—and means about one-third less power consumption than other high level plate modulated 100 kilowatt transmitters.

HIGH AVERAGE MODULATION CAPABILITY. The transmitter is capable of sustained high average modulation such as that experienced with trapezoidal audio processing—which means greater loudness at the receiver without increased transmitter carrier power. This is a feature of the high efficiency, DC coupled PDM modulator that avoids the use of large, inefficient transformers in the modulation process. Another feature of this high efficiency series type modulator is convenient front panel carrier power adjustment over a wide range.

ONLY FIVE TUBES. The entire transmitter employs just five tubes—with a modern ceramic 4CV100,000C power tetrode in the modulator and final RF power amplifier sockets. All power supplies utilize long-life solid state silicon rectifiers. High quality components, conservatively rated, are used throughout the VP-100A to assure greatest reliability.

VAPOR PHASE COOLING. Cooling by the Vapor Phase method

*U.S. Patent No. 3440566

produces quiet operation by eliminating the need for large blowers—the heat exchanger is cooled by a two horsepower blower. This method of cooling also extends tube life by helping to eliminate "hot spots" and by maintaining tube anode temperatures far below those attained by other methods.

RF SECTION. The RF chain is conventional, using a transistorized oscillator, buffer, emitter follower, and a 4CX1500A tetrode tube amplifier to drive a single 4CV100,000C tetrode Class C power output stage.

An automatic drive control limits the PA screen current, eliminating the usual problem of over dissipating the screen of a tetrode during tune-up.

THE MODULATION SYSTEM. Harris' exclusive Pulse Duration Modulator is characterized by low plate dissipation and low peak currents; peak cathode currents are about one-half that of the other 100 kilowatt transmitters. Average plate dissipation runs substantially below rated levels, and all peak voltages are maintained well below component ratings.

Wide frequency response is possible as large reactive components are not used in the modulation system.

Control of the transmitter power output over a wide range is accomplished in a low-level stage of the modulator by means of a convenient front panel vernier control. No adjustment is necessary in any high power RF circuit, including the loading coil.

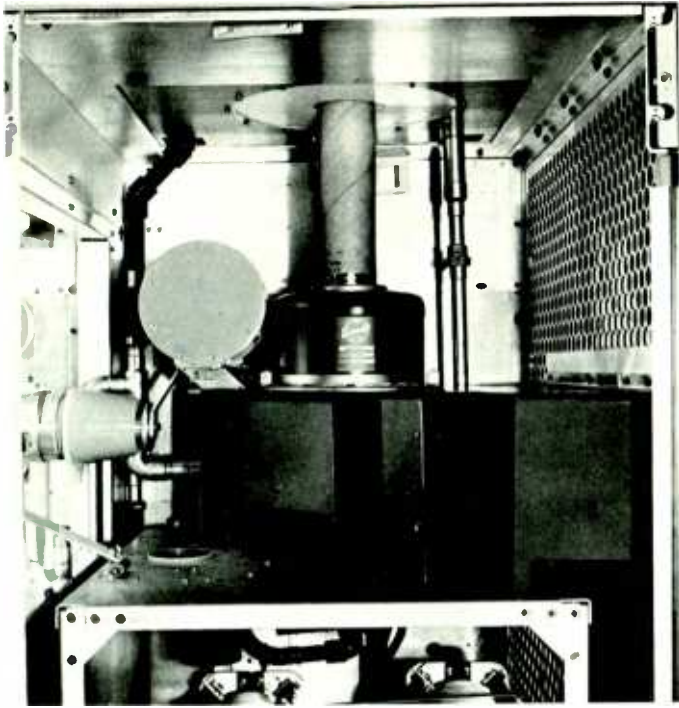

Power amplifier tube compartment, rear view.

PROTECTIVE CIRCUITS. All major components of the VP-100A are protected by circuit breakers. Tubes and transistors are protected by overload relays or current-limiting devices.

A quick-acting circuit protects against damage by high voltage arcs by limiting the energy in such arcs to less than 10 watt seconds.

Protection against voltage standing wave ratios of greater than 1.2:1 is provided. Both forward and reflected power are metered at the front panel.

In case of momentary RF overloads the VP-100A will recycle twice automatically. Should a third overload occur within a thirty second period, the transmitter will remain off until manually reset. However, if the time between overloads is greater than thirty seconds, continuous recycling will occur.

DUAL OSCILLATOR AND MODULATOR. Harris has provided redundancy in all transistor sections to relieve any concern over solid state circuitry in high-powered transmitters. Although the reliability of transistor circuitry has been proven in transmitters now operating under extreme conditions, this duplication is your double assurance of complete dependability.

DESIGNED FOR WIDE RANGE OF CLIMATES. The transmitter will give top performance in a wide range of climates—from hot and humid, to dry and dusty. With Vapor Phase cooling, ducting outside air into the transmitter is not necessary. All transformers and similar components are hermetically sealed, encased, or vacuum impregnated. All high power radio frequency networks contain silver-plated inductors and vacuum capacitors.

GREATLY REDUCED FLOOR SPACE. Due to the high efficiency of the transmitter and the elimination of large iron core components (no modulation transformer and reactor), the VP-100A requires only 7.0 square meters (76 square feet) of floor space. Careful cabinet design provides easy accessibility to all components.

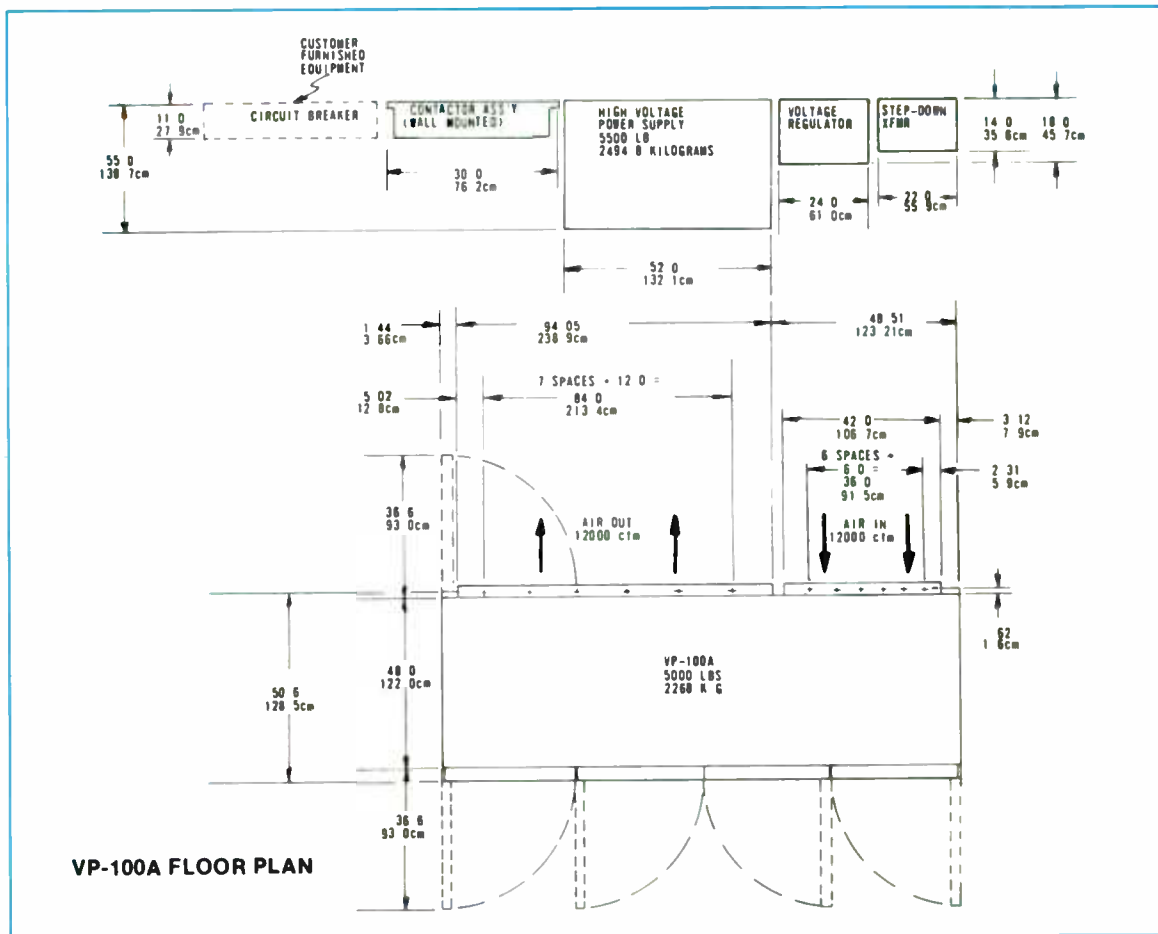

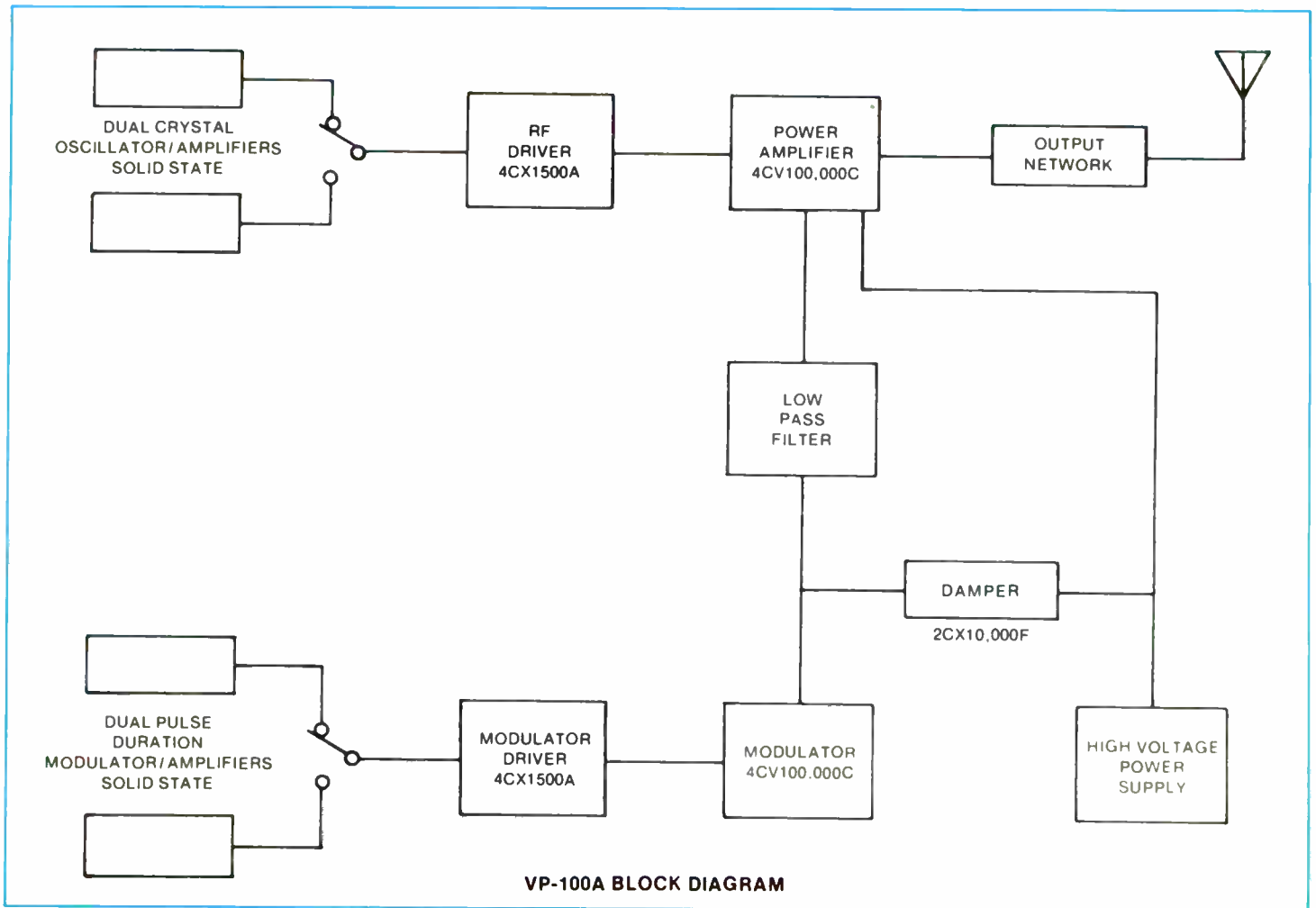

VP-100A SPECIFICATIONS

POWER OUTPUT: 100,000 watts nominal unmodulated, capable 110,000 watts.
RF FREQUENCY RANGE: 535 kHz to 1620 kHz.
RF OUTPUT IMPEDANCE: 230 ohms, unbalanced.
RF FREQUENCY STABILITY: ± 5 Hz.
SPURIOUS AND HARMONIC EMISSION: Less than 50 mW.
CARRIER SHIFT: Less than 5% at 100% modulation at 1,000 Hz.
AUDIO FREQUENCY RESPONSE: ± 1.5 dB from 40 to 10,000 Hz referenced to 1,000 Hz at 95% modulation.
AUDIO FREQUENCY DISTORTION: Less than 3% from 40 to 10,000 Hz at 95% modulation.
NOISE: 55 dB below 100% modulation at 1,000 Hz.
AUDIO INPUT LEVEL: 10 dBm ± 2 dB for 100% modulation.
AUDIO INPUT IMPEDANCE: 600/150 ohms, balanced or unbalanced.
MODULATION LEVEL: 100% sinusoidal, 10 minutes, 50 to 5,000 Hz.
TRAPEZOIDAL MODULATION: Less than 5% tilt or overshoot, 100 Hz to 2,000 Hz.

POWER INPUT: Any specified voltage 380V to 480V, 3 phase, 50 or 60 Hz.
POWER CONSUMPTION: 155 kW—No modulation
 160 kW—30% modulation
 215 kW—100% modulation
POWER FACTOR: 95%.
VOLTAGE REGULATOR: Electronic voltage regulation for all power supplies other than high voltage.
OVERALL EFFICIENCY: 65% at average modulation.
TUBES: Two 4CV100,000C; two 4CX1500A; one 2CX10,000F.
TEMPERATURE RANGE: 0-50°C ambient air temperature.
HUMIDITY: 95% relative humidity, maximum.
STORAGE TEMPERATURE: 35°C to 60°C (with no water in system).
ALTITUDE: Up to 1,829 meters (6,000 feet) above sea level.
CABINET DATA: Each of two cabinets measures 1.83 meters (6 feet) wide, 1.37 meters (4.5 feet) deep, and 1.98 meters (6.5 feet) high. The heat exchanger adds another 1.06 meters (3.5 feet) in height.

ORDERING INFORMATION

VP-100A, 100,000 watt medium wave transmitter with one set of tubes, crystals and silicon rectifiers, for operation from 380 to 480 volts, 3 phase, 50 or 60 Hz 994-7651-001



HARRIS

MW-50B

50,000 Watt
Medium Wave
Broadcast
Transmitter

- Pulse Duration Modulation* (PDM) eliminates costly, inefficient modulation transformer and reactor
- Unsurpassed low frequency square wave performance
- Automatic modulation tracking minimizes adjustments
- 50% reduction in overshoot
- No Slew Induced Distortion possible
- Greater than 60% overall efficiency
- Only two tube types
- Produces faithful transmission of today's demanding formats in a cost effective manner

* Patented

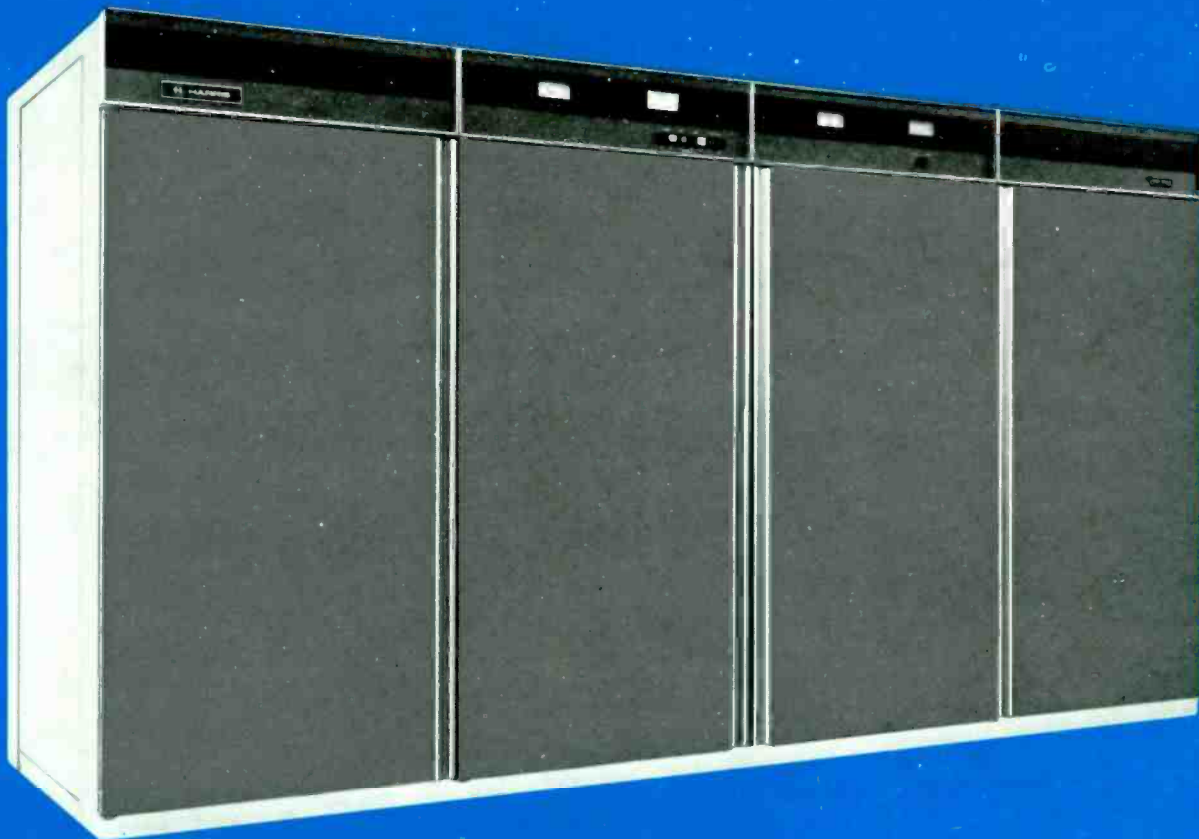

Harris' MW-50B . . . the world standard in 50kW AM transmitters

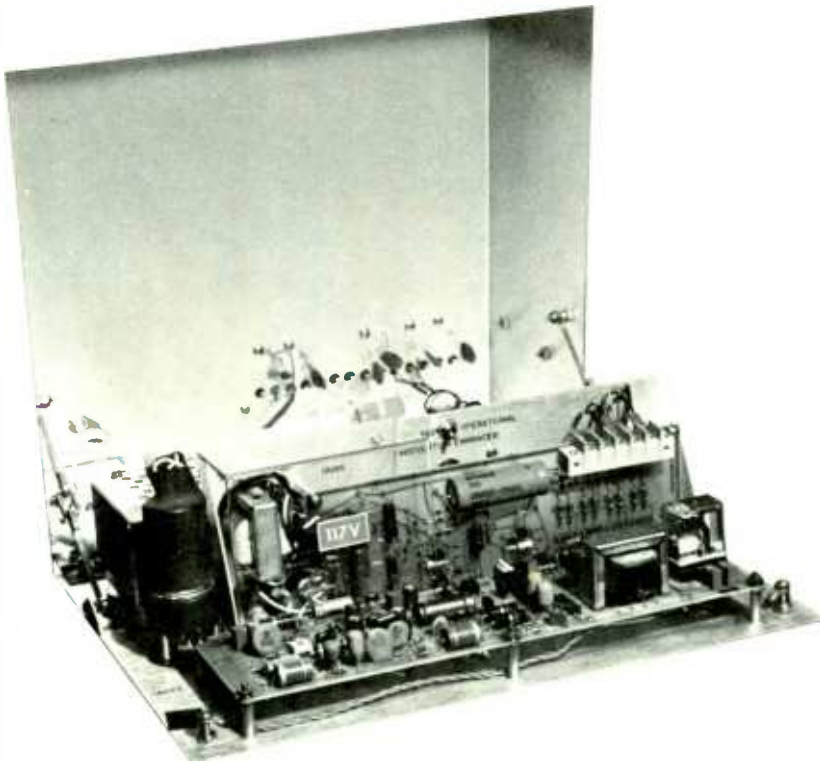

Low level Pulse Duration Modulator chassis, showing power control and audio input/control.

The Harris MW-50B delivers overall performance superior to any other 50-kilowatt medium wave broadcast transmitter. The transmitter is high level plate modulated, using Harris' patented, highly efficient Pulse Duration Modulator (PDM). This, in combination with a number of other outstanding features, makes the MW-50B the most advanced 50-kilowatt AM transmitter in the world.

THE MODULATION SYSTEM

Harris' Pulse Duration Modulator is characterized by low plate dissipation and low tube peak currents. Peak cathode currents are about one-half that of comparable transmitters. Average plate dissipation runs substantially below rated levels, and all peak voltages are maintained well below component ratings. Conservative design allows a continuous 100% sine wave modulation rating. Additionally, the PDM design allows continuous 100% sine wave modulation.

IMPROVED SQUARE WAVE PERFORMANCE

With the addition of a new op-amp audio input stage, the MW-50B is now effectively DC coupled from the audio input to the RF power amplifier. This new circuit extends the transmitter's low end frequency response essentially to DC, approximately 2 Hz.

Consequently, the MW-50B enjoys a noticeable improvement in square wave performance, with low frequency tilt nearly non-existent. The MW-50B's low frequency response

can be tailored to meet individual stations' programming needs.

IMPROVED OVERTHOOT PERFORMANCE

Harris has incorporated circuitry that effectively reduces complex audio overshoots by 30%, without compromising any other audio specification. This improvement allows MW-50B users to increase their average modulation over the already high level characteristic of Harris' Pulse Duration Modulation. By

selection of a single component the frequency response of the MW-50B may be tailored to best suit the station format.

IMPROVED TRANSIENT RESPONSE

Installation of a high speed op-amp input stage has the same advantages as an audio input transformer—good isolation, impedance matching and common mode rejection. At the same time, the balanced op-amp input stage allows a dramatic improvement in transient response. The result: even more faithful transmission of today's dynamic program material.

HIGH OVERALL EFFICIENCY

The Pulse Duration Modulator employed in the MW-50B approaches 90% efficiency. This impressive modulator efficiency enables the transmitter to achieve an unusually high *overall* efficiency of greater than 60%. As a result, power consumption is significantly below that of other 50-kilowatt medium wave transmitters currently available, or in service.

AUTOMATIC MODULATION TRACKING

Since incoming AC line voltages change radically during the course of the broadcast day, there is a direct effect on transmitter DC supply voltage, and hence power output. If the carrier is over or under modulated, output power changes may hinder the transmitter's audio performance. The new MW-50B **Modulation Tracking Circuit** eliminates these problems by automatically maintaining the desired modulation level over a $\pm 20\%$ change in output power. This precision tracking circuit eliminates the need to purchase costly, single-function units requiring system interface.

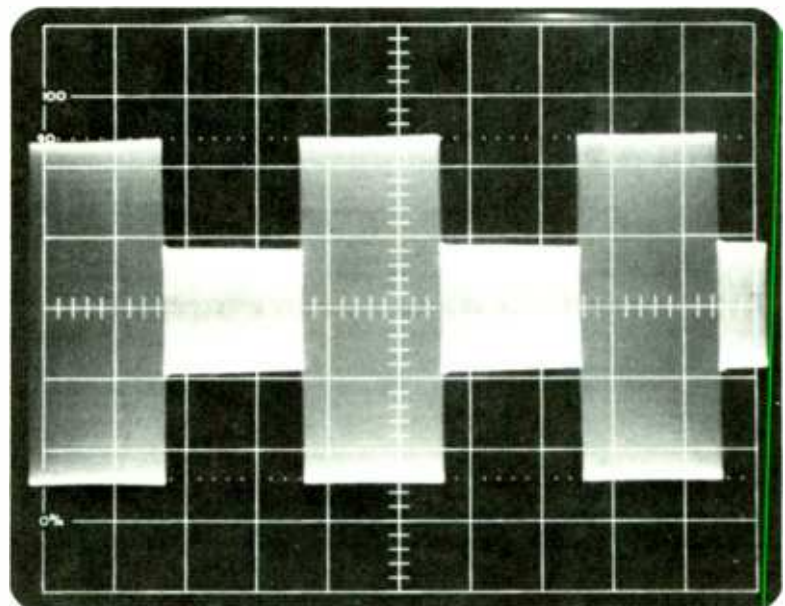

Wave form monitor showing square wave response of MW-50B.

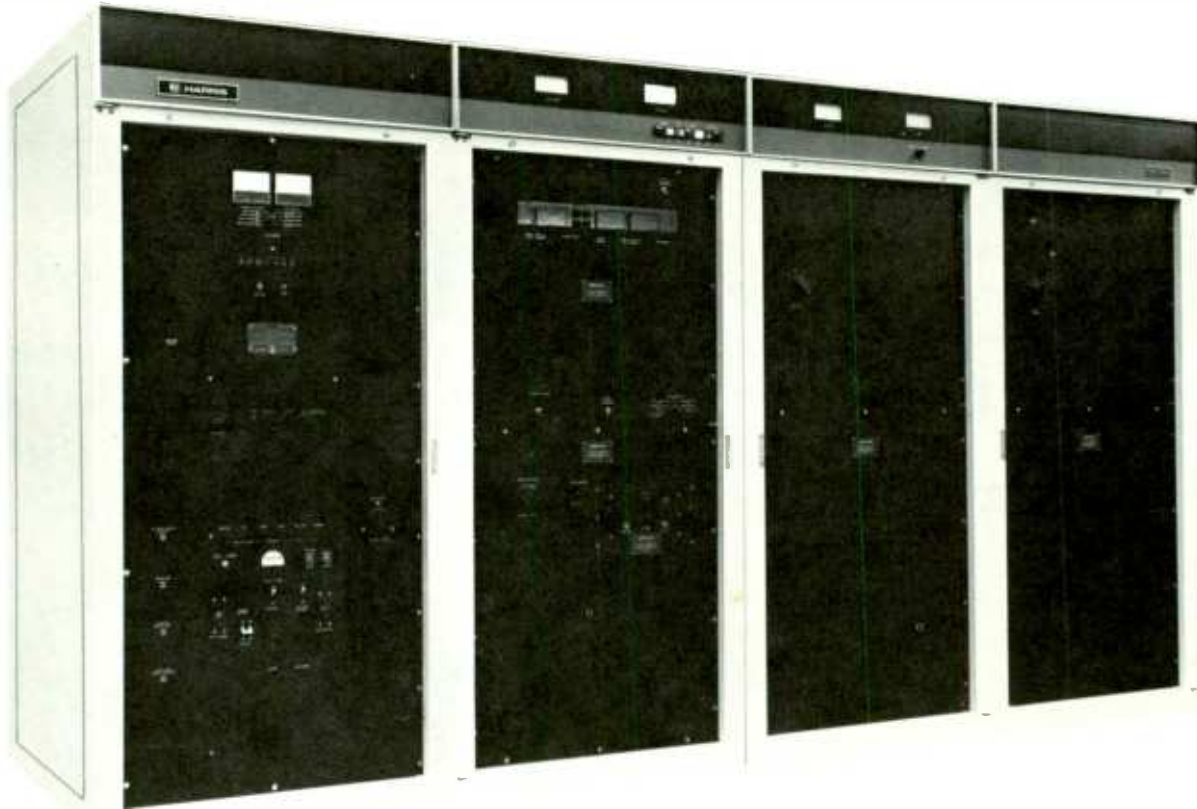

MW-50B, front doors removed.

ONLY FOUR TUBES . . . EXCEPTIONAL TUBE LIFE

The MW-50B employs just four tubes. Rugged ceramic 4CX35,000C tetrode power tubes are used in the power amplifier and modulator. The Pulse Duration Modulator driver and R. F. driver each use a 4CX1500A. Use of just two tube types greatly simplifies spares stocking and associated spares costs. Highest quality components, conservatively rated, are used throughout the MW-50B to assure a maximum degree of reliability. Satisfied MW-50 owners report 3-5 year PA and modulator tube life, considerably lowering operating costs.

CONTINUOUS 100% MODULATION RATING

This continuous sine wave modulation capability permits a higher average modulation to boost signal strength without increasing transmitted carrier power. The MW-50B provides 125% positive peak capability.

MAXIMUM CARRIER POWER 60 KILOWATTS

The Harris MW-50B provides a maximum carrier power of 60 kilowatts, allowing more reserve for driving directional arrays than any other 50-kilowatt medium wave broadcast transmitter. DC and audio feedback insures overall transmitter stability. The MW-50B can be switched smoothly from high to low power

(any power from 50 kw to 10 kw) without loss of carrier, thus minimizing annoying off-air power changes.

RF SECTION

The RF chain is conventional, utilizing a transistorized oscillator, buffer, emitter follower, and a 4CX1500A tetrode tube amplifier to drive a single high efficiency 4CX35,000 tetrode in a Class D power output stage.

PROTECTIVE CIRCUITS, STATUS CHANNELS

All major components of the MW-50B are protected by circuit breakers. Tubes and transistors are protected by overload relays or current limiting devices. Overloads are indicated on a LED fault status panel. A quick-acting circuit protects against damage from high voltage arcs by limiting the energy in such arcs to 10 watt seconds. Protection against voltage standing wave ratios of greater than 1.2 to 1.0 is provided. Both forward and reflected power are metered at the front panel.

In case of momentary RF overloads, the MW-50B will recycle automatically. Should a repeated overload occur within a 30-second period, the transmitter will remain off until manually reset. However, if the time between overloads is greater than 30 seconds, continuous recycling will occur.

QUIET AIR COOLING

Cooling of the MW-50B is accomplished by a 3-horsepower blower, located in the transmitter cabinet, which provides cooling for the power tubes at a low noise level. The transmitter cabinet air is flushed with a low speed fan which also operates at a low noise level. Provisions are made at the top of the transmitter for ducting the exhaust air to the outside of the transmitter building. The transmitter can also be configured to allow the blower to be externally located.

DESIGNED FOR A WIDE RANGE OF CLIMATES

The MW-50B provides top performance in all types of climates, from hot and humid to dry and dusty. All transformers and similar components are hermetically sealed, encased, or vacuum impregnated. Performance at 10,000 feet (3048 meters) is certified by a recognized testing organization.*

TRANSMITTER LAYOUT

The MW-50B consists of two cabinets and an external high voltage power supply. External connections to the transmitter are made through either the top or the bottom of the unit, as desired, for great installation flexibility.

* Copy of certificate available on request.

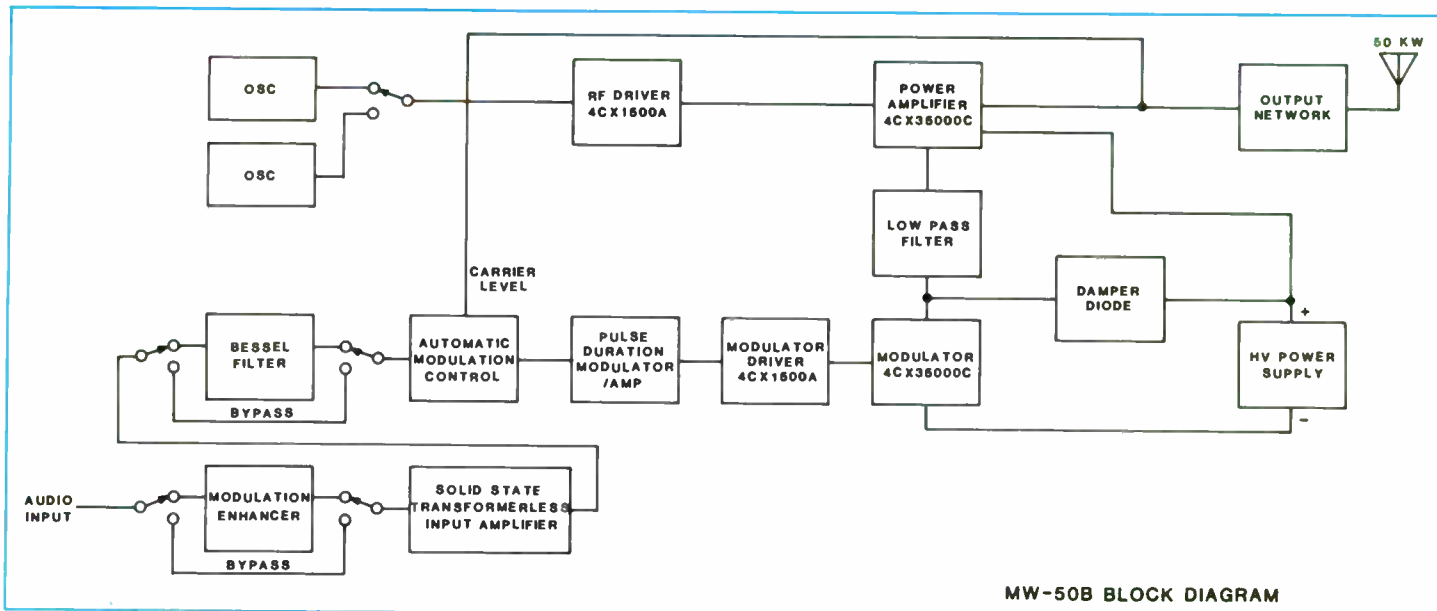

MW-50B SPECIFICATIONS

POWER OUTPUT: 50,000 watts (rated), 60,000 watts (capable). Convenient power reduction to 25,000 or 10,000 watts.

RF FREQUENCY RANGE: 535 kHz to 1620 kHz, supplied to frequency as ordered.

RF OUTPUT IMPEDANCE: 50 ohms unbalanced (higher on special order).

RF FREQUENCY STABILITY: ± 5 Hz.

RF HARMONICS: Exceeds FCC and CCIR specifications.

CARRIER AMPLITUDE REGULATION: Less than 2% at 100% modulation (measured at 1000 Hz).

AUDIO FREQUENCY RESPONSE: ± 1.5 dB, from 20 to 12,500 Hz, referenced to 1,000 Hz at 95% modulation.

TOTAL HARMONIC DISTORTION (Unenhanced): Less than 3%, 20 to 10,000 Hz at 95% modulation.¹

COMPRESSION RATIO: 4/1 dB at 3 dB of enhancement; - 95% + 125% modulation.

NOISE (Unweighted): -60 dB or better below 100% modulation. Typical -62 dB.²

AUDIO INPUT: 600 ohms at 0 to +10 dBm for 100% modulation, unenhanced; +16 dBm with enhancement activated.

POWER INPUT: 480 V $\pm 5\%$, 3 phase, 60 Hz. Available for 380 V $\pm 5\%$, 3 phase, 50 Hz.

POWER CONSUMPTION: 80 kW at 0% modulation; 87 kW at 30% modulation; 110 kW at 100% modulation.³

OVERALL EFFICIENCY: Better than 60% at average modulation.

POWER FACTOR: 95%

TUBES USED: (2) 4CX35,000C; (2) 4CX1500A.

TEMPERATURE RANGE: -20°C to +50°C.⁴

HUMIDITY: 95%

ALTITUDE: Up to 3,048 meters (10,000 feet) above sea level. Higher on special order.

SIZE: 78 inches (2.0 meters) high, 144 inches (3.7 meters) wide, 48 inches (1.2 meters) deep (transmitter cabinet). External components include high voltage power supply and wall mounted circuit breaker assembly.⁵

FLOOR SPACE: Main transmitter assembly 48 square feet (4.5 square meters). Power supply 15 square feet (1.4 square meters).

WEIGHT (Approximate):

Main Transmitter Assembly

Net unpacked 5,000 lbs. (2268 kg)

Domestic packed 6,000 lbs. (2722 kg)

Export packed 7,200 lbs. (3266 kg)

Power Supply

Net unpacked 1,370 lbs. (622 kg)

Domestic packed 1,500 lbs. (681 kg)

Export packed 1,800 lbs. (817 kg)

1. Distortion measured at 95% modulation, or less, down to 25%. If transmitter is operated into a bandwidth limited antenna system, distortion at the higher modulation frequencies may degrade.
2. Noise measured over the band 20 Hz to 20 kHz, with line to line voltages of the supply line balanced. Noise may degrade with line voltage unbalance.
3. Typical power consumption figures are for 50 kilowatts output and for optimum transmitter adjustment. For higher output powers and/or transmitter misadjustments, power consumption may be higher.
4. Maximum operating temperature derates linearly to +29°C (84.2°F) at 10,000 feet AMSL (3048 meters).
5. Does not include height of output connector, which may be removed for transport.

specifications subject to change without notice

ORDERING INFORMATION

MW-50B, basic transmitter	994-8617-003
Model MW-50B, with one set of tubes and 2 crystals, 60 Hz	994-8617-001
Model MW-50B, with one set of tubes and 2 crystals, 50 Hz	994-8617-002
Recommended spare parts kit for MW-50B transmitter	994-8618-001



HARRIS

MW-10B

10,000 Watt
Medium Wave
Broadcast
Transmitter

- Pulse Duration Modulation* (PDM) eliminates costly, inefficient modulation transformer and reactor
- Unsurpassed low frequency square wave performance
- Automatic modulation tracking minimizes adjustments
- No significant overshoot...yielding maximum modulation capability
- No Slew Induced Distortion possible
- High modulator and PA efficiency yields low power consumption
- Only two tube types
- Produces faithful transmission of today's demanding formats in a cost effective manner

*Patented

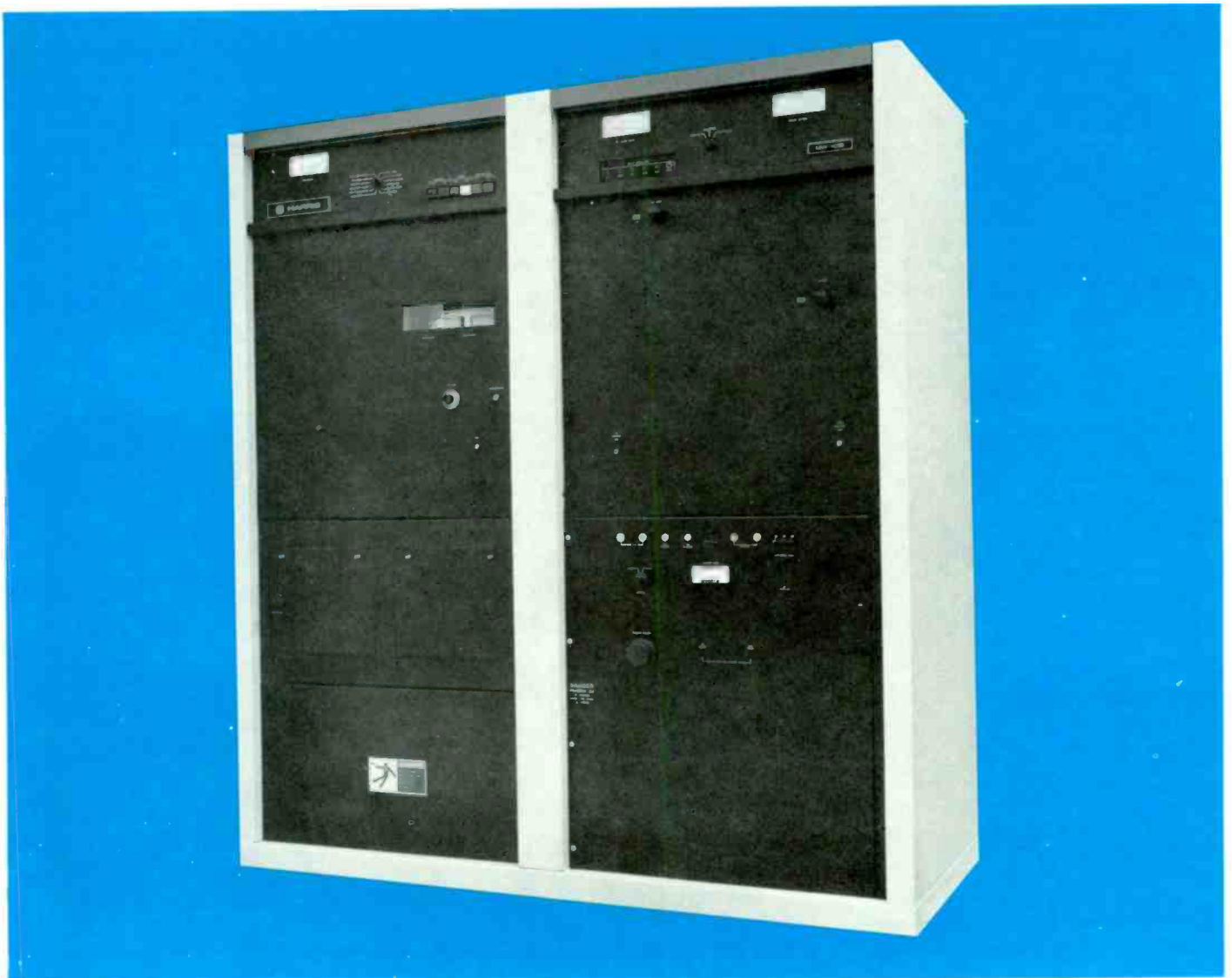

Harris' MW-10B...the world standard in 10 kW AM transmitters

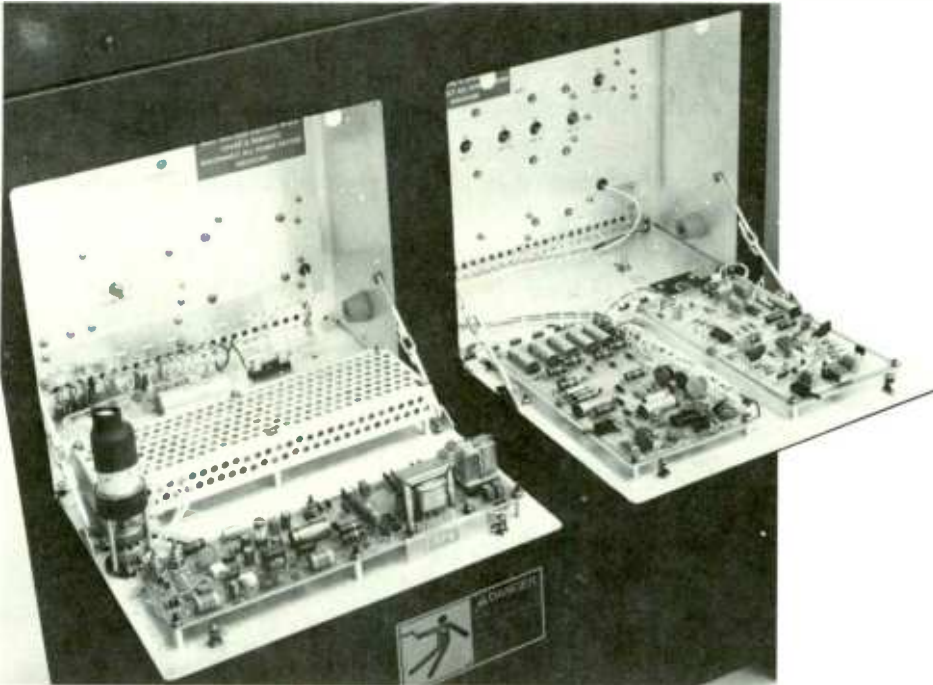

PDM and audio input chassis swing down for easy access.

The Harris MW-10B delivers overall performance superior to any other 10-kilowatt medium wave broadcast transmitter. The transmitter is high level plate modulated, using Harris' patented, highly efficient Pulse Duration Modulator (PDM). This, in combination with a number of other outstanding features, makes the MW-10B the most advanced 10-kilowatt AM transmitter in the world.

IMPROVED TRANSIENT RESPONSE

Installation of a high speed op-amp input stage has the same advantages as an audio input transformer—good isolation, impedance matching and common mode rejection. At the same time, the balanced op-amp input stage allows a dramatic improvement in transient response. The result: even more faithful reproduction of today's dynamic program material.

IMPROVED OVERTHOOT PERFORMANCE

Harris has incorporated an input Bessel filter that effectively *reduces* complex audio overshoots to a negligible level, without compromising any other audio specification. This improvement allows MW-10B users to increase their average modulation over the already high level characteristic of Harris' Pulse Duration Modulation. By selection of a single component, the high frequency response of the MW-10B may be tailored to best suit the station format.

HIGH OVERALL EFFICIENCY

The Pulse Duration Modulator employed in the MW-10B approaches 90% efficiency. This impressive modulator efficiency enables the transmitter to achieve an unusually high overall efficiency.

AUTOMATIC MODULATION TRACKING

Since incoming AC line voltages change radically during the course of the broadcast day, there is a direct effect on transmitter DC supply voltage, and hence power output. If the carrier power changes, over or under modulation may result, thus adversely affecting transmitter audio performance. The new MW-10B **Modulation Tracking Circuit** eliminates these problems by automatically maintaining the desired modulation level over a $\pm 20\%$ change in output power. This precision tracking circuit eliminates the need to purchase costly, single-function units requiring system interface.

THE MODULATION SYSTEM

Harris' Pulse Duration Modulator is characterized by low plate dissipation and low tube peak currents. Peak cathode currents are extremely low. Average plate dissipation runs substantially below rated levels, and all peak voltages are maintained well below component ratings. Conservative design allows a continuous 100% sine wave modulation rating.

IMPROVED SQUARE WAVE PERFORMANCE

With the addition of a new op-amp audio input stage, the MW-10B is now effectively DC coupled from the audio input to the RF power amplifier. This new circuit extends the transmitter's low end frequency response essentially to DC—approximately 2 Hz. Consequently, the MW-10B enjoys a noticeable improvement in square wave performance, with low frequency tilt nearly nonexistent.

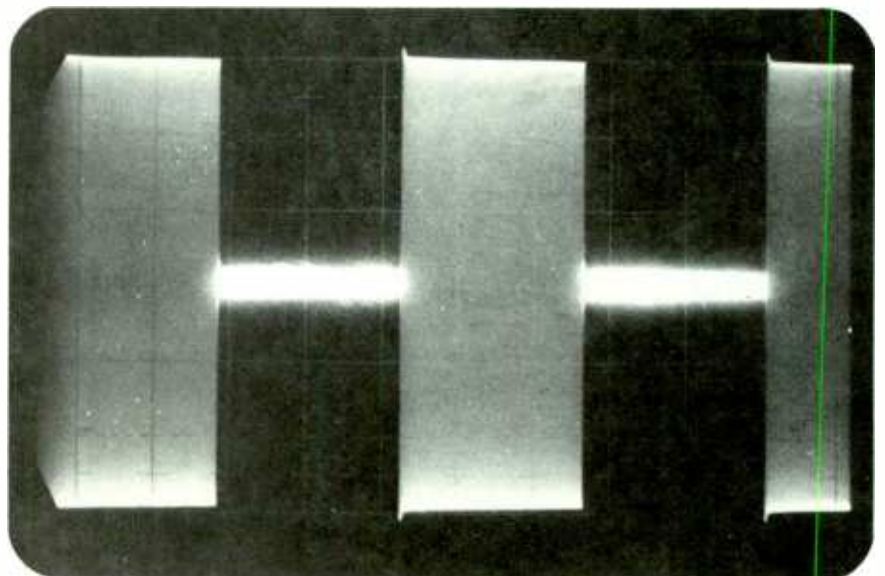

Wave form monitor showing excellent square wave response of MW-10B - 10 kW - 20 Hz at 95% Modulation

MW-10B features easy controls access.

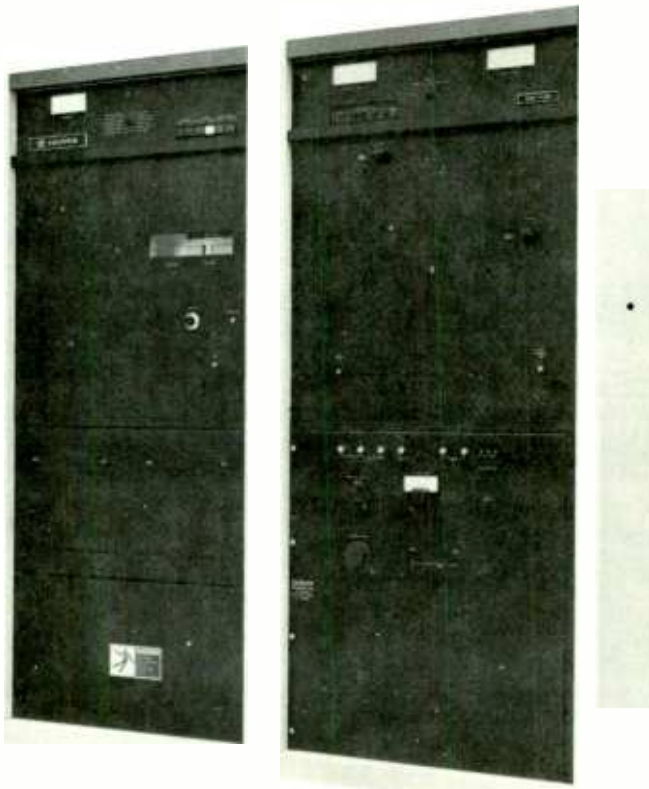

ONLY TWO TUBES... EXCEPTIONAL TUBE LIFE

The MW-10B employs just two tubes. The rugged ceramic 3CX15,000H3 triode power tube is used in the power amplifier. The Pulse Duration Modulator uses a 4CX15,000A. Use of just two tube types greatly simplifies spares stocking and associated spares costs. Highest quality components, conservatively rated, are used throughout the MW-10B to assure a maximum degree of reliability. Front panel metering and control enables filament voltage maintenance for maximum tube life.

CONTINUOUS 100% MODULATION RATING

This continuous sine wave modulation capability permits a higher average modulation to boost signal strength without increasing transmitted carrier power. The MW-10B provides 125% positive peak capability.

MAXIMUM CARRIER POWER 11 KILOWATTS

The Harris MW-10B provides a maximum carrier power of 11 kilowatts, allowing more reserve for driving directional arrays than other 10-kilowatt medium wave broadcast transmitters. DC and audio feedback insures overall transmitter stability. The MW-10B can be switched smoothly from high power to low power without loss of carrier,

thus minimizing annoying off-air power changes.

RF SECTION

The RF chain consists of two switchable crystals and oscillators, buffer, divider, RF amplifier, IPA, RF driver, and PA. Only 15 transistors are used in the entire RF chain.

The crystals and oscillators, buffer, divider and RF amplifier are located on one printed circuit board. The divider is a single IC which is socket mounted for easy replacement. Status LED indicators on the PC board show if voltage is available and if RF is being generated.

The IPA and RF driver are located on a swing-down chassis, and consist of five identical, high efficiency Class D, push-pull amplifier modules. One module is used in the IPA and four in the RF driver. The driver modules are connected so that, should one fail, the remaining three will provide adequate drive to keep the transmitter on the air at full power. Fault lamps indicate which of the modules failed. The PA operates in the highly efficient class D mode, yielding a plate efficiency approaching 90%.

PROTECTIVE CIRCUITS, STATUS CHANNELS

All major components of the MW-10B are protected by circuit breakers. Tubes and transistors are protected by overload relays or current limiting devices. Overloads are indicated on a LED fault status panel. A quick-acting circuit protects against dam-

age from high voltage arcs by limiting the energy in such arcs to 10 watt seconds.

Protection against voltage standing wave ratios of greater than 1.2 to 1.0 is provided. Both forward and reflected power are metered at the front panel. In case of momentary RF overloads, the MW-10B will recycle automatically. Should a repeated overload occur within a 30-second period, the transmitter will remain off until manually reset. However, if the time between overloads is greater than 30 seconds, continuous recycling will occur.

QUIET AIR COOLING

A standard three-quarter horsepower, single phase motor is used with a quiet, low-speed, belt-driven blower. Provisions are made on the top of the transmitter for ducting the exhaust air to the outside of the transmitter building.

DESIGNED FOR A WIDE RANGE OF CLIMATES

The MW-10B provides top performance in all types of climates, from hot and humid to dry and dusty. All transformers and similar components are hermetically sealed, encased, or vacuum impregnated.

TRANSMITTER LAYOUT

The MW-10B is completely self-contained in one cabinet—there are no external components.

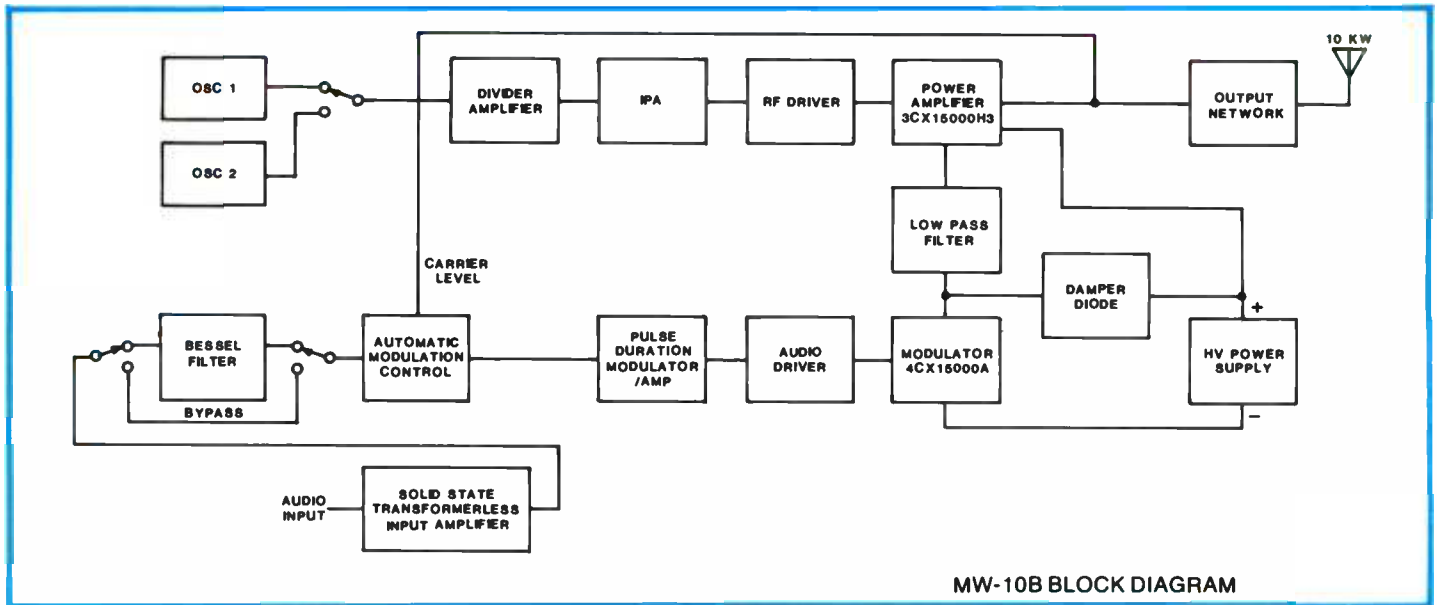

MW-10B SPECIFICATIONS

POWER OUTPUT: (Rated) 10,000 watts. (Capable) 11,000 watts. FCC type accepted at 10,000, 5000, 2500 and 1000 watts.

MODULATION METHOD: Pulse Duration Modulation.

CARRIER SHIFT: (@ 95% modulation with 400 Hz tone) 2% or less.

AUDIO INPUT: (For 95% modulation) +10 dBm, ± 2 dB.

AUDIO INPUT IMPEDANCE: 600 ohms balanced.

AUDIO FREQUENCY RESPONSE: ± 1 db, 20 to 10,000 Hz. (Response referred to 1 kHz, 95% modulation, with modulations at other frequencies held to same percentage. Response may degrade at higher modulating frequencies if transmitter is operated into a bandwidth limited antenna system.)

THD DISTORTION: ¹ 2% or less @ 95% modulation, 20 to 10,000 Hz unenhanced.

RF HARMONICS: Meets or exceeds FCC and CCIR requirements.

SPURIOUS OUTPUT: -80 dB or better.

RF FREQUENCY RANGE: 535 to 1605 kHz. Supplied to one frequency as ordered.

RF OUTPUT IMPEDANCE: 50 ohms, unbalanced. Other output impedances available on special order.

RF OUTPUT CONNECTOR: 1 $\frac{1}{2}$ -inch male EIA flange. Other types of output connectors available on special order.

MAXIMUM VSWR: 1.3 to 1.

NOISE: ² Unweighted, 60 dB below 100% modulation. Weighted (CCIR Rec. 468-1), 70 dB below 100% modulation.

POSITIVE PEAK CAPABILITY: 125% at 11 kW output, when modulated with processed program type material.

NEGATIVE PEAK CAPABILITY: 95%.

FREQUENCY STABILITY: ± 20 Hz or less over operating temperature range.

SUPPLY VOLTAGE: 200/500 volts, 3 phase, 60 Hz, closed delta/wye or 350/430 volts, 3 phase, 50 Hz, 4 wire wye.

LINE VOLTAGE REGULATION AND VARIATION: 5% maximum.

LINE VOLTAGE UNBALANCE: ² 4% maximum.

POWER CONSUMPTION (10 kW Carrier): ³ (Typical) 20.5 kW, 0% modulation; 22.1 kW, 50% tone modulation; 28.0 kW, 100% tone modulation. (Maximum) 22.1 kW, 0% modulation; 24.3 kW, 50% tone modulation; 30.8 kW, 100% tone modulation.

POWER FACTOR: 95% or better.

AMBIENT TEMPERATURE RANGE: ⁴ -20° to +50°C (-4° to +122°F) at sea level. Decreases 3.5° per 1,000 feet of altitude (84°F at 10,000 feet).

MAXIMUM RELATIVE HUMIDITY: 95%.

MAXIMUM ALTITUDE FOR FULL POWER RATING: 10,000 feet AMSL (3048 meters). Transmitters for operation above 10,000 feet AMSL require special order.

SIZE: ⁵ 78" H x 72" W x 32" D (198 cm x 183 cm x 81.3 cm).

WEIGHT: Unpacked, 1500 lbs. (680.4 kg) - approximate. Domestic packed, 1900 lbs. (861.8 kg) - approximate. Export packed, 2150 lbs. (975.2 kg) - approximate.

CUBAGE: 120 cu. ft. (3.4 cu. meters) packed - approximate.

FINISH: Blue, white and black.

TUBES USED: (1) 3CX15,000H3 and (1) 4CX15,000A.

REMOTE CONTROL: Normal terminal board interface.

1. Distortion measured at 95% modulation, or less, down to 25%. If transmitter is operated into a bandwidth limited antenna system, distortion at the higher modulating frequencies may degrade.
2. Noise measured over the band 20 Hz to 20 kHz, with line to line voltages of the supply line balanced. Noise may degrade to 56 dB below 100% modulation with line voltage unbalance not exceeding 4%.
3. Typical power consumption figures are for 10 kilowatts output and for optimum transmitter adjustment. For higher output powers and/or transmitter misadjustments, power consumption may be higher.
4. Maximum operating temperature derates linearly to +29°C (84.2°F) at 10,000 feet AMSL (3048 meters).
5. Does not include height of output connector, which may be removed for transport.

SPECIFICATIONS SUBJECT TO CHANGE WITHOUT NOTICE.

ORDERING INFORMATION

MW-10B Transmitter with one set of operating tubes and two crystals, for 200-250 Volts or 350-430 Volts, 3 phase, 60 Hz operation994-8624-004

MW-10B Transmitter with one set of operating tubes and two crystals, for 200-250 Volts or 350-430 Volts, 3 phase, 50 Hz operation994-8624-006

Recommended spare semiconductor kit990-1018-001

Low voltage and filament voltage regulator, and line voltage regulator for MW-10B available.



HARRIS

SX-5

5000 Watt
All-Solid-State
Medium Wave
Broadcast Transmitter

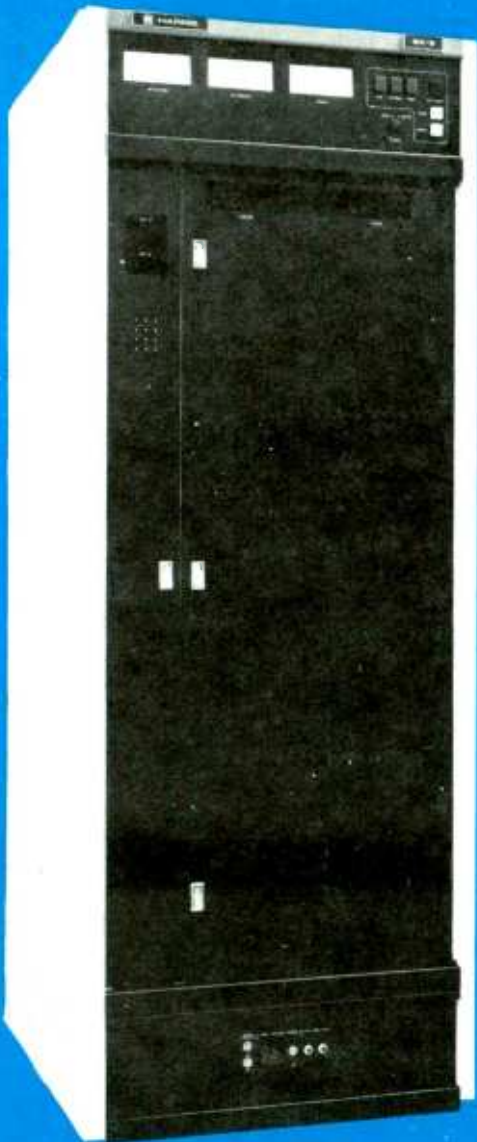

- 100% solid state for highest reliability
- Overall efficiency exceeds 75%
- Polyphase PDM* for exceptional audio performance
- New concept dual microprocessor control and status monitoring eases operation and simplifies service
- Flat-Pass output network for exceptional phase and amplitude linearity
- Exceptional performance in monaural or stereo (optional)
- Unique air handling system lowers maintenance

*Patented

The Harris SX-5 is based on a rigid design philosophy applied to the entire SX Series of solid-state AM transmitters. Central to this concept are the commitments to achieve:

- a) The highest possible audio performance
- b) The highest possible overall efficiency
- c) Maximum reliability

The SX-5 broadcast transmitter is all-new, and it's in a class by itself. It is computer designed and computer tested, with its own self-contained dual status and control computers. The SX-5 is 100% solid state and not affected by loss of emission, shorted elements or other related problems found in tube type transmitters.

EFFICIENT POWER DEVICES

With the new SX Series of transmitters, Harris introduces new high power semi-conductor technology to its broadcast products. State-of-the-art MOSFET transistors, as opposed to bipolar devices, achieve higher efficiency in the SX-5.

WHY MOSFETS?

MOSFETS (Metal Oxide Semiconductor Field Effect Transistors) represent a second generation of power devices offering significant benefits over bipolar transistor technology. Combined with the circuits used in the SX-5, MOSFETS prove to be extremely efficient. Unlike bipolar devices, MOSFETS are not subject to thermal runaway damage and are used both in the modulator and PA stages of the SX-5.

Harris SX-5

High technology in a blend of broadcast and computer science

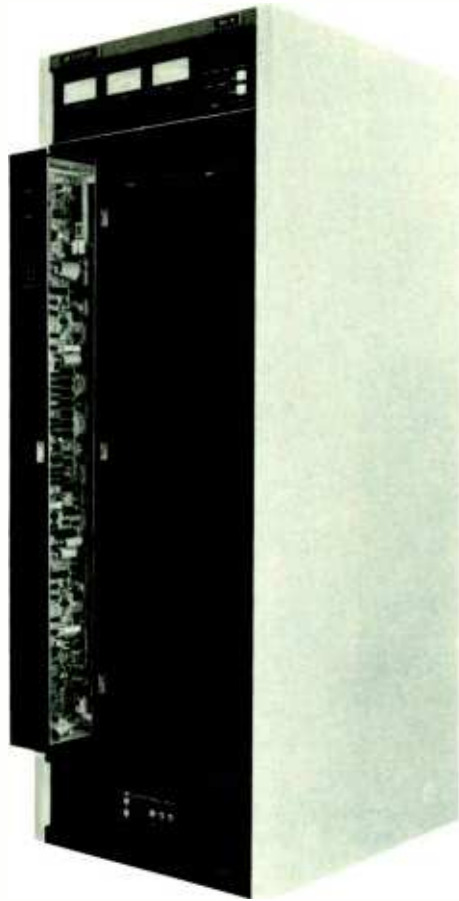

Low level plug-in circuit boards are conveniently housed on a vertical slide-out drawer for easy maintenance.

Additionally, MOSFET transistors lend themselves to parallel operation where multiple devices are required. In the Harris design, the transistors in the power amplifier modules are operated in parallel for DC. But unlike other transmitters, the ferrite combiner places the amplifiers in series, permitting graceful degradation without increasing the stress on the remaining transistors.

HIGHLY EFFICIENT POWER AMPLIFIER

The SX-5 contains four RF power amplifier modules conservatively rated to produce 5600 watts output. The MOSFETs are grouped in a quad configuration and combined in a low loss series configured ferrite combiner. Harris' PA module design efforts have resulted in an overall PA efficiency exceeding 90%.

POLYPHASE PDM MODULATION

Polyphase PDM is a significant improvement of the Harris Pulse Duration

Modulation system. It is a 4-phase system in which the audio input is sampled four times during each PDM cycle, resulting in lower harmonic and intermodulation distortion.

The combination of the Harris Polyphase PDM Modulation and MOSFET devices achieves a modulator efficiency exceeding 94%. Polyphase PDM also allows the low pass filter to have a wide audio passband, reducing overshoot on sharply rising waveforms. This provides the ability to achieve higher levels of modulation density. Should there be a malfunction of one phase of the system, operation continues at reduced power until a convenient maintenance period can be scheduled. Harris' Polyphase PDM achieves new levels of AM audio performance and reliability.

EXCEPTIONALLY HIGH OVERALL EFFICIENCY

The exceptionally high PA and mod-

ulator efficiency of the SX-5 combine to yield greater than 75% overall AC to RF efficiency. This represents a 15% to 36% direct power saving compared with other 5 kW transmitters now in use!

FLAT-PASS OUTPUT NETWORK

After examining various output networks in past and current transmitters, Harris chose an output network/bandpass filter consistent with the design objectives of the SX-5. The computer designed *Flat-Pass* output network is a Butterworth bandpass filter yielding superb phase and amplitude linearity—two critical requirements for optimum AM Stereo performance.

The innovative design of the *Flat-Pass* network allows modulation monitoring and forward power to be measured at a fixed impedance. The directional coupler is always located at a 50 ohm impedance point. Direct drive tuning and loading controls simply adjust the SX-5 to match a load that can be any value within a 1.5:1 VSWR circle.

High speed lightning protection results from design techniques and devices used in the SX-5. The transmitter constantly monitors VSWR status and takes action only when long-term operational limits are exceeded. Premature VSWR trips, due to station problems or other environmental factors, are eliminated. Should a long-term mismatch condition exist, the transmitter simply reduces output power to a tolerable level, remaining on the air. *The transmitter will not be damaged when operated into an open or shorted load even at full output power!*

DUAL MICROPROCESSOR CONTROL AND STATUS MONITORING

Harris' extensive experience in transmitter technology and digital based products (program automation, automatic camera setup, facility control) permits the incorporation of powerful control and diagnostic features into the SX-5 transmitter. Should a multiple overload occur, the operator may review stored previous meter readings and sequential status indications to determine the fault. A vast number of useful operating parameters is available at fingertip command at the front panel keypad, making the SX-5 one of the easiest transmitters to monitor, control and service. The controller is

Pushbutton diagnostics!

The SX-5 transmitter brings a wealth of diagnostic information to your fingertips through the microprocessor keypad located on the front panel.



pre-programmed at the factory and only requires interrogation by the operator.

The transmitter's control and status functions are shared by two microprocessor controller boards working in tandem. Should one unit fail, the other microprocessor automatically picks up the additional duties without interruption. A simple logic probe is included with the SX-5 to assist the operator in checking simple digital circuitry controlled by the microprocessors.

Operationally, the SX-5 consists of three eye-level meters displaying PA Volts, PA Current and Forward/Reflected Power. To the right of these large, easy-to-read meters are six illuminated pushbuttons labeled as follows:

Off-Fault—This pushbutton not only turns the transmitter off, but also acts as a master status light in the event of a transmitter malfunction. Extensive control module LED indicators assist the operator in isolating the fault.

Low, Medium and High—Independent tri power levels can be set to any value for each of the three power control buttons. The illuminated button indicates

which power level is operating. No contactor or power transformer tap changes are required.

Raise Power-Lower Power—These pushbuttons allow the operator to set and adjust the power levels. This is a digital power control and has no moving parts.

CUSTOMER INTERFACE PANEL

The Customer Interface Panel provides the user with a centrally located point for all external interface equipment such as remote control, facility control, audio input, etc. The SX-5 transmitter is designed to interface with the majority of remote control and facility control systems. A momentary closure of 100 milliamps rating (TTL or dry contact) will activate the various control functions. All analog samples (PA volts, PA current, output power, etc.) are buffered.

DESIGNED FOR AM STEREO

The SX-5 is designed for AM Stereo, with special consideration paid to incidental phase modulation, audio input to RF envelope output phase linearity, and RF channel phase response. The standard high stability crystal oscillator and optional frequency synthesizer are both equipped to accept external AM Stereo RF oscillator signals.

MECHANICAL DESIGN CONSIDERATIONS

Service accessibility is a major user benefit of the SX-5. This is accomplished by novel electronic packaging new to broadcast transmitter products. For example, all low level circuit cards such as the RF oscillator, control logic and Polyphase PDM generator cards are located in a pull-out drawer. All critical low level circuit tests can be made while on the air.

The all aluminum cabinet construction reduces shipping cost, while captive hardware and connectorized module interfaces reduce maintenance time.

COOLING SYSTEM

The SX-5 is the first broadcast transmitter incorporating innovative cooling techniques that significantly reduce maintenance. The transmitter dissipates only 2000 watts of heat. This has allowed Harris to utilize a computer modeled convection cooling technique that offers significant benefits over conventional cooling methods.

The sidewalls of the transmitter form "chimneys" to which the power amplifier modules are attached. Air assisted by a high reliability fan enters through a filtered rear or bottom inlet and rises through the cabinet walls, cooling the power module's heat sinks. The majority of this convection cooling air passes through the isolated chimneys, with only a small amount of air required to flush the inside of the cabinet. Since the majority of the air does not come in contact with the electronic components, maintenance is greatly reduced.

EASE OF INSTALLATION AND SERVICE

The SX-5 arrives ready for installation. Included is a wall mounted AC disconnect panel designed to interface with the station's electrical distribution system. Installation is as simple as positioning the SX-5 and making final AC, RF and audio connections. No special air handling systems are required in most installations.

TODAY'S TRANSMITTER FOR TODAY'S BROADCASTER

Exceptionally high overall efficiency; maximum reliability; improved audio performance; full service microprocessor control and status monitoring; *readiness for AM Stereo*—these are just a few of the features in the SX-5 broadcast transmitter. Never before has Harris incorporated as many benefits in today's transmitter for today's broadcaster.

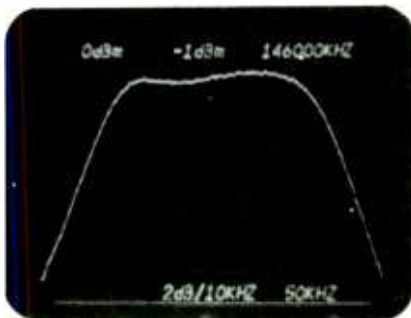

Spectrum analyzer response of Flat-Pass output network maximizes mono and stereo performance.

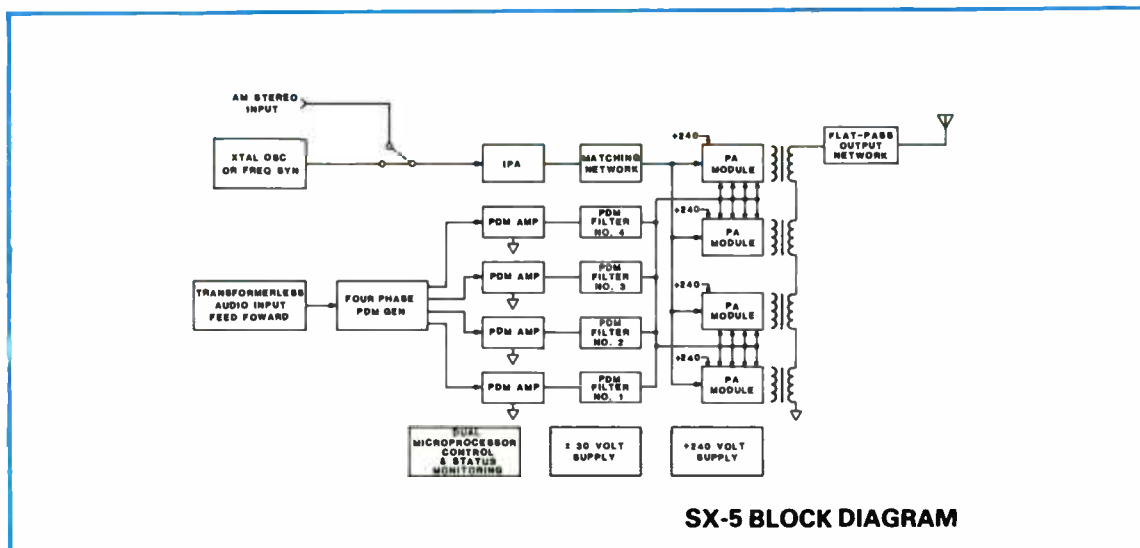

SX-5 SPECIFICATIONS

POWER OUTPUT: (Rated) 5000 watts. (Capable) 5600 watts. Power reduction through 500 watts.

RF FREQUENCY RANGE: 540 KHz through 1700 KHz. Supplied to one frequency as ordered.

CARRIER FREQUENCY STABILITY: A) Crystal Oscillator — ± 20 Hz over temperature range. B) Frequency Synthesizer (optional) — ± 10 Hz over temperature range.

RF OUTPUT IMPEDANCE: 50 ohms unbalanced. Will match into a VSWR of 1.5:1 at carrier.

RF OUTPUT TERMINAL: $\frac{3}{8}$ " EIA male flange connector.

CARRIER AMPLITUDE VARIATION: (Carrier Shift): Less than 2% at 100% modulation.

RF HARMONICS: Exceeds FCC and CCIR specifications.

TYPE OF MODULATOR: Patented Polyphase PDM.

AUDIO FREQUENCY RESPONSE: ± 1 dB from 20 to 12,500 Hz.

AUDIO HARMONIC DISTORTION: 1.5% or less at 5 kW, 20 to 12,500 Hz @ 95% modulation. 2.0% or less at 1000 watts operation, 20 to 12,500 Hz @ 95% modulation.

AUDIO INTERMODULATION DISTORTION: 1.0% or less at 5 kW, 60/7000 Hz 1:1, 3.0% or less, 60/7000 Hz 4:1 SMPTE standards at 80% modulation.

SQUAREWAVE OVERSHOOT: Less than 3% at 400 Hz.

SQUAREWAVE TILT: Less than 2% at 400 Hz.

NOISE (UNWEIGHTED): Better than 60 dB below 100% modulation.

POSITIVE PEAK CAPABILITY: 125% positive peak program modulation capability at 5600 watts.

AM STEREO SPECIFICATIONS: A) Incidental Phase: 0.2 Average (Radians); 0.5 Peak (Radians). B) RF Channel Phase Response (External Input to RF Output): 4%, ± 20 KHz of carrier power. 8%, ± 30 KHz of carrier power.

AUDIO INPUT: -10 to +10 dBm, transformerless 600 ohms balanced, continuously adjustable.

AC VOLTAGE INPUT: 197-251 VAC, 48 to 63 Hz, three phase, delta. 341-434 VAC, 48 to 63 Hz, three phase wye, 4 wire (not recommended for connection to open delta power source).

PA EFFICIENCY: Better than 90%.

OVERALL EFFICIENCY: Better than 75%.

POWER CONSUMPTION: 6.7 kW at 0% modulation at 5000 watts carrier. 10.0 kW at 100% tone modulation at 5000 watts carrier. 9.0 kW under average programming conditions.

SPURIOUS OUTPUT: Exceeds FCC and CCIR requirements.

MONITOR PROVISIONS: 10 volts RF (RMS) modulated output sample at 50 ohms (High/Medium/Low) power.

REMOTE CONTROL: Self-contained interface for most remote control or facility control systems.

AMBIENT TEMPERATURE RANGE: -20°C to +50°C (derate upper limit 2°C per 1000 feet altitude).

AMBIENT HUMIDITY RANGE: To 95% non condensing.

AIR FLOW: 150 CFM, either rear or bottom inlet.

ALTITUDE: Sea Level to 13,000 feet (4000 meters).

OPERATING ACOUSTICAL NOISE: Better than 53 dBA.

SIZE: 72"H x 28"W x 30"D (1830 mm x 712 mm x 762 mm).

WEIGHT: (Unpacked), 500 lbs. (230 kg) — approximate. Domestic packed, 700 lbs. (320 kg) — approximate. Export packed, 800 lbs. (370 kg) — approximate.

CUBAGE: 68.7 cubic feet (2 cubic meters) packed.

COLORS: Black, white and blue.

TYPE OF ACTIVE COMPONENTS: 100% solid state.

POWER SUPPLY: Three phase full wave self-contained, dry.

SPECIFICATIONS SUBJECT TO CHANGE WITHOUT NOTICE

¹ For AC service connection, please provide 12 KVA with a minimum of 5% voltage demand regulation.

NOTE: The above audio performance may be degraded should the transmitter be operated into a bandwidth restricted antenna system.

ORDERING INFORMATION

SX-5 Transmitter, complete with all solid-state devices, crystal oscillator, technical manual.	
Specify frequency994-8583-001
SX-5 Transmitter, complete with all solid-state devices, frequency synthesizer, technical manual.	
Specify frequency994-8583-003
Recommended spare semiconductor kit990-1014-001
Spare crystal444-XXXX-000
ANCILLARY EQUIPMENT	
AM-90 modulation monitor994-8424-001
AF-80 frequency monitor994-6698-001
Potomac AT-51 test set700-0499-000
MSP-90 tri band AGC amplifier994-8357-001
MSP-90 AM limiter994-8200-001



HARRIS

SX-2.5

2500 Watt
All-Solid-State
Medium Wave
Broadcast Transmitter

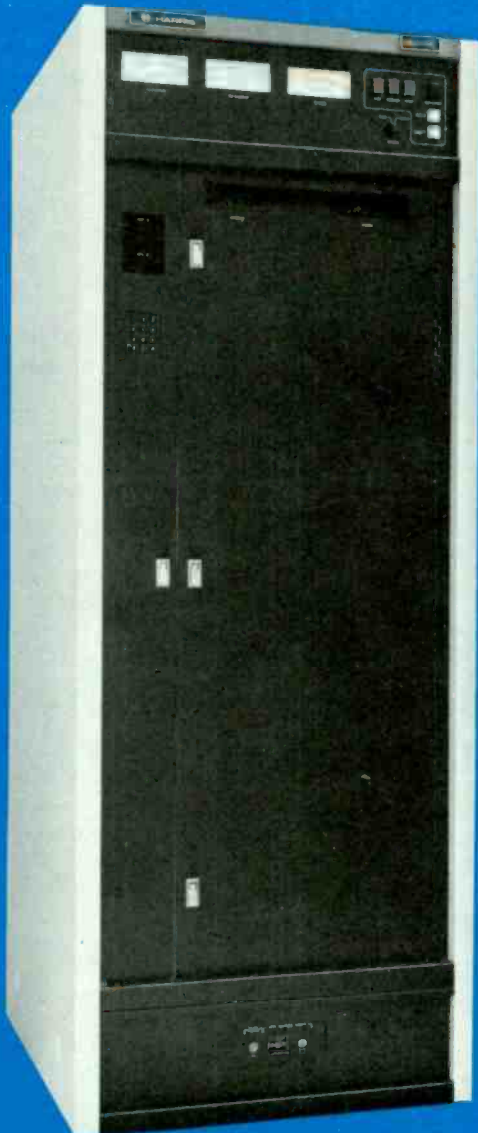

- 100% solid state for highest reliability
- Overall efficiency exceeds 72%
- Polyphase PDM* for exceptional audio performance
- New concept dual microprocessor control and status monitoring eases operation and simplifies service
- Flat-Pass output network for exceptional phase and amplitude linearity
- Optional field upgrade to 5 kW
- Exceptional performance in monaural or stereo (optional)
- Unique air handling system lowers maintenance

*Patented

The Harris SX-2.5 is based on a rigid design philosophy applied to the entire SX Series of solid-state AM transmitters. Central to this concept are the commitments to achieve:

- a) The highest possible audio performance
- b) The highest possible overall efficiency
- c) Maximum reliability

The SX-2.5 broadcast transmitter is all-new, and it's in a class by itself. It is computer designed and computer tested, with its own self-contained dual status and control computers. The SX-2.5 is 100% solid state and not affected by loss of emission, shorted elements or other related problems found in tube type transmitters.

EFFICIENT POWER DEVICES

With the new SX Series of transmitters, Harris introduces new high power semi-conductor technology to its broadcast products. State-of-the-art MOSFET transistors, as opposed to bipolar devices, achieve higher efficiency in the SX-2.5.

WHY MOSFETS?

MOSFETS (Metal Oxide Semiconductor Field Effect Transistors) represent a second generation of power devices offering significant benefits over bipolar transistor technology. Combined with the circuits used in the SX-2.5, MOSFETS prove to be extremely efficient. Unlike bipolar devices, MOSFETS are not subject to thermal runaway damage and are used both in the modulator and PA stages of the SX-2.5.

Harris SX-2.5

High technology in a blend of broadcast and computer science

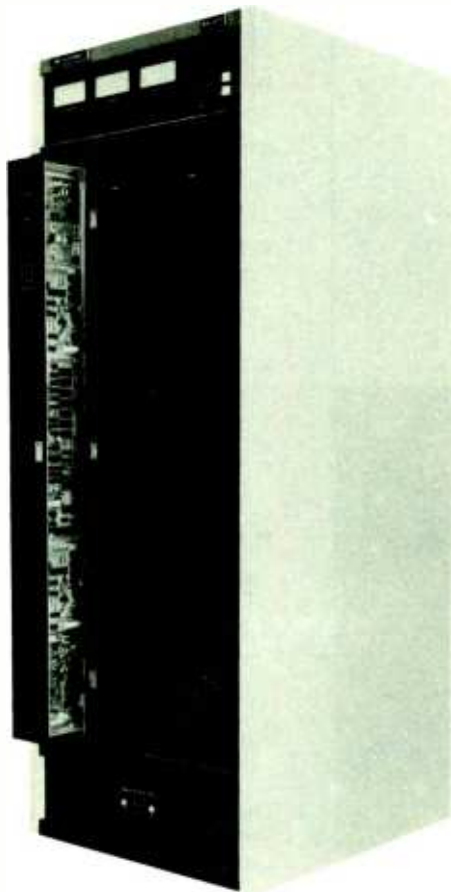

Low level plug-in circuit boards are conveniently housed on a vertical slide-out drawer for easy maintenance.

Additionally, MOSFET transistors lend themselves to parallel operation where multiple devices are required. In the Harris design, the transistors in the power amplifier modules are operated in parallel for DC. But unlike other transmitters, the ferrite combiner places the amplifiers in series, permitting graceful degradation without increasing the stress on the remaining transistors.

HIGHLY EFFICIENT POWER AMPLIFIER

The SX-2.5 contains two RF power amplifier modules conservatively rated to produce 2750 watts output. The MOSFETS are grouped in a quad configuration and combined in a low loss series configured ferrite combiner. Harris' PA module design efforts have resulted in an overall PA efficiency exceeding 90%.

POLYPHASE PDM MODULATION

Polyphase PDM is a significant improvement of the Harris Pulse Duration

Modulation system. It is a 4-phase system in which the audio input is sampled four times during each PDM cycle, resulting in lower harmonic and intermodulation distortion.

The combination of the Harris Polyphase PDM Modulation and MOSFET devices achieves a modulator efficiency exceeding 94%. Polyphase PDM also allows the low pass filter to have a wide audio passband, reducing overshoot on sharply rising waveforms. This provides the ability to achieve higher levels of modulation density. Should there be a malfunction of one phase of the system, operation continues at reduced power until a convenient maintenance period can be scheduled. Harris' Polyphase PDM achieves new levels of AM audio performance and reliability.

EXCEPTIONALLY HIGH OVERALL EFFICIENCY

The exceptionally high PA and mod-

ulator efficiency of the SX-2.5 combine to yield greater than 72% overall AC to RF efficiency. This represents a 40% to 47% direct power saving compared with other 2.5 kW transmitters now in use!

FLAT-PASS OUTPUT NETWORK

After examining various output networks in past and current transmitters, Harris chose an output network/bandpass filter consistent with the design objectives of the SX-2.5. The computer designed *Flat-Pass* output network is a Butterworth bandpass filter yielding superb phase and amplitude linearity—two critical requirements for optimum AM Stereo performance.

The innovative design of the *Flat-Pass* network allows modulation monitoring and forward power to be measured at a fixed impedance. The directional coupler is always located at a 50 ohm impedance point. Direct drive tuning and loading controls simply adjust the SX-2.5 to match a load that can be any value within a 1.5:1 VSWR circle.

High speed lightning protection results from design techniques and devices used in the SX-2.5. The transmitter constantly monitors VSWR status and takes action only when long-term operational limits are exceeded. Premature VSWR trips, due to station problems or other environmental factors, are eliminated. Should a long-term mismatch condition exist, the transmitter simply reduces output power to a tolerable level, remaining on the air. *The transmitter will not be damaged when operated into an open or shorted load even at full output power!*

DUAL MICROPROCESSOR CONTROL AND STATUS MONITORING

Harris' extensive experience in transmitter technology and digital based products (program automation, automatic camera setup, facility control) permits the incorporation of powerful control and diagnostic features into the SX-2.5 transmitter. Should a multiple overload occur, the operator may review stored previous meter readings and sequential status indications to determine the fault. A vast number of useful operating parameters is available at fingertip command at the front panel keypad, making the SX-2.5 one

Pushbutton diagnostics!

The SX-2.5 transmitter brings a wealth of diagnostic information to your fingertips through the microprocessor keypad located on the front panel.

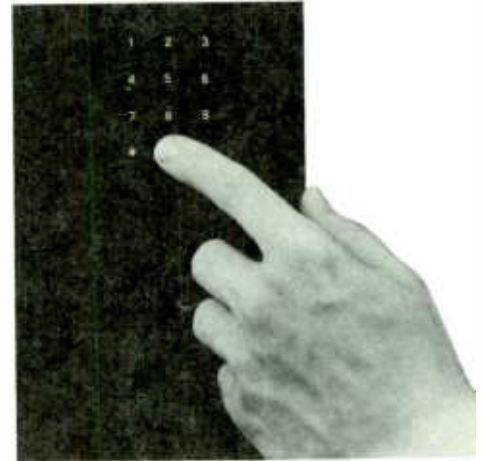

of the easiest transmitters to monitor, control and service. The controller is pre-programmed at the factory and only requires interrogation by the operator.

The transmitter's control and status functions are shared by two microprocessor controller boards working in tandem. Should one unit fail, the other microprocessor automatically picks up the additional duties without interruption. A simple logic probe is included with the SX-2.5 to assist the operator in checking simple digital circuitry controlled by the microprocessors.

Operationally, the SX-2.5 consists of three eye-level meters displaying PA Volts, PA Current and Forward/Reflected Power. To the right of these large, easy-to-read meters are six illuminated pushbuttons labeled as follows:

Off-Fault—This pushbutton not only turns the transmitter off, but also acts as a master status light in the event of a transmitter malfunction. Extensive control module LED indicators assist the operator in isolating the fault.

Low, Medium and High—Independent tri power levels can be set to any value for each of the three power control but-

tons. The illuminated button indicates which power level is operating. No contactor or power transformer tap changes are required.

Raise Power-Lower Power—These pushbuttons allow the operator to set and adjust the power levels. This is a digital power control and has no moving parts.

CUSTOMER INTERFACE PANEL

The Customer Interface Panel provides the user with a centrally located point for all external interface equipment such as remote control, facility control, audio input, etc. The SX-2.5 transmitter is designed to interface with the majority of remote control and facility control systems. A momentary closure of 100 milliamps rating (TTL or dry contact) will activate the various control functions. All analog samples (PA volts, PA current, output power, etc.) are buffered.

DESIGNED FOR AM STEREO

The SX-2.5 is designed for AM Stereo, with special consideration paid to incidental phase modulation, audio input to RF envelope output phase linearity, and RF channel phase response. The standard high stability crystal oscillator and optional frequency synthesizer are both equipped to accept external AM Stereo RF oscillator signals.

MECHANICAL DESIGN CONSIDERATIONS

Service accessibility is a major user benefit of the SX-2.5. This is accomplished by novel electronic packaging new to broadcast transmitter products. For example, all low level circuit cards such as the RF oscillator, control logic and Polyphase PDM generator cards are located in a pull-out drawer. All critical low level circuit tests can be made while on the air.

The all aluminum cabinet construction reduces shipping cost, while captive hardware and connectorized module interfaces reduce maintenance time.

COOLING SYSTEM

The SX-2.5 is the first broadcast transmitter incorporating innovative cooling techniques eliminating the need for a blower or fan. The transmitter dissipates only 1000 watts of heat. This has allowed Harris to utilize a computer modeled convection cooling technique that offers significant benefits over conventional cooling methods.

The sidewalls of the transmitter form "chimneys" to which the power amplifier modules are attached. Air enters through a filtered rear entrance and rises through the cabinet walls, cooling the power module's heat sinks. The majority of this convection cooling air passes through the isolated chimneys, with only a small amount of air required to flush the inside of the cabinet. Since no blower is required, and the majority of the air does not come in contact with the electronic components, maintenance and noise are greatly reduced.

EASE OF INSTALLATION AND SERVICE

The SX-2.5 arrives ready for installation. Included is a wall mounted AC disconnect panel designed to interface with the station's electrical distribution system. Installation is as simple as positioning the SX-2.5 and making final AC, RF and audio connections. No special air handling systems are required.

TODAY'S TRANSMITTER FOR TODAY'S BROADCASTER

Exceptionally high overall efficiency; maximum reliability; improved audio performance; full service microprocessor control and status monitoring; field upgrading to 5 kW; *readiness for AM Stereo*—these are just a few of the features in the SX-2.5 broadcast transmitter. Never before has Harris incorporated as many benefits in today's transmitter for today's broadcaster.

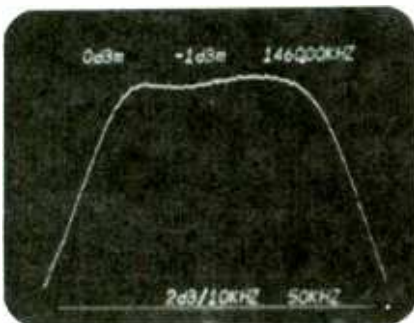

Spectrum analyzer response of Flat-Pass output network maximizes mono and stereo performance.

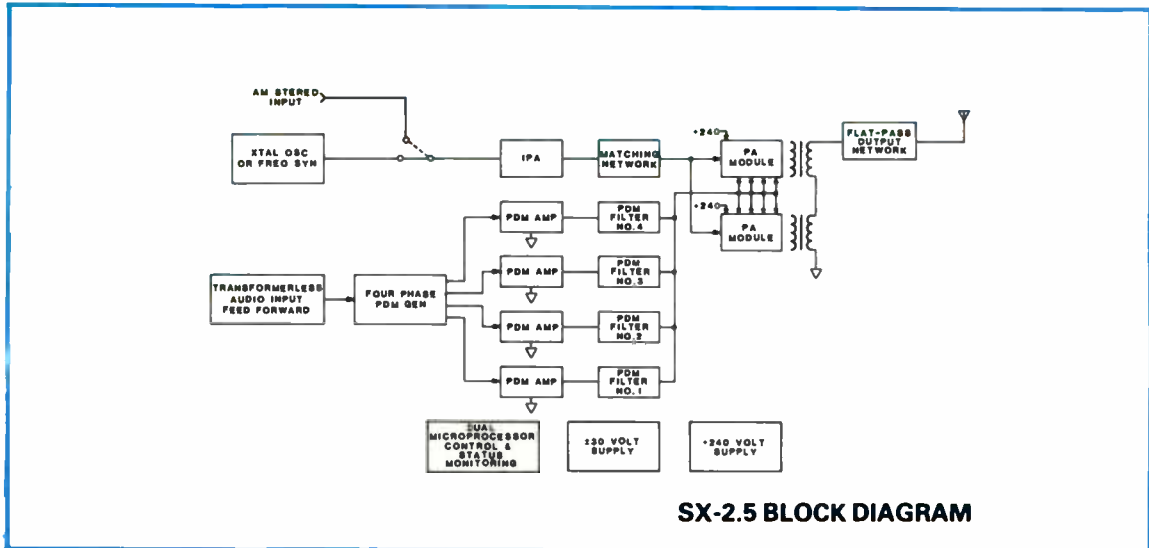

SX-2.5 SPECIFICATIONS

POWER OUTPUT: (Rated) 2500 watts. (Capable) 2750 watts. Power reduction through 500 watts.

RF FREQUENCY RANGE: 540 KHz through 1700 KHz. Supplied to one frequency as ordered.

CARRIER FREQUENCY STABILITY: A) Crystal Oscillator — ± 20 Hz over temperature range. B) Frequency Synthesizer (optional) — ± 10 Hz over temperature range.

RF OUTPUT IMPEDANCE: 50 ohms unbalanced. Will match into a VSWR of 1.5:1 at carrier.

RF OUTPUT TERMINAL: $\frac{3}{8}$ " EIA male flange connector.

CARRIER AMPLITUDE VARIATION: (Carrier Shift): Less than 2% at 100% modulation.

RF HARMONICS: Exceeds FCC and CCIR specifications.

TYPE OF MODULATOR: Patented Polyphase PDM.

AUDIO FREQUENCY RESPONSE: ± 1 dB from 20 to 12,500 Hz.

AUDIO HARMONIC DISTORTION: 1.5% or less at 2.5 kW, 20 to 12,500 Hz @ 95% modulation. 2.0% or less at 500 watt operation, 20 to 12,500 Hz @ 95% modulation.

AUDIO INTERMODULATION DISTORTION: 1.0% or less at 2.5 kW, 60/7000 Hz 1:1, 3.0% or less, 60/7000 Hz 4:1 SMPTE standards at 80% modulation.

SQUAREWAVE OVERSHOOT: Less than 3% at 400 Hz.

SQUAREWAVE TILT: Less than 2% at 400 Hz.

NOISE (UNWEIGHTED): Better than 60 dB below 100% modulation.

POSITIVE PEAK CAPABILITY: 125% positive peak program modulation capability at 2750 watts.

AM STEREO SPECIFICATIONS: A) Incidental Phase: 0.2 Average (Radians); 0.5 Peak (Radians). B) RF Channel Phase Response (External Input to RF Output): 4%, ± 20 KHz of carrier power. 8%, ± 30 KHz of carrier power.

AUDIO INPUT: -10 to +10 dBm, transformerless 600 ohms balanced, continuously adjustable.

AC VOLTAGE INPUT: 197-251 VAC, 48 to 63 Hz, single phase.

PA EFFICIENCY: Better than 90%.

OVERALL EFFICIENCY: Better than 72%.

POWER CONSUMPTION¹: 3.5 kW at 0% modulation at 2500 watts. 5.3 kW at 100% tone modulation at 2500 watts carrier. 4.5 kW under average programming conditions.

SPURIOUS OUTPUT: Exceeds FCC and CCIR requirements.

MONITOR PROVISIONS: 10 volts RF (RMS) modulated output sample at 50 ohms (High/Medium/Low) power.

REMOTE CONTROL: Self-contained interface for most remote control or facility control systems.

AMBIENT TEMPERATURE RANGE: -20°C to +50°C (derate upper limit 2°C per 1000 feet altitude).

AMBIENT HUMIDITY RANGE: To 95% non condensing.

AIR FLOW: Free convection.

ALTITUDE: Sea Level to 13,000 feet (4000 meters).

OPERATING ACOUSTICAL NOISE: Better than 45 dBA.

SIZE: 72"H x 28"W x 30"D (1830 mm x 712 mm x 762 mm).

WEIGHT: (Unpacked), 450 lbs. (204 kg) — approximate. Domestic packed, 650 lbs. (298 kg) — approximate. Export packed, 750 lbs. (343 kg) — approximate.

CUBAGE: 68.7 cubic feet (2 cubic meters) packed.

COLORS: Black, white and blue.

TYPE OF ACTIVE COMPONENTS: 100% solid state.

POWER SUPPLY: Self-contained, dry.

SPECIFICATIONS SUBJECT TO CHANGE WITHOUT NOTICE

¹ For AC service connection, please provide 7.6 KVA with a minimum of 5% voltage demand regulation.

NOTE: The above audio performance may be degraded should the transmitter be operated into a bandwidth restricted antenna system.

ORDERING INFORMATION

SX-2.5 Transmitter, complete with all solid-state devices, crystal oscillator, technical manual.	
Specify frequency994-8582-001 *
SX-2.5 Transmitter, complete with all solid-state devices, frequency synthesizer, technical manual.	
Specify frequency994-8582-003 *
Recommended spare semiconductor kit990-1013-001
Spare crystal444-XXXX-000
ANCILLARY EQUIPMENT	
AM-90 modulation monitor994-8424-001
AF-80 frequency monitor994-6698-001
Potomac AT-51 test set700-0499-000
MSP-90 tri band AGC amplifier994-8357-001
MSP-90 AM limiter994-8200-001

* Contact Harris for special ordering information and details on the optional power upgradable SX-2.5.



HARRIS

SX-1 1000 Watt All-Solid-State Medium Wave Broadcast Transmitter

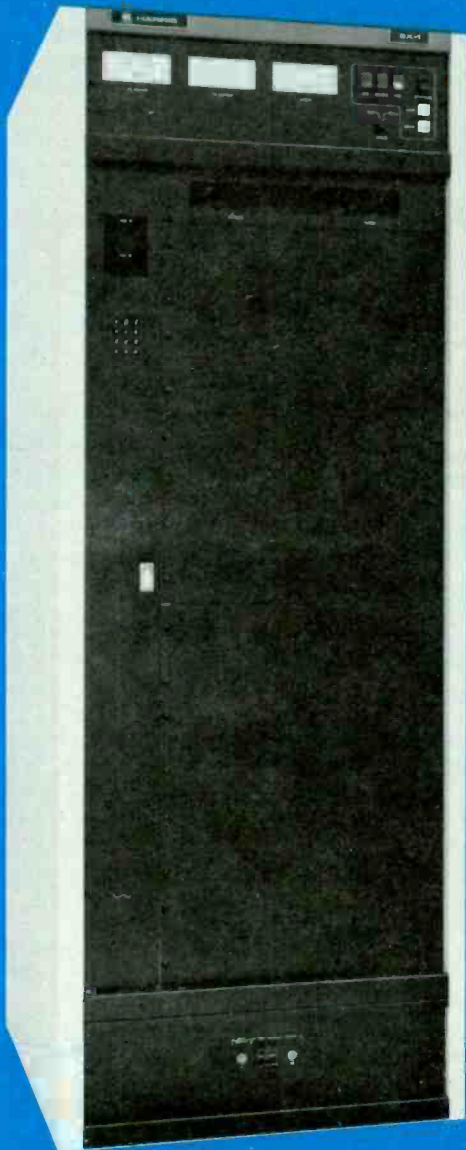

- 100% solid state for highest reliability
- Overall efficiency exceeds 72%
- Polyphase PDM* for exceptional audio performance
- New concept dual microprocessor control and status monitoring eases operation and simplifies service
- *Flat-Pass* output network for exceptional phase and amplitude linearity
- Optional field upgrade to 2.5 kW or 5 kW
- Exceptional performance in monaural or stereo (optional)
- 36 inches of internal rack space provided for ancillary equipment
- Unique air handling system lowers maintenance

*Patented

The Harris SX-1 is based on a rigid design philosophy applied to the entire SX Series of solid-state AM transmitters. Central to this concept are the commitments to achieve:

- a) The highest possible audio performance
- b) The highest possible overall efficiency
- c) Maximum reliability

The SX-1 broadcast transmitter is all-new, and it's in a class by itself. It is computer designed and computer tested, with its own self-contained dual status and control computers. The SX-1 is 100% solid state and not affected by loss of emission, shorted elements or other related problems found in tube type transmitters.

EFFICIENT POWER DEVICES

With the new SX Series of transmitters, Harris introduces new high power semi-conductor technology to its broadcast products. State-of-the-art MOSFET transistors, as opposed to bipolar devices, achieve higher efficiency in the SX-1.

WHY MOSFETS?

MOSFETS (Metal Oxide Semiconductor Field Effect Transistors) represent a second generation of power devices offering significant benefits over bipolar transistor technology. Combined with the circuits used in the SX-1, MOSFETS prove to be extremely efficient. Unlike bipolar devices, MOSFETS are not subject to thermal runaway damage and are used both in the modulator and PA stages of the SX-1.

Harris SX-1

High technology in a blend of broadcast and computer science

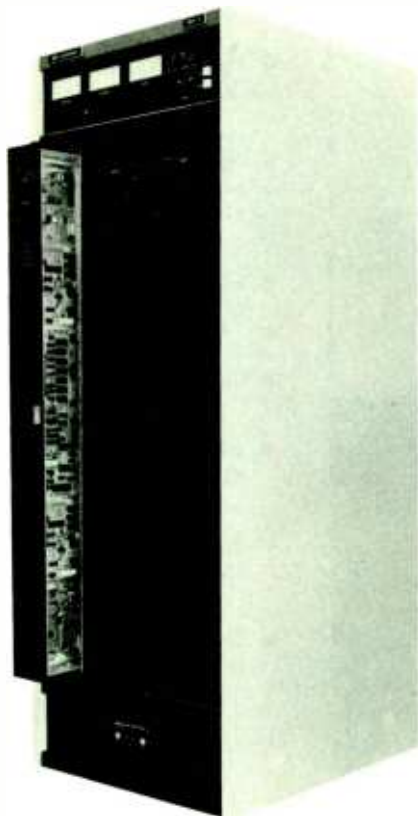

Low level plug-in circuit boards are conveniently housed on a vertical slide-out drawer for easy maintenance.

Additionally, MOSFET transistors lend themselves to parallel operation where multiple devices are required. In the Harris design, the transistors in the power amplifier modules are operated in parallel for DC. But unlike other transmitters, the ferrite combiner places the amplifiers in series, permitting graceful degradation without increasing the stress on the remaining transistors.

HIGHLY EFFICIENT POWER AMPLIFIER

The SX-1 contains one RF power amplifier module conservatively rated to produce 1100 watts output. The MOSFETS are grouped in a quad configuration and combined in a low loss series configured ferrite combiner. Harris' PA module design efforts have resulted in an overall PA efficiency exceeding 90%.

POLYPHASE PDM MODULATION

Polyphase PDM is a significant improvement of the Harris Pulse Duration Modulation system. It is a 4-phase system in which the audio input is sampled four times during each PDM cycle, resulting in lower harmonic and intermodulation distortion.

The combination of the Harris Polyphase PDM Modulation and MOSFET devices achieves a modulator efficiency exceeding 94%. Polyphase PDM also allows the low pass filter to have a wide audio passband, reducing overshoot on sharply rising waveforms. This provides the ability to achieve higher levels of modulation density. Should there be a malfunction of one phase of the system, operation continues at reduced power until a convenient maintenance period can be scheduled. Harris' Polyphase PDM achieves new levels of AM audio performance and reliability.

EXCEPTIONALLY HIGH OVERALL EFFICIENCY

The exceptionally high PA and modulator efficiency of the SX-1 combine to yield greater than 72% overall AC to RF efficiency. This represents a 30% to 45% direct power saving compared with other 1 kW transmitters now in use!

FLAT-PASS OUTPUT NETWORK

After examining various output networks in past and current transmitters, Harris chose an output network/

bandpass filter consistent with the design objectives of the SX-1. The computer designed *Flat-Pass* output network is a Butterworth bandpass filter yielding superb phase and amplitude linearity—two critical requirements for optimum AM Stereo performance.

The innovative design of the *Flat-Pass* network allows modulation monitoring and forward power to be measured at a fixed impedance. The directional coupler is always located at a 50 ohm impedance point. Direct drive tuning and loading controls simply adjust the SX-1 to match a load that can be any value within a 1.5:1 VSWR circle.

High speed lightning protection results from design techniques and devices used in the SX-1. The transmitter constantly monitors VSWR status and takes action only when long-term operational limits are exceeded. Premature VSWR trips, due to station problems or other environmental factors, are eliminated. Should a long-term mismatch condition exist, the transmitter simply reduces output power to a tolerable level, remaining on the air. *The transmitter will not be damaged when operated into an open or shorted load even at full output power!*

DUAL MICROPROCESSOR CONTROL AND STATUS MONITORING

Harris' extensive experience in transmitter technology and digital based products (program automation, automatic camera setup, facility control) permits the incorporation of powerful control and diagnostic features into the SX-1 transmitter. Should a multiple overload occur, the operator may review stored previous meter readings and sequential status indications to determine the fault. A vast number of useful operating parameters is available at fingertip command at the front panel keypad, making the SX-1 one of the easiest transmitters to monitor, control and service. The controller is pre-programmed at the factory and only requires interrogation by the operator.

The transmitter's control and status functions are shared by two microprocessor controller boards working in tandem. Should one unit fail, the other microprocessor automatically picks up the additional duties without interruption. A simple logic probe is included with the SX-1 to as-

Pushbutton diagnostics!

The SX-1 transmitter brings a wealth of diagnostic information to your fingertips through the microprocessor keypad located on the front panel.



sist the operator in checking simple digital circuitry controlled by the microprocessors.

Operationally, the SX-1 consists of three eye-level meters displaying PA Volts, PA Current and Forward/Reflected Power. To the right of these large, easy-to-read meters are six illuminated pushbuttons labeled as follows:

Off-Fault—This pushbutton not only turns the transmitter off, but also acts as a master status light in the event of a transmitter malfunction. Extensive control module LED indicators assist the operator in isolating the fault.

Low, Medium and High—Independent tri power levels can be set to any value for each of the three power control buttons. The illuminated button indicates which power level is operating. No contactor or power transformer tap changes are required.

Raise Power-Lower Power—These pushbuttons allow the operator to set and adjust the power levels. This is a digital power control and has no moving parts.

CUSTOMER INTERFACE PANEL

The Customer Interface Panel provides the user with a centrally located point for all external interface equipment

such as remote control, facility control, audio input, etc. The SX-1 transmitter is designed to interface with the majority of remote control and facility control systems. A momentary closure of 100 milliamps rating (TTL or dry contact) will activate the various control functions. All analog samples (PA volts, PA current, output power, etc.) are buffered.

DESIGNED FOR AM STEREO

The SX-1 is designed for AM Stereo, with special consideration paid to incidental phase modulation, audio input to RF envelope output phase linearity, and RF channel phase response. The standard high stability crystal oscillator and optional frequency synthesizer are both equipped to accept external AM Stereo RF oscillator signals.

MECHANICAL DESIGN CONSIDERATIONS

Service accessibility is a major user benefit of the SX-1. This is accomplished by novel electronic packaging new to broadcast transmitter products. For example, all low level circuit cards such as the RF oscillator, control logic and Polyphase PDM generator cards are located in a pull-out drawer. All critical low level circuit tests can be made while on the air.

The all aluminum cabinet construction reduces shipping cost, while captive hardware and connectorized module interfaces reduce maintenance time.

PROVISION FOR ANCILLARY EQUIPMENT

State-of-the-art technology has reduced component size, allowing the SX-1 to house all the equipment typically found at a 1 kW transmitter site. 36¾ inches of 19-inch rack space is available for ancillary equipment, which may include modulation monitor, audio processing, facilities controls, etc. Segregated low level and power wiring to this equipment is available through the top, bottom and sides.

COOLING SYSTEM

The SX-1 is the first broadcast transmitter incorporating innovative cooling techniques eliminating the need for a blower or fan. The transmitter dissipates only 600 watts of heat. This has allowed Harris to utilize a computer modeled convection cooling technique that offers significant benefits over conventional cooling methods.

The sidewalls of the transmitter form "chimneys" to which the power amplifier modules are attached. Air enters through a filtered rear entrance and rises through the cabinet walls, cooling the power module's heat sinks. The majority of this convection cooling air passes through the isolated chimneys, with only a small amount of air required to flush the inside of the cabinet. Since no blower is required, and the majority of the air does not come in contact with the electronic components, maintenance and noise are greatly reduced.

EASE OF INSTALLATION AND SERVICE

The SX-1 arrives ready for installation. Included is a wall mounted AC disconnect panel designed to interface with the station's electrical distribution system. Installation is as simple as positioning the SX-1 and making final AC, RF and audio connections. No special air handling systems are required.

TODAY'S TRANSMITTER FOR TODAY'S BROADCASTER

Exceptionally high overall efficiency; maximum reliability; improved audio performance; full service microprocessor control and status monitoring; field upgrading to higher powers; *readiness for AM Stereo*—these are just a few of the features in the SX-1 broadcast transmitter. Never before has Harris incorporated as many benefits in today's transmitter for today's broadcaster.

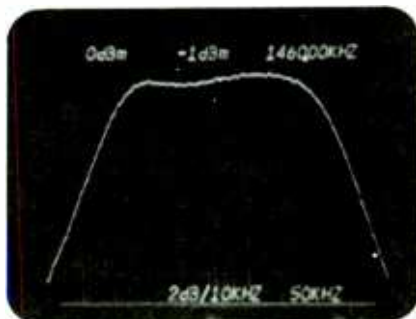

Spectrum analyzer response of Flat-Pass output network maximizes mono and stereo performance.

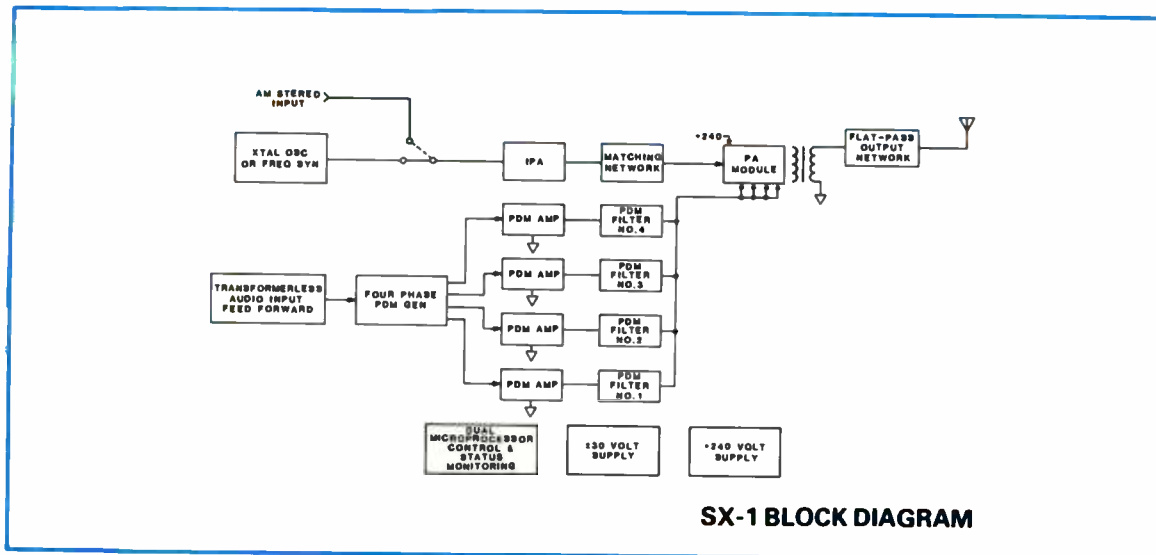

SX-1 SPECIFICATIONS

POWER OUTPUT: (Rated) 1000 watts. (Capable) 1100 watts. Power reduction through 250 watts.

RF FREQUENCY RANGE: 540 KHz through 1700 KHz. Supplied to one frequency as ordered.

CARRIER FREQUENCY STABILITY: A) Crystal Oscillator — ± 20 Hz over temperature range. B) Frequency Synthesizer (optional) — ± 10 Hz over temperature range.

RF OUTPUT IMPEDANCE: 50 ohms unbalanced. Will match into a VSWR of 1.5:1 at carrier.

RF OUTPUT TERMINAL: Female N connector.

CARRIER AMPLITUDE VARIATION: (Carrier Shift): Less than 2% at 100% modulation.

RF HARMONICS: Exceeds FCC and CCIR specifications.

TYPE OF MODULATOR: Patented Polyphase PDM.

AUDIO FREQUENCY RESPONSE: ± 1 dB from 20 to 12,500 Hz.

AUDIO HARMONIC DISTORTION: 1.5% or less at 1 kW, 20 to 12,500 Hz @ 95% modulation. 2.0% or less at 500 watt or lower power operation, 20 to 12,500 Hz @ 95% modulation.

AUDIO INTERMODULATION DISTORTION: 1.0% or less at 1 kW, 60/7000 Hz 1:1, 3.0% or less, 60/7000 Hz 4:1 SMPTE standards at 80% modulation.

SQUAREWAVE OVERSHOOT: Less than 3% at 400 Hz.

SQUAREWAVE TILT: Less than 2% at 400 Hz.

NOISE (UNWEIGHTED): Better than 60 dB below 100% modulation.

POSITIVE PEAK CAPABILITY: 125% positive peak program modulation capability at 1.1 kW.

AM STEREO SPECIFICATIONS: A) Incidental Phase: 0.2 Average (Radians); 0.5 Peak (Radians). B) RF Channel Phase Response (External Input to RF Output): 4%, ± 20 KHz of carrier power. 8%, ± 30 KHz of carrier power.

AUDIO INPUT: -10 to +10 dBm, transformerless 600 ohms balanced, continuously adjustable.

AC VOLTAGE INPUT: 197-251 VAC, 48 to 63 Hz, single phase.

PA EFFICIENCY: Better than 90%.

OVERALL EFFICIENCY: Better than 72%.

POWER CONSUMPTION: 1.4 kW at 0% modulation at 1000 watts. 2.1 kW at 100% tone modulation at 1000 watts carrier. 1.8 kW under average programming conditions.

SPURIOUS OUTPUT: Exceeds FCC and CCIR requirements.

MONITOR PROVISIONS: 10 volts RF (RMS) modulated output sample at 50 ohms (High/Medium/Low) power.

REMOTE CONTROL: Self-contained interface for most remote control or facility control systems.

AMBIENT TEMPERATURE RANGE: -20°C to $+50^{\circ}\text{C}$ (derate upper limit 2°C per 1000 feet altitude).

AMBIENT HUMIDITY RANGE: To 95% non condensing.

AIR FLOW: Free convection.

ALTITUDE: Sea Level to 13,000 feet (4000 meters).

OPERATING ACOUSTICAL NOISE: Better than 45 dBA.

SIZE: 72" H x 28" W x 30" D (1830 mm x 712 mm x 762 mm).

WEIGHT: (Unpacked), 400 lbs. (181 kg) — approximate. Domestic packed, 600 lbs. (275 kg) — approximate. Export packed, 700 lbs. (320 kg) — approximate.

CUBAGE: 68.7 cubic feet (2 cubic meters) packed.

COLORS: Black, white and blue.

TYPE OF ACTIVE COMPONENTS: 100% solid state.

POWER SUPPLY: Self-contained, dry.

SPECIFICATIONS SUBJECT TO CHANGE WITHOUT NOTICE

¹ For AC service connection, please provide 3.0 KVA with a minimum of 5% voltage demand regulation.

NOTE: The above audio performance may be degraded should the transmitter be operated into a bandwidth restricted antenna system.

ORDERING INFORMATION

SX-1 Transmitter, complete with all solid-state devices, crystal oscillator, technical manual.	
Specify frequency994-8581-001 *
SX-1 Transmitter, complete with all solid-state devices, frequency synthesizer, technical manual.	
Specify frequency994-8581-003 *
Recommended spare semiconductor kit990-1012-001
Spare crystal444-XXXX-000
ANCILLARY EQUIPMENT	
AM-90 modulation monitor994-8424-001
AF-80 frequency monitor994-6698-001
Potomac AT-51 test set700-0499-000
MSP-90 tri band AGC amplifier994-8357-001
MSP-90 AM limiter994-8200-001

* Contact Harris for special ordering information and details on the optional power upgradable SX-1.



HARRIS

**MEDIUM WAVE
ANTENNA
PHASING
EQUIPMENT
AND ACCESSORIES**

- Network design experience and capability that are recognized and accepted throughout the industry
- Highest construction standards in the industry
- Highest quality long-life components with conservative ratings to maximize reliability
- Wide network adjustment range for easy tune-up
- Modern control circuitry provides full transmitter and RF contactor protection, direct remote control interface
- Highest quality design and construction at affordable prices



HARRIS' CUSTOMIZED MEDIUM WAVE PHASING AND

Harris phasors and medium wave antenna networks are custom built to the highest standards in the industry. Our network design experience is well known throughout the broadcast community. From 250 watts to 200 kilowatts, Harris phasors and medium wave antenna networks are in use around the world. Superior design and construction techniques, and the use of quality components are providing customers years of stable and reliable performance.

The key to our phasor capability is our highly experienced antenna design engineering staff, which is available to tailor networks for your specific requirements. Recognized as experts in the medium wave antenna field, Harris engineers' field experience gives them the perspective to understand the problems associated with installation and adjustment of medium wave antenna networks.

Innovative network designs for special requirements such as distortion reduction and broadband compensation can be provided. Computer design techniques aid in providing an optimum component configuration for your station. Experienced technicians assemble and test each phasor and antenna unit to assure a quality product. Many of the design and construction practices are unique to Harris and are not found in competitive units.

A modern control circuit is used with every phasor equipped with multiple antenna mode operation. A simple, straightforward 24-volt DC relay logic circuit is housed on one printed circuit board. Clean printed circuit board construction eliminates problems normally associated with hand wired control logic panels, thus improving reliability.

All relays, components, and terminal strips on the control logic board are permanently labeled for quick and easy reference.

This modern control circuit includes features not found in many competitive phasor designs. For example, a time delay is provided for RF to be completely removed before contactor switching - thus avoiding burned contacts. An automatic high voltage restart command is given to the transmitter after pattern switch. This eliminates a manual operator step and reduces annoying "off the air" pattern switch time to one second. Remote control commands are momentary, low current contact closures enabling direct connection to most remote control and ATS systems. Remote mode status indication is also provided for station use.

These Harris control circuit features will extend component life, minimize listener annoyance, and eliminate remote control and transmitter interface equipment. This means direct savings to your station.

COMPARE THESE CONSTRUCTION FEATURES

- Easily operated cyclometers with counter dials are used on front panel controlled components. Positive stop action is provided on these controls.
- Cabinet interconnections are mechanically solid and electrically continuous to provide a well integrated system. Phasor cabinet side plates are made of aluminum, and separate cabinet assemblies are connected with copper strap.

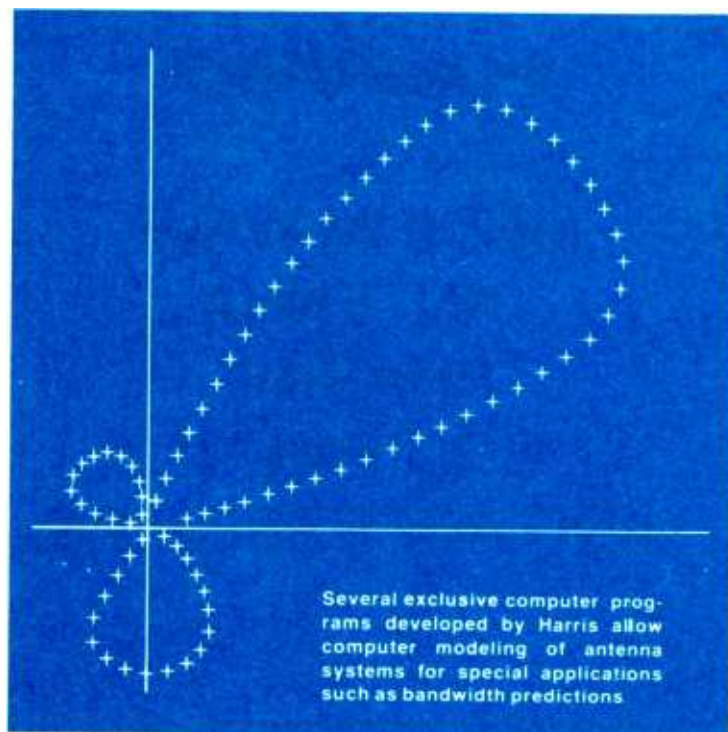

- All tubing coils are connected to other components with tubing the same size as that used in the coil. Parallel tapping straps with a minimum of excess length are used. These features minimize the risk of arcing or overheating.
- Permanent stencilling is used to identify components and no stick on labels are placed across capacitor insulation.
- The phasor cabinets can be matched to the styling of your Harris transmitter. Optional front and rear doors and hinged meter panels are available. All cabinet doors are equipped with interlocks to remove power from the equipment when the doors are opened. All phasor components are removable from inside the cabinet, facilitating quick servicing. Thus, cabinets may be mounted flush against a sidewall to conserve space.
- Test jacks are provided at all phasor input and output ports and ACU input locations. Thermocouple ammeter switches are make-before-break with a compensating loop and are double throw to completely remove the meter from the circuit. Toroidal ammeters are also available. Other switches are available with provision to accept plug-in meters and to provide "cold" attachment points for operating bridge measurements without loss of air time.
- All insulators are chosen to provide at least one inch per 5 kV separation to ground. All coils are spaced at least one coil radius from walls to minimize induced wall currents. Insulator material is selected on the basis of dielectric strength and dissipation factor, so that RF voltage gradients will not overstress the material.
- Harris maintains a 24-hour Service Department to assist you with your emergency parts requirements.

Harris phasor engineers are eager to work with station personnel and consulting engineers to provide a quality antenna system. For more information, contact your Harris sales representative or call the Radio Sales Department at our home office in Quincy, Illinois (217-222-8200).

ANTENNA NETWORKS...SUPERIOR DESIGN TECHNIQUES

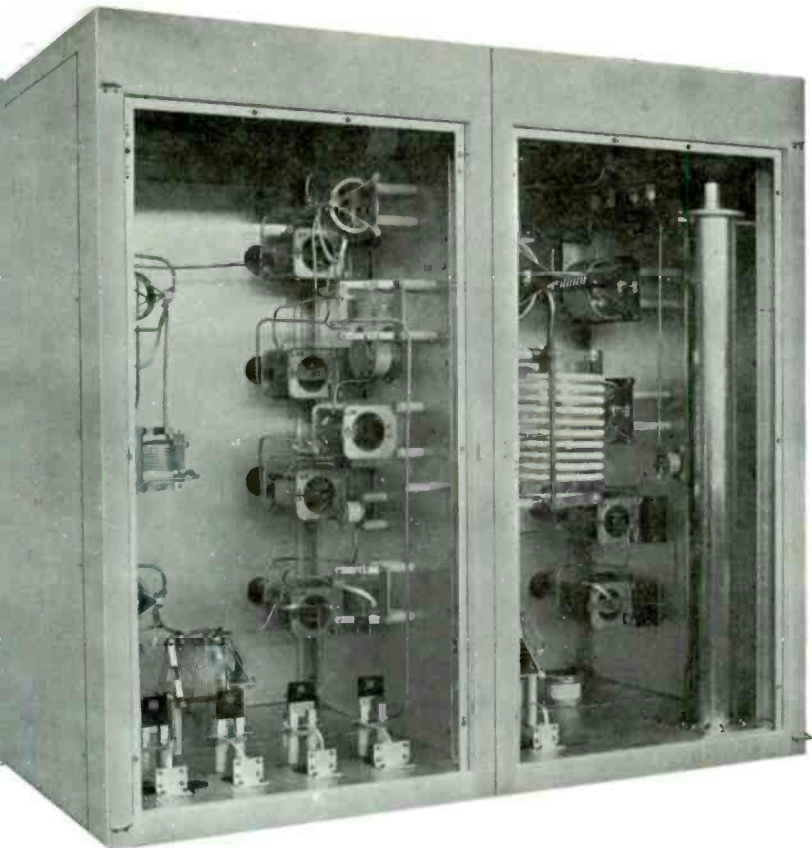

A close look at Harris' phasor construction reveals many important features that add not only to the reliability, but to the convenience of setup and maintenance.

Harris has been manufacturing custom medium wave antenna networks for over 25 years. This experience and outstanding craftsmanship guarantees many years of reliable service.

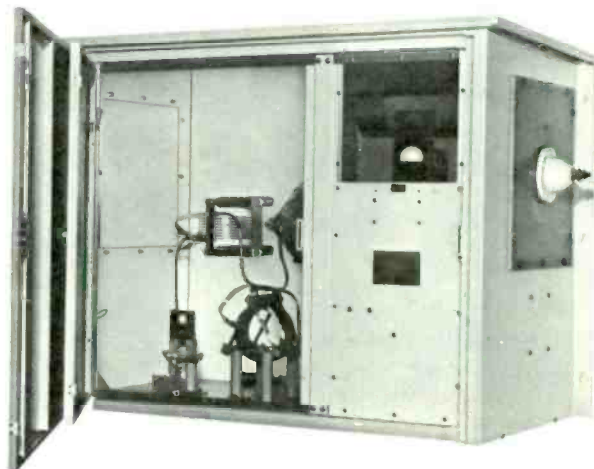

Antenna Coupling Unit networks can be housed in rugged all aluminum weatherproof enclosures as shown, or on flat aluminum panels for mounting in existing tower buildings.



The optional custom phasor cabinet shown here includes hinged front panels for common point meter access.

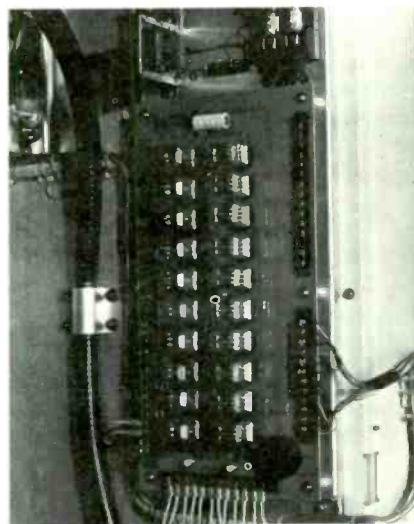

A simple, yet modern control logic board provides several key features for stations with multiple antenna modes.

AM ANTENNA COUPLERS AND ACCESSORIES

WEATHERPROOF 5-10 KW ANTENNA COUPLING UNITS

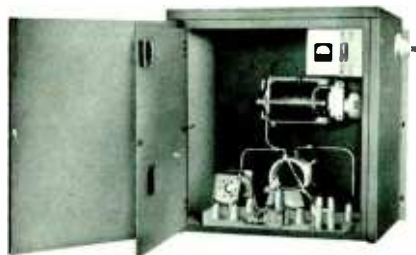

Housed in aluminum cabinet with double front doors. Large coils combined with capacitors of generous voltage and current ratings to assure a lifetime of service under extreme heat or cold. A large antenna lead in bowl is provided. Mounting is with metal flanges on the back of the tuning unit for attachment to wooden poles set in ground or for mounting on wall.

SPECIFICATIONS

CARRIER POWER: 5,000 watts or 10,000 watts AM, as ordered.

FREQUENCY: 525-1,700 kHz as ordered.

LINE IMPEDANCE: 50 ohms

TO MATCH: Series fed tower of from 70° to 100° electrical length.

CIRCUIT: Full Tee Network.

WEIGHT: Approximately 200 lbs.

SIZE: 38" high, 37" wide, 21½" deep.

ORDERING INFORMATION

Antenna Coupling Unit, 5 kW994-5309-001

Antenna Coupling Unit, 10 kW ...994-5309-002

NOTE: When ordering, state carrier frequency, transmission line impedance, power, tower height and tower measurements, if known. Couplers to match unusual loads such as short or tall towers, shunt feed, etc., are available on special order, at extra cost.

RF ANTENNA METERS

Internal thermocouple standard scale. Weston Model 308, three-inch square case. Other ranges not listed below are available with many carried in stock. Also expanded scale meters in inventory.

ORDERING INFORMATION

Meter, 0-3 R.F. amperes634-0206-000

Meter, 0-6 R.F. amperes634-0238-000

Meter, 0-8 R.F. amperes634-0209-000

Meter, 0-10 R.F. amperes634-0210-000

TEST JACKS



Harris manufactures both a medium power and high power RF test jack for use in several medium wave antenna network applications. The medium power test jack (shown at left) is rated for 35 amperes while the high power version (shown at right) is rated for 100 amperes. These units are constructed to assure maintenance free operation.

ORDERING INFORMATION

Medium Power Test Jack994-3280-002

High Power Test Jack994-3280-003

WEATHERPROOF SERIES—FED ANTENNA COUPLER, 1250 WATTS



Recommended for broadcast transmitter powers of 1,000, 500 and 250 watts, 100% modulated. Heavy edgewound coil has generous inductance for a Tee network along with fixed mica capacitors supplied. Extra room is provided to install either diode or thermocouple remote metering equipment. Heavy duty meter shorting switch eliminates antenna meter from the circuit when not in use for lightning protection. Meter is observed through plexiglass porthole. Front door of cabinet has been removed for illustrative purposes.

SPECIFICATIONS

CARRIER POWER: Up to 1250 watts AM.

FREQUENCY: 525-1700 kHz as ordered.

LINE IMPEDANCE: 50 ohms.

TO MATCH: Series-fed tower of from 70° to 100° electrical length.

CIRCUIT: Full Tee Network.

WEIGHT: 98 lbs.

SIZE: 20" high, 20¼" wide, 18¾" deep.

ORDERING INFORMATION

Antenna Coupler with antenna meter994-3494-001

NOTE: When ordering, state transmission line impedance, frequency, tower height, and tower measurements, if known. Couplers to match unusual loads such as short or tall towers, shunt feed, etc., are available on special order at extra cost.

METER SHORTING SWITCH



A heavy duty, make-before-break meter shorting switch of the plunger or push type. Heavy bronze tempered spring grips on both sides assure accuracy and durability.

ORDERING INFORMATION

Meter Shorting Switch, rating 15 amperes994-3493-001

Meter Shorting Switch, rating 40 amperes (shown above)994-6527-001

ADDITIONAL MEDIUM WAVE ANTENNA ACCESSORIES

TOWER LIGHT ISOLATION CHOKES

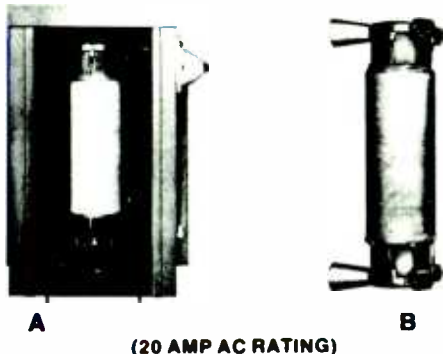

(20 AMP AC RATING)

Most popular of all tower light isolation chokes. Available in 2 or 3 wire models and in open type, or weatherproof as illustrated. Wound on heavy triple X tubing with mica-by-pass condensers on each circuit end. Inductance approximately 350 uH. 3" stand-off insulators are part of coil. (Weatherproof type), 24" high, 17 3/4" wide, 10 1/4" deep. Illustration on left shows weatherproof unit with front cover removed.

ORDERING INFORMATION

Tower Choke, 2 wire, weatherproof,
Fig. A994-3937-001
Tower Choke, 3 wire, weatherproof,
Fig. A994-3938-001
Tower Choke, 2 wire, open type,
Fig. B994-3935-001
Tower Choke, 3 wire, open type,
Fig. B994-3936-001

FEED-THRU BOWLS



FEED-THRU BOWL ASSEMBLY

A large feed-thru bowl with 50 kW modulated rating. Available in single and double units and with solid or hollow studs as listed below. Bowls are Alsimag. Hardware, heavy brass. Velutex seals are provided for weather-tight installation.

ORDERING INFORMATION

Solid stud, 2 bowls, for walls
to 10 1/2" thick994-2870-001
Same as above but hollow stud . .994-3254-001
Solid stud, single bowl, for
walls 1" thick994-5280-001
Same as above but hollow stud . .994-5281-001

RF CONTACTORS

Harris offers a complete line of RF contactors of both the mechanical and vacuum variety.

The popular mechanical contactors, that handle a wide range of medium wave antenna applications, are available from stock.

DIODE TYPE REMOTE METER EQUIPMENT



For remote indication of RF current. Consists of a carefully constructed pickup loop attached through a short coaxial cable to a solid-state rectifier assembly. RF current is measured without breaking the main lead. No AC power is required. May be used with any good 1 MA DC meter. Power range: 250 watts to 50,000 watts. Frequency range: 540 kHz to 1600 MHz.

ORDERING INFORMATION

Diode remote meter unit,
less meter994-6112-001
0-1 MA METERS
Meter 3" sq. case,
scale 0-3 R.F. amperes632-0418-000
Meter 3" sq. case,
scale 0-6 R.F. amperes632-0405-000
Meter 3" sq. case,
scale 0-8 R.F. amperes632-0420-000
Meter 3" sq. case,
scale 0-10 R.F. amperes632-0421-000
Meter 4" sq. case,
scale 0-3 R.F. amperes632-0424-000
Meter 4" sq. case,
scale 0-8 R.F. amperes632-0426-000
Meter 4" sq. case,
scale 0-10 R.F. amperes632-0361-000
Meter 4" sq. case,
scale 0-15 R.F. amperes632-0428-000
NOTE: Other meter scale ranges available at extra cost. Above for use with diode remote unit, not thermocouple.

HEAVY DUTY SAMPLING LOOP



This is a very rugged fixed non-shielded RF sampling loop. It is heavily galvanized after welding, and is fitted with large steatite insulators and heavy duty tower leg clamps for easy and positive mounting. Complete with type female "N" jack. For 50 to 70 ohm sampling line.

ORDERING INFORMATION

Heavy duty sampling loop994-6126-001

ISOLATION COILS

Harris manufactures several types of sampling loop isolation coils to meet the needs of the directional array and associated monitoring system.

Standard units available use either 1/2 inch or 3/8 inch phase stabilized foam transmission line. The isolation coils are available with an optional resonating capacitor. The unit can be mounted on a flat aluminum wall panel or housed in a weatherproof enclosure.

OPEN WIRE TRANSMISSION LINE ACCESSORIES



**Transmission
Line Bracket**



Line End Plate



Horn Gap



**Center Post
Assembly**

TRANSMISSION LINE BRACKET. For 5 or 6 wire transmission line. Rating up to 150 kW modulated. Made of ¼" steel 3" wide with welded L section on each side to fully prevent twisting under ice or wind load. Supplied with 8¼" ribbed insulator, wire guides and all hardware. Galvanized throughout.

Line Bracket994-3327-001

LINE END PLATE. To terminate the open wire line at each end. Plate is ¼" thick, 20" square. Fully galvanized. Includes turn-buckles, 25½" strain insulator and all hardware. Rating up to 150 kW modulated.

End Plate994-3328-001

HORN GAP. A very desirable item where higher power is employed. Connects to hot side of line and ground to drain off lightning and heavy static discharges. Usually one is employed for each 200 feet of line. Insulator for 150 kW. Arc gaps heavy chrome plate. Galvanized throughout.

Horn Gap994-3322-001

CENTER POST ASSEMBLY. Has variety of uses such as end or corner angling of transmission line, support insulator for two wire line or rhombic antennas, and a guide insulator such as end of building or coupling unit. Rating 150 kW. Galvanized throughout.

Center Post Insulator994-3864-001

MODEL OIB-1 Operating Impedance Bridge



The Delta Model OIB-1 Operating Impedance Bridge measures the operating impedance of the individual radiators, networks, transmission line sections and common point of directional antennas while they are functioning under normal power. The OIB-1 has a frequency range of 500 kHz to 5 MHz, with a power rating up to 10 kW. Several optional accessories are available for the OIB-1.

Basic OIB-1700-0063-000

MODELS CPB-1/CPB-1A Common Point Impedance Bridges



The Delta Models CPB-1 or CPB-1A Common Point Impedance Bridges can be custom installed in your Harris phasor or sold separately. The CPB-1 will handle common point powers up to 5 kW with 100% modulation on a continuous basis, while the CPB-1A is designed for 50 kW operation. Both instruments have two 4-inch dials calibrated directly in resistance and reactance. A front panel meter provides a null condition.

CPB-1700-0055-000

CPB-1A700-0056-000

MODELS TCA/TCA-XM RF Ammeter Systems



The Delta Models TCA and TCA-XM are radio frequency current measuring instruments designed for broadcast antenna systems. These instruments are intended for applications where conventional thermocouples have been used in the past. The units meet the FCC's requirement of 2% accuracy and are calibrated at RF frequencies to insure application accuracy. These units can be incorporated into your custom Harris antenna network or sold separately. Contact us for the various models and configurations available.

Specifications subject to change without notice.



HARRIS

AM-90

Medium Wave Modulation Monitor

- Exclusive self-scan neon bar graph display
- Exclusive RMS sideband power
- Exclusive modulation metering with no overshoot
- Digitally programmable selectable peak flasher
- All electronic indicators - no panel meters
- Internal AGC maintains accuracy even with carrier drift
- Built-in carrier and modulation alarm units
- Self-calibration feature

The new Harris AM-90 Modulation Monitor is designed for continuous monitoring of the amplitude modulation envelope in the 450 KHz to 30 MHz frequency range. This sensitive instrument assures strict compliance with FCC rules and regulations. The AM-90 Modulation Monitor is an all solid-state self-contained rack mounted unit consisting of compact mainframe and two printed circuit cards. All controls are front panel mounted. Connections to a remote unit, primary power and RF inputs are mounted on the rear of the chassis.

NEON BAR GRAPH DISPLAY

A first in innovative technology is represented by the AM-90's highly accurate neon bar display for measuring carrier and modulation levels. The flat panel indicator displays two separate bar graphs, each containing 201 elements for 1/2% resolution. Display segments are printed on 0.002-inch center spacing. At normal viewing distances, the glow blends into a continuous, precisely controlled bar length. This unique analog display with no moving parts offers distinct advantages over previous designs incorporating electromechanical meters. Now the station operator has a choice of meter ballistics, including FCC specified or peak reading. An additional metering function can be selected which gives the RMS value of the absolute value of modulation. A rotary meter amplifier switch provides up to 50 dB of gain to the bar graph display. This switch, with amplification selectable in 10 dB increments, enables the operator to measure low amplitude modulation or transmitter signal-to-noise ratio with a built-in 20 Hz to 20 KHz noise filter.

FLASHERS

Two fixed flashers are factory adjusted to +125% & -100% modulation, allowing constant monitoring of modulation levels. These indicators are triggered whenever the monitored RF signal modulation exceeds the preset value. A separate digitally programmable flasher offers

positive or negative polarity selection with a usable range of 1% modulation to +200% or -100% modulation. Flasher accuracy is $\pm 1\%$ at 1 KHz.

CARRIER AND MODULATION ALARMS

Carrier and modulation alarms illuminate when carrier amplitude drops below 50% of the preset level, or when modulation remains under 10% for 10 seconds.

GENERAL

No tuning is required at the monitor. The AM-90 Modulation Monitor incorporates an expanded scale carrier level meter for accurate carrier level deviation measurements. The wideband linear phase filter design is capable of passing 20 Hz to 20 KHz with no measurable overshoot from square wave modulation. The AM-90 features three separate high fidelity audio outputs: 1) electronically balanced, +10 dBm (into 600 ohms); 2) 5-volt RMS instrumentation output (into 10k ohms); 3) auxiliary audio output amplified through the metering circuit. The AM-90 Modulation Monitor incorporates high RF input impedance to facilitate connection of other instruments to the same RF source. A mode indicator provides non-FCC prescribed meter operation (RMS or peak modulation). An optional remote meter panel duplicates most of these functions for measurements at distant locations.

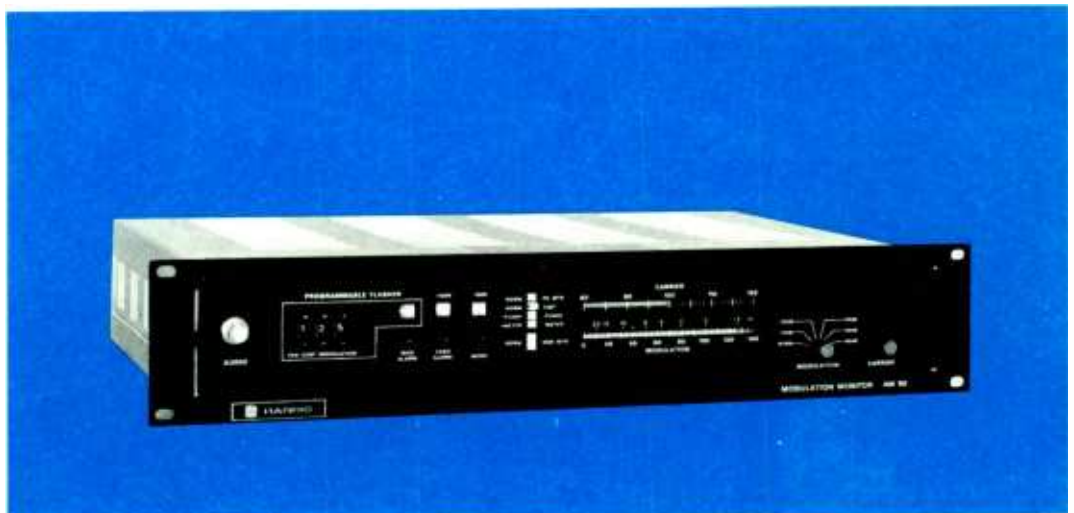

SPECIFICATIONS

FREQUENCY RANGE: 450 KHz to 30 MHz

RF INPUT: 1.0 Vrms to 10.0 Vrms

POWER INPUT: 115 Vac \pm 15%, 50-60 Hz (230 Vac \pm 15% available)

MODULATION INDICATION

DISPLAY METER: 0% to 100% on negative peaks.
0% to 140% on positive peaks.

FLASHER FREQUENCY RESPONSE: +0%, -5%; 20 Hz to 20 KHz

FLASHER ACCURACY: \pm 1% at 1 KHz

AUDIO TEST OUTPUTS

FREQUENCY RESPONSE: +0 dB, -0.5 dB; 20 Hz to 20 KHz

DISTORTION: 0.15% maximum at 99% modulation, 1 KHz audio, 450 KHz to 1.8 MHz carrier; 0.50% maximum, 1.8 MHz to 30 MHz carrier

SIGNAL-TO-NOISE: 75 dB minimum referenced to 100% sine wave modulation

ELECTRONICALLY BALANCED OUTPUT

OUTPUT IMPEDANCE: 75 ohms balanced

OUTPUT LEVEL: +10 dBm into 600 ohms at 100% sine wave modulation

INSTRUMENT OUTPUT

OUTPUT IMPEDANCE: 100 ohms (unbalanced)

OUTPUT LEVEL: 5 volts RMS into 10k ohms at 100% sine wave modulation

MODULATION CALIBRATION: Built-in calibration, digitally synthesized RF source, +125% and -100% modulation, RMS value 111% \pm 0.1%

REMOTE OUTPUT: For meter and flasher indications at another location, use Harris' remote meter panel 994-8487-001

GENERAL

SIZE: 19" long x 3.5" high x 13.5" deep (48 cm x 9 cm x 34 cm). Mounts in standard relay rack

WEIGHT: 15 pounds (6.82 kg). Export Packed: apx. 20 pounds (9 kg)

AMBIENT TEMPERATURE RANGE: -20°C to +55°C (-4°F to 131°F)

HUMIDITY: 95% maximum (non-condensing)

ALTITUDE: 10,000 feet maximum (3048 meters)

SPECIFICATIONS SUBJECT TO CHANGE WITHOUT NOTICE.

ORDERING INFORMATION

AM-90 Solid-State AM Modulation Monitor 994-8424-001
AM-90 Remote Meter Panel 994-8487-001



AF-80 Medium Wave Frequency Monitor

Harris' medium wave frequency monitor is an FCC type accepted instrument designed to meet or exceed all requirements for measuring carrier frequencies of standard AM broadcast transmitters.

Available in a digital read-out model, this frequency monitor employs solid-state integrated circuits throughout, and features digital read-out.

The monitor will accept as input any standard AM frequency, and will indicate the deviation from assigned frequency. The input may be a modulated RF signal of 0.2 volts to 10 volts RMS. Unlike other designs, there is no loss of indication when the sample RF is modulated above 95%. A unique circuit "remembers" the last valid measurement until the modulation of the RF input is less than 95% for a normal one-second counting period.

A two-digit display indicates the magnitude of the frequency error, and a plus-minus indicator shows if the frequency is above or below the assigned frequency. Above ± 31 Hz error, the digits are blanked, but the sign indicator continues to operate.

An "alarm" indicator and relay contact closures warn of frequency errors greater than ± 20 Hz.

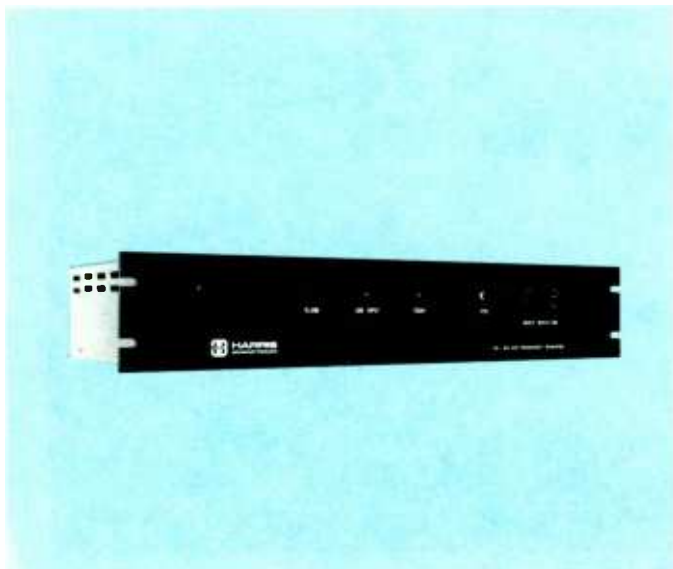

After A.C. power is applied the monitor stabilizes to reliable readings within 5 minutes. There are no delicate thermostats or heater controls. The reference oscillator is heated by a proportional oven which maintains the unit's accuracy at a constant level over a wide range of ambient temperatures.

Only one crystal is needed to cover the entire broadcast band. Setting up to the station frequency simply entails "programming" the counter. The procedure is so simple that it can easily be accomplished in the field should the station change frequencies.

A test button, when depressed, checks all LED's and read-out tubes.

A remote indicator may be operated over telephone lines of up to 5000 ohms loop resistance. The optional remote accessory may be factory installed or added later in the field. In either case the remote panel contains an analog meter display. One control adjusts calibration of the remote meter, and the test button confirms that the meter is polarized correctly.

SPECIFICATIONS

FREQUENCY RANGE: 540-1600 kHz as ordered.

RF INPUT IMPEDANCE: 50 ohms.

RF INPUT CONNECTOR: BNC.

RF INPUT SENSITIVITY: (Unmodulated) 10 mV to 10 V RMS carrier.
(Modulated) 0.2 V to 10 V RMS RF, 0-95% modulation.

A.C. POWER INPUT: 115/230 VAC, 50/60 Hz, 40 watts.

REFERENCE OSCILLATOR: Crystal-controlled in proportional oven.

ACCURACY: Better than 1.85 ppm (0.5 Hz @ 540 kHz).

DEVIATION INDICATOR RANGE: ± 31 Hz deviation.

STATUS INDICATORS (LED): Low input alarm; ± 20 Hz deviation alarm; Count period.

ALARM RELAY: 120VAC/28 VDC @ 5A N/O & N/C contacts of ± 20 Hz or greater deviation.

REMOTE: Maximum remote loop resistance...5000 ohms.

AMBIENT TEMPERATURE RANGE: 0 to 55°C.

AMBIENT HUMIDITY RANGE: 0 to 95% relative humidity.

ALTITUDE: 0 to 7500 feet above sea level.

DIMENSIONS: 19" wide, 3.5" high, 10.25" deep.

WEIGHT: (Domestic packed) 20 lbs. (Export packed) 45 lbs. (Cube) 2.4 cu. ft.

ORDERING INFORMATION

AF-80 medium wave frequency monitor, digital read-out . 994-6698-001

Recommended spare IC's for AF-80 frequency monitor . . 990-0747-001

Remote (digital) meter panel for AF-80 frequency monitor
above 994-6863-001

SPECIFICATIONS SUBJECT TO CHANGE WITHOUT NOTICE.



HARRIS

30 Amp RF CONTACTOR

- **No adjustments required**
- **Expected life under normal use 30 years**
- **1/16 the power requirement of conventional contactors**
- **Reliable operation under wide temperature range**
- **Smooth, quiet motor-driven operation**

The Harris 30 Amp RF Contactor is unlike any other product on the market today. Beautifully simple in design, it achieves a high degree of reliability through smooth operation, for trouble-free use in phasors, antennas, transmitter dummy load switching, or any similar RF switching application.

Unique Design Concept

Earlier model switches operate by the violent action of a solenoid, which accelerates the fatigue of the device. With Harris' revolutionary contactor, transfer is accomplished through smooth conversion of rotary to linear motion. Rotary motion is supplied by a small, but very powerful AC motor through a high reduction gear box, and transferred to linear motion by a simple cam. A remarkable life expectancy is achieved through avoidance of the high impact method of operation. The result: none of the moving parts requires any maintenance.

Rugged Performer

The Harris RF Contactor will handle conservatively 30 amperes of RF current in the medium wave broadcast band. High voltage insulation properties allow operation as high as 30 kV peak (60 Hz test). And the Harris RF Contactor won't buckle under adverse temperature conditions. Smooth operation has been demonstrated to -30°F ; acceptable performance down to -50°F is attainable.

Efficient Operation

Cycling time is extremely fast (less than 0.5-second). What's more, power consumption is considerably less than that of older solenoid contactors, resulting in less of a voltage drop over long control lines.

No Adjustments Necessary

Every unit is qualified through individual testing to insure the highest level of quality control. Precision manufacturing of all component parts assures optimum performance with absolutely no adjustments.

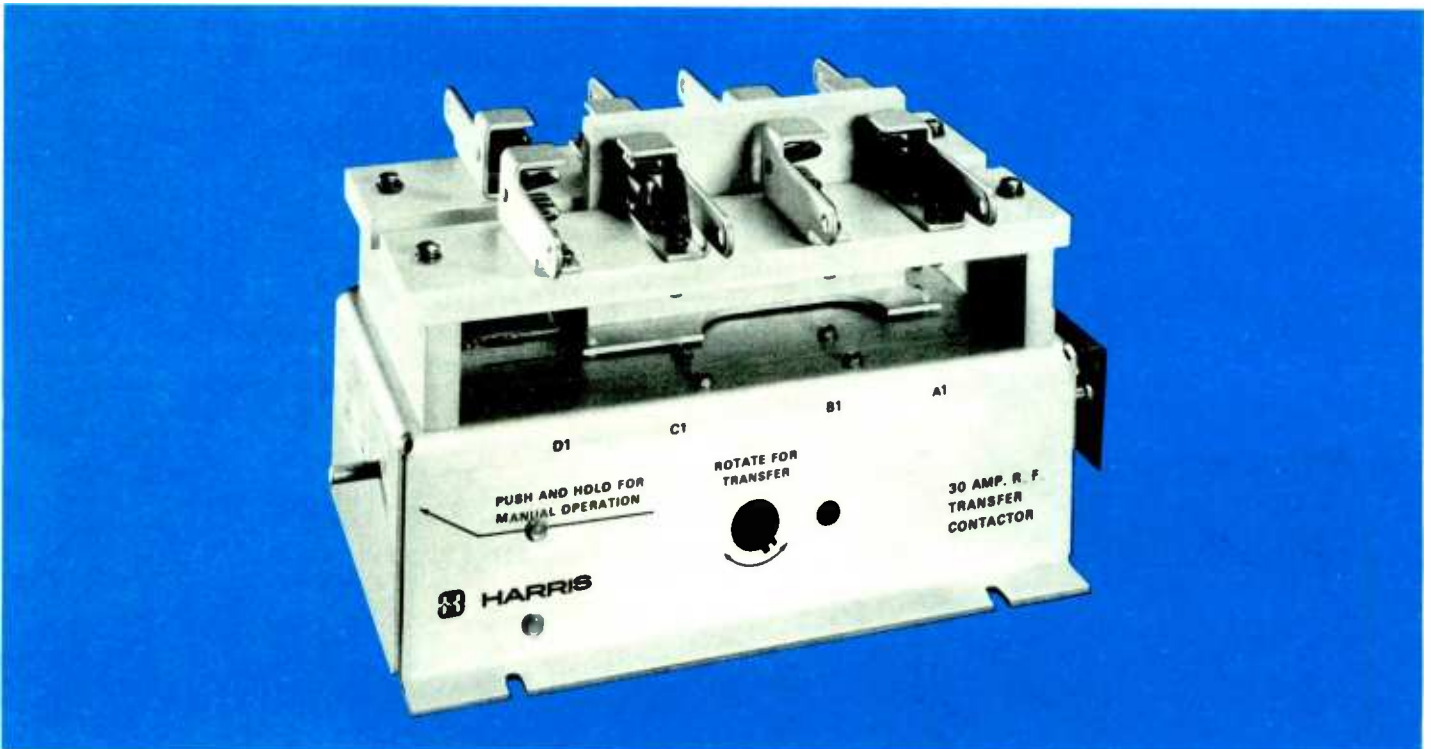

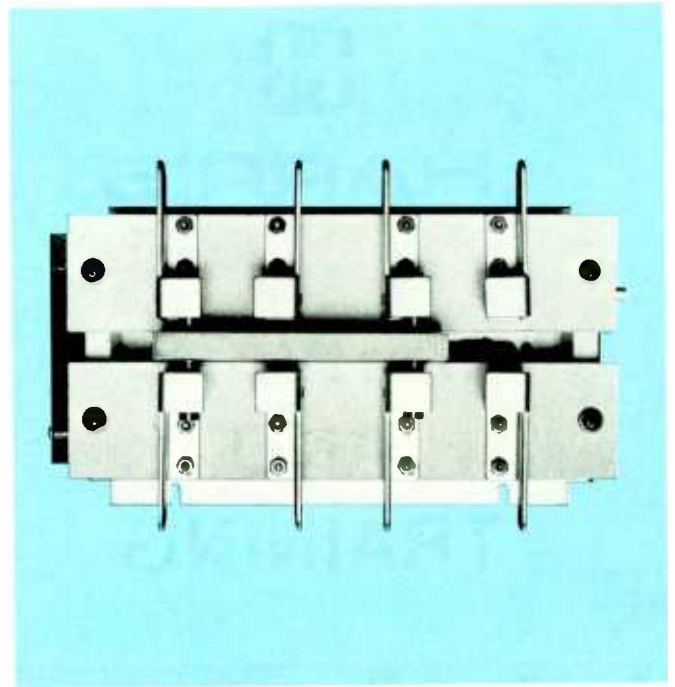
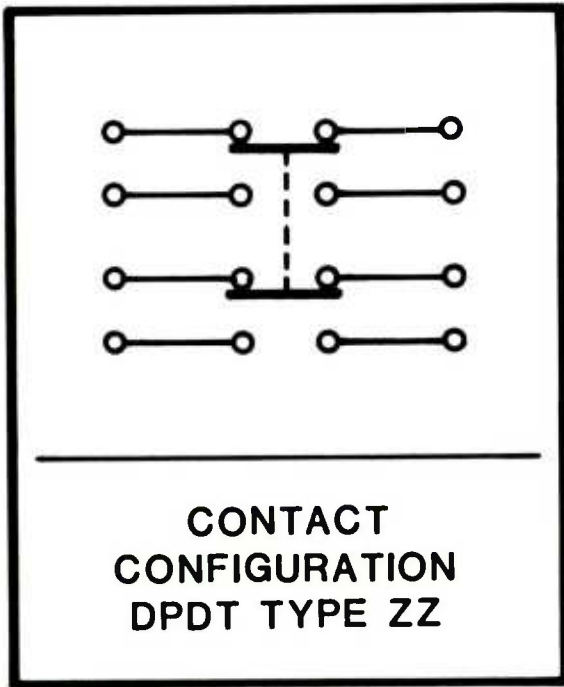

30 AMP RF CONTACTOR SPECIFICATIONS

FREQUENCY RANGE: 540 kHz to 1700 kHz.

RF CURRENT CAPABILITY: 30 amperes.

RF TEST VOLTAGE: 30 kV peak (60 Hz test voltage)
-any contact to chassis. 22 kV peak, 60 Hz between any two contacts.

POWER REQUIREMENTS: 208/230 VAC, 50-60 Hz at one ampere.

AMBIENT OPERATING RANGE: -30°F to 130°F.

STATUS INDICATORS: Switching provided for external indicators.

TRANSFER TIME: less than 0.5 seconds.

OPERATING MODE: RF contacts form ZZ, DPDT.

MAIN FRAME: heavy aluminum enclosure.

INSULATING MATERIAL: special high voltage polyester glass fiber.

CONTACTS: high quality tempered beryllium copper.

DIMENSIONS: Height - 7.0 inches (18 cm).
Length - 12.0 inches (31 cm).
Width - 7.0 inches (18 cm).

WEIGHT: 7.0 pounds (3.18 kg).

SPECIFICATIONS SUBJECT TO CHANGE WITHOUT NOTICE

ORDERING INFORMATION

Harris 30 Amp RF Contactor994-8524-001



HARRIS

SERVICE AND TRAINING



Harris' dedication to producing highest quality, state-of-the-art broadcast products is rivaled only by its commitment to offer complete customer service, both on a routine basis and in emergencies. Striving to eliminate the expense and inconvenience of equipment repairs and down time, Harris has assembled a dedicated team of qualified personnel to staff its non-stop, three-fold service department consisting of Field Services, Parts Department, and Customer Training.

FIELD SERVICE DEPARTMENT. Although technical service availability represents a value not always totally appreciated, Harris' 24 hours, 7 days a week Emergency Field Service has been many customer's salvation through the years. By dialing (217) 222-8200 and asking for the FIELD SERVICE DEPARTMENT you will be put in contact with a representative who has been specially trained in the product information

relevant to your particular service need. Over the telephone our Field Service engineer will listen to your difficulties and walk you through the proper trouble-shooting steps in order to isolate the problem. Once the difficulties are located, the representative will contact the Parts Department to order the necessary parts while you are still on the phone—thus assuring that the order has been placed and will be shipped on the next available transportation.

If the equipment difficulty you are experiencing has left you off-air or in an emergency condition, dial the 222-8200 number and state plainly that you are experiencing an EMERGENCY. The word EMERGENCY will immediately enter your problem and parts requirement upon the Emergency Service Board—a billboard type system designed by the Harris Service Department to provide priority service to emergency customers. Once you are listed on "the Board" service department personnel go directly to work tracking the needed parts and supplies; the job is not considered completed until the equipment is in your hands and you have confirmed its arrival.

While every effort is made to handle emergencies over the phone and eliminate costly customer expenses, a team of Field Service Engineers in Quincy and others strategically located across the country are available to make station visits and are qualified and equipped to handle emergencies in the field promptly and accurately.

PARTS DEPARTMENT. Although the Harris Parts Department works closely with Field Service, it is also capable of direct customer interaction. If you are knowledgeable of your equipment problems and wish to order a repair part, call the (217) 222-8200 number and request the PARTS DEPARTMENT. One of our Parts Department personnel will take your order and immediately confirm the parts availability from our inventory. A large parts inventory coupled with a main warehouse inventory makes it possible for Harris to offer you same day shipment of your order for over 90% of all requests.

TECHNICAL TRAINING. Because the technology of broadcast equipment is advancing at an increasingly rapid rate, many station personnel are seeking ways to stay abreast with these changes. Knowledge acquired even a few years ago may not be sufficient now to ensure proper operation and maintenance of current equipment. Consequently, participation in a program of continuous technical updating is a high priority objective of many Broadcast technical staffs. Such participation can help considerably in maximizing equipment performance and reliability.

Several sources of update training are available and one of the most productive is the Harris broadcast technical education program conducted in Quincy, Illinois. Here instructors with years of formal teaching experience coupled with vast broadcast electronics knowledge conduct courses on all major equipment manufactured by the Harris Broadcast Division. Harris also delivers an A.A.S. degree Broadcast Electronics Technology Program.

In order to maximize the benefits of these courses, circuit analysis presentations are made with an emphasis on understanding state-of-the-art component and system applications in present day equipment. Thorough conceptual sessions are conducted during the applicable seminar on such Harris features as Pulse Duration Modulation (PDM); Progressive Series Modulation (PSM); Intermediate Frequency (IF) Modulation; Digitally Synthesized Modulation (DSM); etc. As a preventative measure, a portion of each seminar addresses specific maintenance and troubleshooting techniques.

For more information on the types of training courses offered, the cost, and time and place of each seminar, call (217) 222-8200 and request the BROADCAST TECHNOLOGY LEARNING CENTER.



HARRIS

SW-100A

**100,000 Watt
Short Wave
Broadcast
Transmitter**

- High level Pulse Duration Modulation for exceptional audio performance.
- Overall efficiency exceeds 55% - for reduced operating costs.
- Only three tube types used - reduces spare stocking costs.
- Pre-set channel tuning in 20 seconds or less - minimizes programming disruption.
- Vapor phase cooling provides constant anode temperature resulting in extended tube life.
- Front and rear cabinet accessibility eases maintenance.



Harris' SW-100A is a high-level, plate modulated short wave broadcast transmitter, featuring automatic 10-channel pre-set tuning. Utilizing the exclusive Pulse Duration Modulator, the SW-100A provides higher efficiency, lower operating costs and overall performance superior to that of any other short wave transmitter in the 100 kilowatt power range. The transmitter is capable of operating at any frequency between 3.2 and 22 MHz.

HIGH EFFICIENCY.....EXCEEDS 55%. The Pulse Duration Modulator employed in the SW-100A is almost 90% efficient (instead of the usual 50% to 60%), enabling the transmitter to achieve an unusually high overall efficiency of greater than 55%. This means about one third less power consumption than that of other high level plate modulated 100 kW transmitters.

10-CHANNEL PRE-SET TUNING. Few controls and ample metering make the SW-100A the easiest tuning high power transmitter available. The servo system will automatically tune to any of ten pre-set channels in about 20 seconds. Auxiliary switching is possible for each channel for antenna switching, synthesizer programming, etc. Up to ten different frequencies from 3.2 to 22 MHz can be remembered, which allows pushbutton re-tuning to any pre-set frequency.

FIVE TUBE DESIGN. The entire transmitter employs just five tubes, with modern ceramic 4CV100,000E tetrode power tubes operating below manufacturer's dissipation ratings. All power supplies utilize long-life solid-state silicon rectifiers. Highest quality components, conservatively rated, are used throughout the SW-100A to assure a maximum degree of reliability. An integral hoist has been provided for ease of tube handling.

HIGH AVERAGE MODULATION CAPABILITY. The transmitter is capable of sustained high average modulation such as that experienced with trapezoidal audio processing—which means greater loudness at the receiver without increased transmitter carrier power. This is a feature of the high efficiency, DC coupled PDM modulator that avoids the use of large, inefficient transformers in the modulation process. Another feature of this high efficiency series type modulator is convenient front panel carrier power adjustment over a wide range.

VAPOR PHASE COOLING. The SW-100A employs the vapor cooling technique. This highly efficient method of heat transfer results in constant anode temperatures and extended tube life. This system allows a much smaller and more efficient heat exchanger than older water cooling systems.

MINIMUM FLOOR SPACE. Due to the elimination of large iron core components such as the modulation transformer and modulation reactor, the SW-100A requires only 7 square meters (76 square feet) of floor space. Advanced cabinet design provides easy accessibility to all components.

RF SECTION. The RF chain is conventional using a transistorized oscillator and RF amplifier, and a 4CX1500A tetrode tube amplifier to drive a single 4CV100,000E/H tetrode Class C power output stage.

An automatic drive control maintains the PA screen current at a pre-set value, eliminating the usual problem of over-dissipating the screen of a tetrode during tune-up.

THE MODULATION SYSTEM. Harris' Pulse Duration Modulator is characterized by low plate dissipation and low peak tube currents; peak cathode currents are about one-half that of other 100 kW transmitters. Average plate dissipation runs substantially below rated levels, and all peak voltages are maintained well below component ratings.

Wide frequency response is possible as large reactive components are not used in the modulation system. Control of the transmitter power output over a wide range is accomplished in a low-level stage of the modulator by means of a convenient front panel vernier control. No adjustment is necessary in any high power RF circuit.

PROTECTIVE CIRCUITS. All major components of the SW-100A are protected by circuit breakers. Tubes and transistors are guarded by overload relays or current-limiting devices.

A quick-acting circuit protects against damage by high voltage arcs by limiting the energy in such arcs to less than 10 watt seconds. Protection against voltage standing wave ratios of greater than 2.0 to 1.0 is provided. Both forward and reflected power are metered at the front panel.

In case of momentary RF overloads the SW-100A will recycle three times automatically. Should a third overload occur within a thirty second period, the transmitter will remain off until manually reset. However, if the time between overloads is greater than thirty seconds, continuous recycling will occur.

The SW-100A employs a unique method of transmitter protection. The modulator tube may be turned off in a low level state in about

TRAPEZOIDAL RESPONSE

Trapezoidal audio processing may be used to develop greater intelligence carrying sideband power without increasing the transmitter carrier power. To do this the audio input wave (A) is flattened at the top, by clipping, then reamplified to form a trapezoidal wave (B). The shaded areas in the diagram indicate the power gain.

The desired power gain lost, however, if this clipped, or flattened wave tilts downward due to poor low frequency response, or is rounded out again to its original shape by sub-standard high frequency response.

The SW-100A has the capability of passing a 100 Hz 12 dB clipped wave at 100% modulation with minimum tilt or rounding of the wave.

All the additional power gained by clipping the audio input is delivered at the output of the transmitter, thus increasing volume at the receiver.

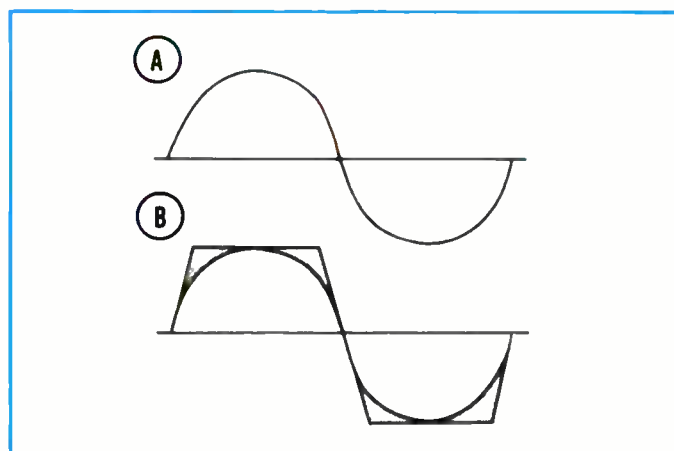

five microseconds. This removes the HV from the PA tube, thus eliminating most faults which normally occur. The HV supply (diodes and transformer) is capable of withstanding repeated short circuits without harming the unit.

An automatic gain control monitors the PA screen current. The PA may be operated with no HV but with screen voltage and under any condition of tuning with no damage being done to the PA tube.

Additional protection is provided by the HV circuit breaker. Tubes and transistors are also protected by current limiting impedances.

THE SERVO SYSTEM. The all solid-state servo system will automatically tune any of 10 pre-set channels in about 20 seconds. Each channel is "remembered" on one plug in card. Auxiliary switching also is provided on each pre-set channel card for antenna switching, programming, etc. The fast tuning time is made possible because the HV supply is not disabled during the tune cycle; the RF drive is turned off in a low level solid-state stage, and all tuning is done in parallel. When the tuning has been accomplished, the modulator is turned back on silently and smoothly.

TRANSMITTER LAYOUT. The standard SW-100A consists of two cabinets, a remote heat exchanger and an external high voltage power transformer and voltage regulator. Front doors and meter panel are magnetically latched.

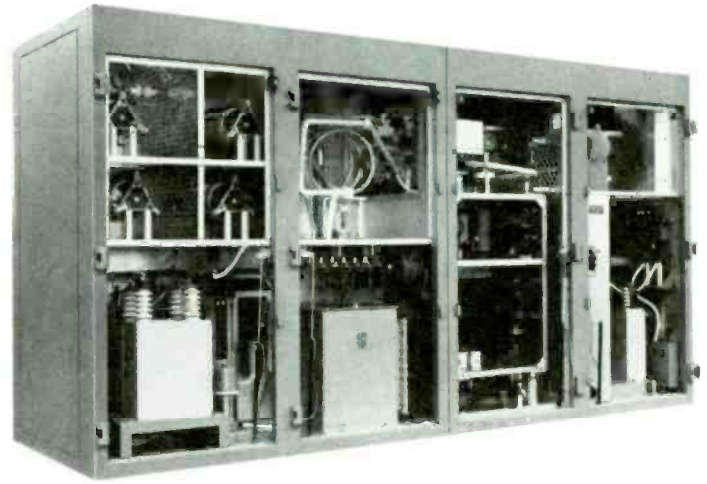

SW-100A, rear doors removed
(Air plenum not shown)



SW-100A with front doors removed

SW-100A BLOCK DIAGRAM

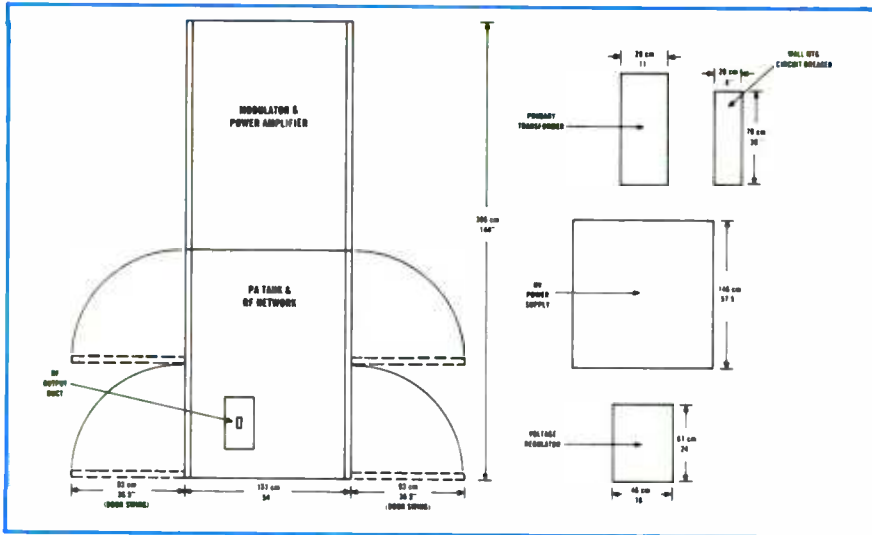
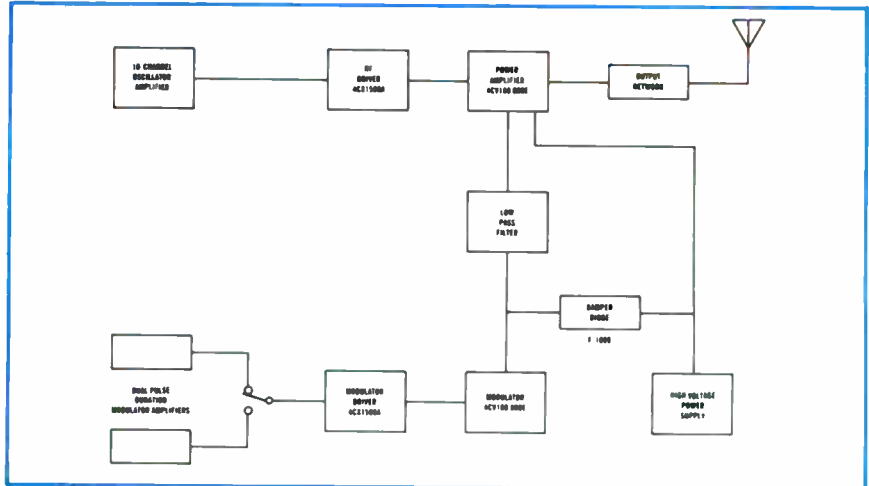

SW-100A FLOOR PLAN
 External heat exchanger, not shown is (58" wide x 36" deep x 44" high)
 147 cm wide x 91 cm deep x 112 cm high
 The remote heat exchanger may be installed up to 9 meters (30 feet) from the transmitter with the materials supplied.

SW-100A SPECIFICATIONS

- POWER OUTPUT:** 100,000 watts nominal unmodulated.
- RF FREQUENCY RANGE:** 3.2 to 22.0 MHz.
- METHOD OF TUNING:** Manual, or selection of 10 pre-set channels.
- RF OUTPUT IMPEDANCE:** 300 ohms balanced, 2.0 to 1 maximum VSWR.
- RF FREQUENCY STABILITY:** $\pm 1 \times 10^{-6}$ (± 22 Hz at 22 MHz).
- SPURIOUS AND HARMONIC EMISSION:** Less than 50 mW.
- CARRIER SHIFT:** Less than 2% at 95% modulation at 1000 Hz.
- AUDIO FREQUENCY RESPONSE:** ± 1.5 dB from 50 to 10,000 Hz referenced to 1,000 Hz at 95% modulation.
- AUDIO FREQUENCY DISTORTION:** Less than 3% from 50 to 10,000 Hz at 95% modulation.
- NOISE:** 55 dB below 1,000 Hz, 100% modulated level.
- AUDIO INPUT LEVEL:** 0 dBm ± 2 dB for 100% modulation.
- AUDIO INPUT IMPEDANCE:** 600/150 ohms, balanced or unbalanced.
- MODULATION LEVEL:** 100% sinusoidal, 10 minutes, 500-5000 Hz.
- TRAPEZOIDAL MODULATION:** Less than 5% tilt or overshoot, 100 Hz to 2000 Hz measured using 12 dB clipped sine wave.

- POWER INPUT:** Any specified voltage 380V to 480V, 3 phase, 50 or 60 Hz. Phase unbalance 5%, Regulation 5%.
- POWER CONSUMPTION:**
 - No modulation 180 kW
 - 30% modulation 190 kW
 - 100% modulation 250 kW
- POWER FACTOR:** Greater than 95%.
- VOLTAGE REGULATOR:** Electronic voltage regulation for all power supplies.
- OVERALL EFFICIENCY:** 55% @ average modulation.
- TUBES:** Two 4CV100,000E, two-4CX1500A; one F-1099.
- TEMPERATURE RANGE:** 0 to +50°C ambient air temperature.
- HUMIDITY:** 95% relative humidity, maximum.
- STORAGE TEMPERATURE:** -35°C to +60°C.
- ALTITUDE:** Up to 1829 meters (6000 feet) above sea level.
- CABINET DATA:** The two cabinets measure 366 cm (12 feet) wide, 137 cm (4.5 feet) deep, and 304 cm (10 feet) high.

SPECIFICATIONS ARE SUBJECT TO CHANGE WITHOUT NOTICE.

ORDERING INFORMATION

SW-100A, 100,000 watt short wave broadcast transmitter, with remote heat exchanger994-8629-001



HARRIS

WATER PURIFICATION UNIT

- Makes any water supply suitably pure for transmitter cooling
- Safety interlock system extends pump life
- Five-filter purification system
- LED resistivity meter monitors purity levels
- Recycle feature
- Mobile "wagon" cart for go-anywhere operation



Now an abundant quantity of pure, non-conductive cooling water for transmitters is as near as the closest water supply. The Harris Water Purification Unit makes even the dirtiest, contaminant-laden water suitable for Harris SW-100, SW-100A and VP-100A transmitters. No more buying distilled water at premium prices. Even pond water passed once through the Harris Water Purification Unit has a purity equivalent to several distillations—and it's a lot less expensive!

BACKGROUND

Pure water will not conduct electricity, but ordinary tap water is loaded with minerals and dissolved metals, making it an excellent electrical conductor. This conductivity is unacceptable in transmitter cooling applications. Water cooled and vapor cooled transmitters are designed with certain safeguards to protect components. Harris transmitters will shut down automatically if the coolant supply exceeds a safe level of contamination. The Harris Water Purification Unit can help prevent costly down time by keeping cooling water within operational parameters. It can purify about one-half gallon of water per minute.

OPERATION

The unit is easy to use—just plug it in near any water supply and put the collecting hose in place. Turning the multiport valve admits water. The raw water switch activates the main pump. A vacuum interlock senses when the water supply is gone and shuts off the pump. A second interlock switch is activated when the raw water tank is full.

The filter pump drains water from the raw water tank and sends it through the pre-filter, which removes all particles larger than five microns. Water is then routed through the four cartridges of the Barnstead NANOPURE unit. Cartridge 1 is a charcoal organic removal filter; Cartridges 2 and 3 are de-ionizing filters to remove minerals and dissolved metals; Cartridge 4 is a sub-micron filter which traps particles down to .2 microns in size. Reasonably priced, replaceable filters are available for the Barnstead unit. Finally, the water passes across the resistivity meter, which provides a continuous digi-

tal display of water resistivity to insure a quality above transmitter requirements.

BUILT-IN VERSATILITY

Purified water can be tapped off the outlet valve and pumped directly into the transmitter or holding container. Alternately, an angle valve can be used to shunt water into the clean water storage tank. Should the resistivity meter indicate the need for further purification, the multiport valve can be set to route from the clean water tank for recycling. In arid locales

where ready water availability is questionable, old water may be drained from the transmitter and recycled for further use.

CONSTRUCTION

Assembled on a sturdy, 4-wheeled cart, the Harris Water Purification Unit is extremely mobile and can be pulled from one location to another in multi-transmitter installations. Automatic type "knuckle" steering prevents accidental tipovers. Modern all-steel, blind rivet construction assures exceptional durability.

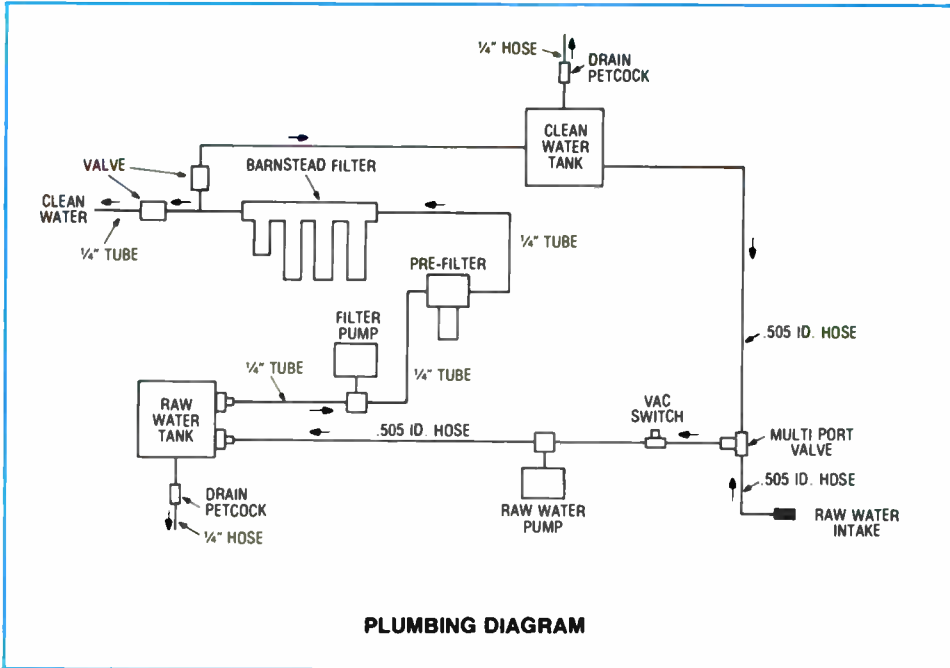

HARRIS WATER PURIFICATION UNIT SPECIFICATIONS

ELECTRICAL

Power Requirements: 115 VAC, 50/60 Hz, 9 amperes maximum.
230 VAC, 50/60 Hz, 4.5 amperes maximum.

MECHANICAL

Height: 48 inches (121.9 cm)
Width: 26 inches (66 cm)
Length: 52 inches (132 cm)
Weight (unpacked): Approximately 350 pounds dry (159 kg)

Raw Water Pump Flow: Approximately 10 gpm (37.8 lpm)

Filter Water Pump Flow: Approximately 0.5 gpm (1.9 lpm)

Raw Water Tank Capacity: 7 gallons (26.5 liters) (5 gallons useable—2 gallons for settling)

Clean Water Tank Capacity: 7 gallons (26.5 liters)

Raw Water Intake Purity: Maximum salt concentration of 500 parts per million (if salt concentration exceeds the limit, filter life will be substantially reduced).

SPECIFICATIONS SUBJECT TO CHANGE WITHOUT NOTICE

ORDERING INFORMATION

Harris Water Purification Unit 994-8676-001
Packing Check List 992-6013-001



HARRIS

SW-50A

**50,000 Watt
Short Wave
Broadcast
Transmitter**

- High level Pulse Duration Modulation
- Exceeds 57% overall efficiency
- 10-Channel pre-set tuning, crystals included
- Low power consumption
- Only five tubes for 50 kW
- Vapor phase cooling
- Designed for trapezoidal programming
- Minimum floor space
- Full front and rear accessibility

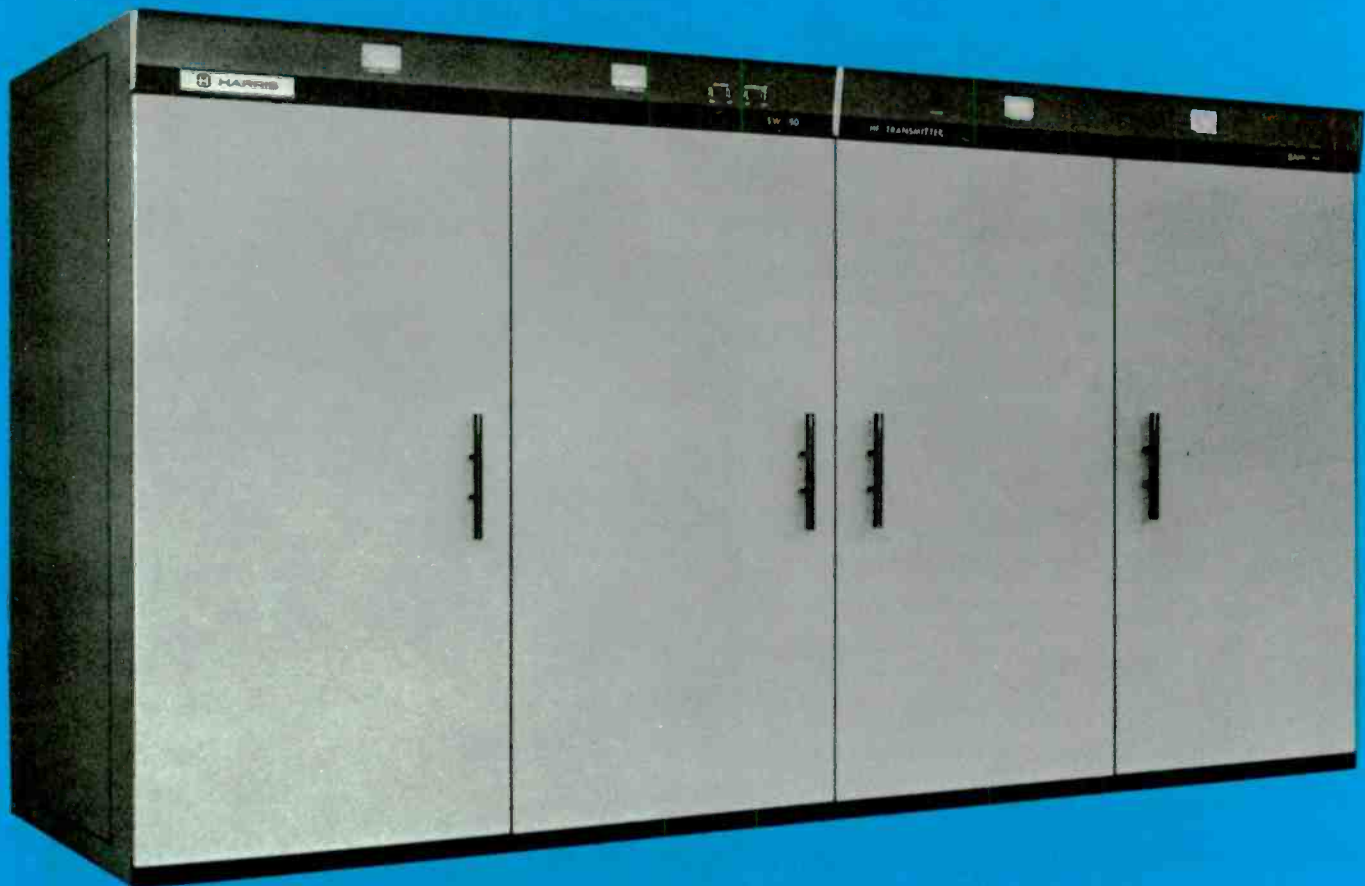

Harris' SW-50A is a high-level, plate modulated short wave broadcast transmitter, featuring automatic 10-channel pre-set tuning. Utilizing the exclusive Pulse Duration Modulator, the SW-50A provides higher efficiency, lower operating costs and overall performance superior to that of any other short wave transmitter in the 50 kilowatt power range. The transmitter is capable of operating at any frequency between 3.2 and 22 MHz.

HIGH EFFICIENCY..... EXCEEDS 57%. The Pulse Duration Modulator employed in the SW-50A is almost 90% efficient (instead of the usual 50% to 60%), enabling the transmitter to achieve an unusually high overall efficiency of greater than 57%. This means about one third less power consumption than that of other high level plate modulated 50 kW transmitters.

10-CHANNEL PRE-SET TUNING. Few controls and ample metering make the SW-50A the easiest tuning high power transmitter available. The servo system will automatically tune to any of ten pre-set channels in about 20 seconds. Auxiliary switching is possible for each channel for antenna switching, synthesizer programming, etc. Up to ten different frequencies from 3.2 to 22 MHz can be remembered, which allows pushbutton re-tuning to any pre-set frequency.

FIVE TUBE DESIGN. The entire transmitter employs just five tubes, with modern ceramic 4CV50,000E tetrode power tubes operating below manufacturer's dissipation ratings. All power supplies utilize long-life solid-state silicon rectifiers. Highest quality components, conservatively rated, are used throughout the SW-50A to assure a maximum degree of reliability. An integral hoist has been provided for ease of tube handling.

HIGH AVERAGE MODULATION CAPABILITY. The transmitter is capable of sustained high average modulation such as that experienced with trapezoidal audio processing—which means greater loudness at the receiver without increased transmitter carrier power. This is a feature of the high efficiency, DC coupled PDM modulator that avoids the use of large, inefficient transformers in the modulation process. Another feature of this high efficiency series type modulator is convenient front panel carrier power adjustment over a wide range.

VAPOR PHASE COOLING. The SW-50A employs the vapor cooling technique. This highly efficient method of heat transfer results in constant anode temperatures and extended tube life. This system allows a much smaller and more efficient heat exchanger than older water cooling systems.

MINIMUM FLOOR SPACE. Due to the elimination of large iron core components such as the modulation transformer and modulation reactor, the SW-50A requires only 7 square meters (76 square feet) of floor space. Advanced cabinet design provides easy accessibility to all components.

RF SECTION. The RF chain is conventional using a transistorized oscillator and RF amplifier, and a 4CX1500A tetrode tube amplifier to drive a single 4CV50,000E tetrode Class C power output stage.

An automatic drive control maintains the PA screen current at a pre-set value, eliminating the usual problem of over-dissipating the screen of a tetrode during tune-up.

THE MODULATION SYSTEM. Harris' Pulse Duration Modulator is characterized by low plate dissipation and low peak tube currents; peak cathode currents are about one-half that of other 50 kW transmitters. Average plate dissipation runs substantially below rated levels, and all peak voltages are maintained well below component ratings.

Wide frequency response is possible as large reactive components are not used in the modulation system. Control of the transmitter power output over a wide range is accomplished in a low-level stage of the modulator by means of a convenient front panel vernier control. No adjustment is necessary in any high power RF circuit.

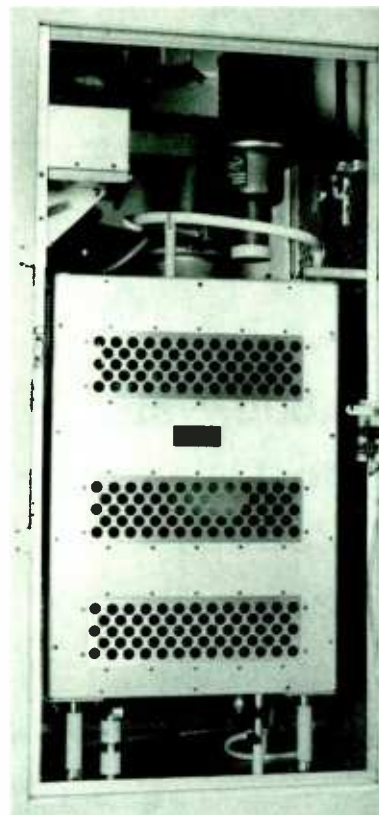

Rear view of RF isolation box showing power amplifier tube assembly and vapor phase cooling boiler.

PROTECTIVE CIRCUITS. All major components of the SW-50A are protected by circuit breakers. Tubes and transmitters are guarded by overload relays or current-limiting devices.



SW-50A with front doors removed.

A quick-acting circuit protects against damage by high voltage arcs by limiting the energy in such arcs to less than 10 watt seconds. Protection against voltage standing wave ratios of greater than 2.0 to 1.0 is provided. Both forward and reflected power are metered at the front panel.

In case of momentary RF overloads the SW-50A will recycle three times automatically. Should a third overload occur within a thirty second period, the transmitter will remain off until manually reset. However, if the time between overloads is greater than thirty seconds, continuous recycling will occur.

The SW-50A employs a unique method of transmitter protection. The modulator tube may be turned off in a low level state in about five microseconds. This removes the HV from the PA tube, thus eliminating most faults which normally occur. The HV supply (diodes and transformer) is capable of withstanding repeated short circuits without harming the unit.

An automatic gain control monitors the PA screen current. The PA may be operated with no HV but with screen voltage and under any condition of tuning with no damage being done to the PA tube.

Additional protection is provided by the HV circuit breaker. Tubes and transistors are also protected by current limiting impedances.

THE SERVO SYSTEM. The all solid-state servo system will automatically tune any of 10 pre-set channels in about 20 seconds. Each channel is "remembered" on one plug-in card. Auxiliary switching also is provided on each pre-set channel card for antenna switching, programming, etc. The fast tuning time is made possible because the HV supply is not disabled during the tune cycle; the RF drive is turned off in a low level solid-state stage, and all tuning is done in parallel. When the tuning has been accomplished, the modulator is turned back on silently and smoothly.

TRANSMITTER LAYOUT. The standard SW-50A consists of two cabinets, a remote heat exchanger and an external high voltage power transformer and voltage regulator. Front doors and meter panel are magnetically latched.

TRAPEZOIDAL RESPONSE

Trapezoidal audio processing may be used to develop greater intelligence carrying sideband power without increasing transmitter carrier power. To do this the audio input wave (A) is flattened at the top, by clipping, then reamplified to form a trapezoidal wave (B). The shaded areas in the diagram indicate the power gain.

The desired power gain is lost, however, if this clipped, or flattened, wave tilts downward due to poor low frequency response, or is rounded out again to its original shape by sub-standard high frequency response.

The SW-50A has the capability of passing a 100 Hz 12 dB clipped wave at 100% modulation with minimum tilt or rounding of the wave.

All the additional power gained by clipping the audio input is delivered at the output of the transmitter, thus increasing volume at the receiver.

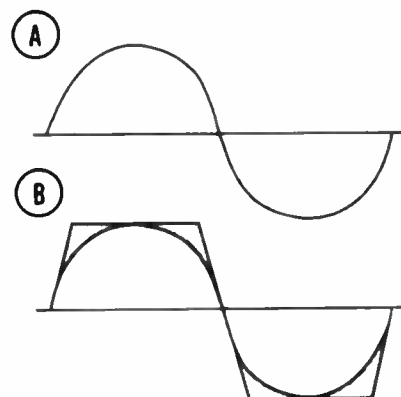

SW-50A BLOCK DIAGRAM

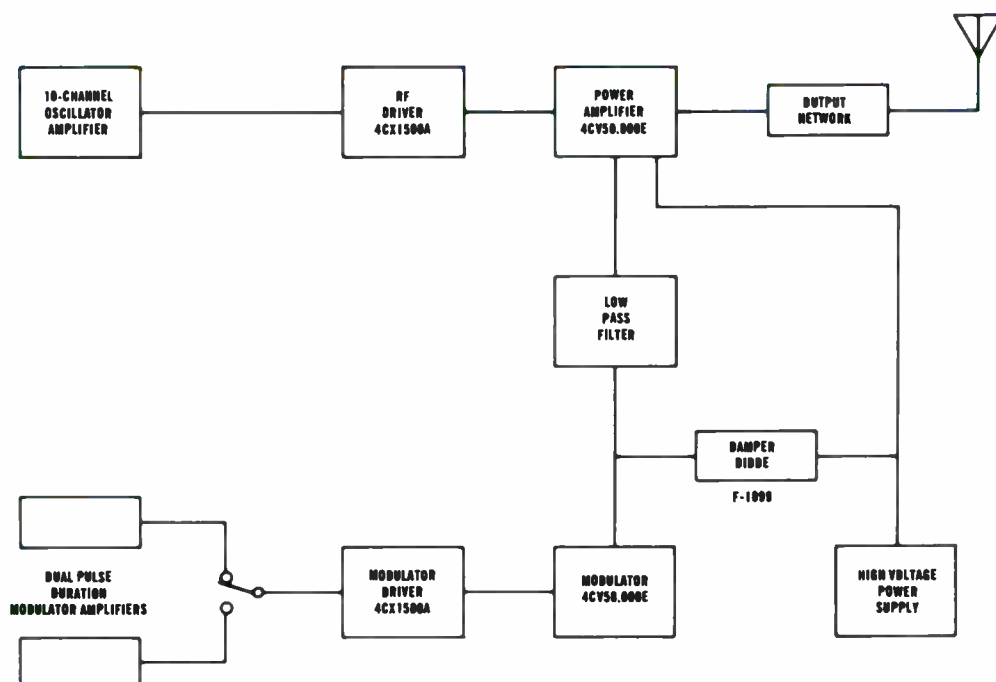

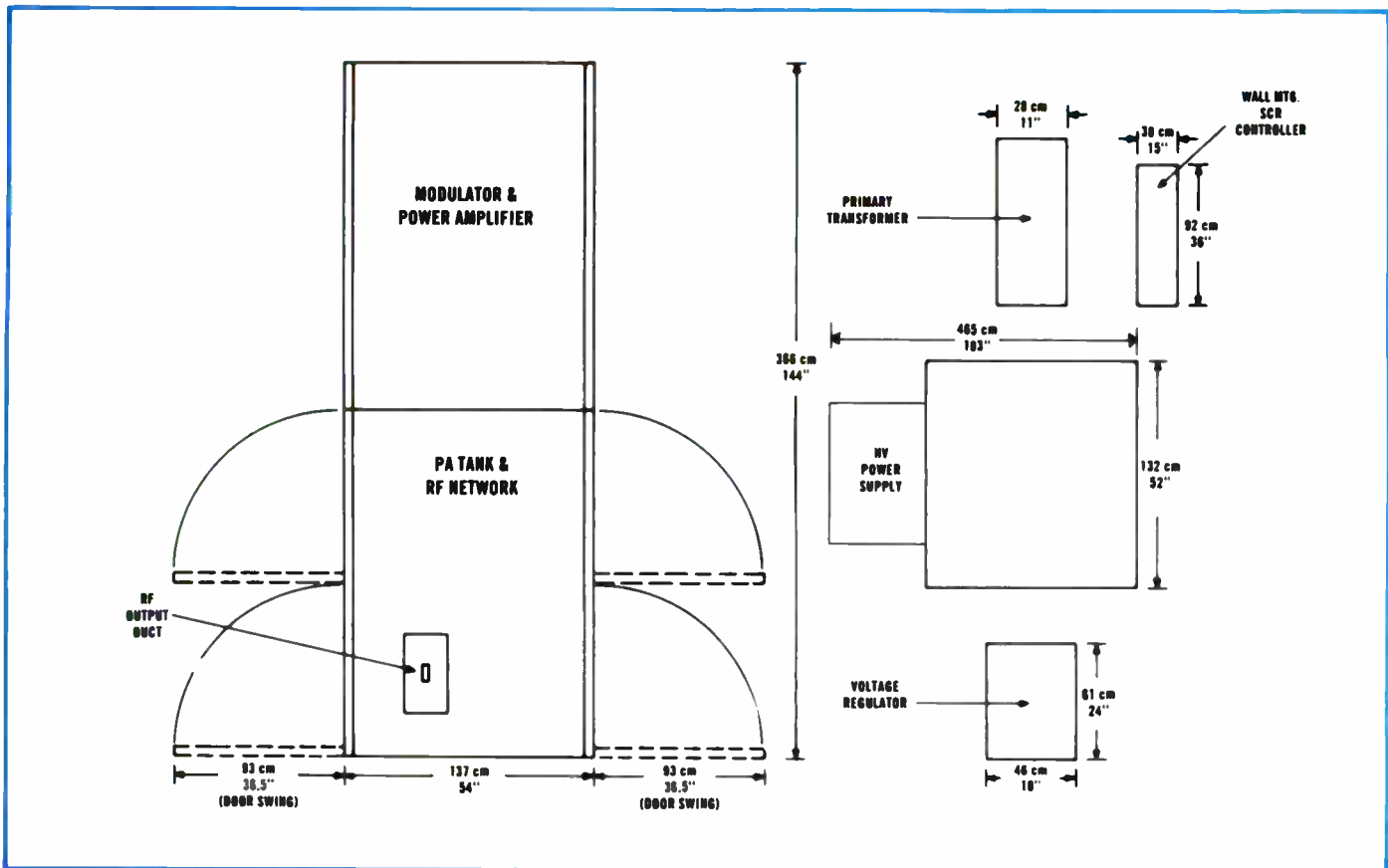

SW-50A FLOOR PLAN—External heat exchanger, not shown is (58' wide × 36' deep × 44' high) 147 cm wide × 91 cm deep × 112 cm high. The remote heat exchanger may be installed up to 9 meters (30 feet) from the transmitter with the materials supplied.

SW-50A SPECIFICATIONS

POWER OUTPUT: 50,000 watts nominal unmodulated.

RF FREQUENCY RANGE: 3.2 to 22.0 MHz.

METHOD OF TUNING: Manual, or selection of 10 pre-set channels.

RF OUTPUT IMPEDANCE: 300 ohms balanced, 2.0 to 1 maximum VSWR.

RF FREQUENCY STABILITY: $\pm 1 \times 10^{-6}$ (± 22 Hz at 22 MHz).

SPURIOUS AND HARMONIC EMISSION: Less than 50 mW.

CARRIER SHIFT: Less than 2% at 95% modulation at 1000 Hz.

AUDIO FREQUENCY RESPONSE: ± 1.5 dB from 50 to 10,000 Hz referenced to 1000 Hz at 95% modulation.

AUDIO FREQUENCY DISTORTION: Less than 3% from 50 to 10,000 Hz at 95% modulation.

NOISE: 55 dB below 1000 Hz, 100% modulated level.

AUDIO INPUT LEVEL: 0 dBm ± 2 dB for 100% modulation.

AUDIO INPUT IMPEDANCE: 600/150 ohms, balanced or unbalanced.

MODULATION LEVEL: 100% sinusoidal, 60 minutes, 500-5000 Hz.

TRAPEZOIDAL MODULATION: Less than 5% tilt or overshoot, 100 Hz to 2000 Hz measured using 12 dB clipped sine wave.

POWER INPUT: Any specified voltage 380V to 480V, 3 phase, 50 or 60 Hz. Phase unbalance 5%, Regulation 5%.

POWER CONSUMPTION:

No modulation	89 kW
30% modulation	92 kW
100% modulation	130 kW

POWER FACTOR: Greater than 95%.

VOLTAGE REGULATOR: Electronic voltage regulation for all power supplies other than high voltage.

OVERALL EFFICIENCY: 57% or greater @ average modulation.

TUBES: Two 4CV50,000E, two 4CX1500A, one F-1099.

TEMPERATURE RANGE: 0 to +50°C ambient air temperature. Sea level decrease 2°C/1000 ft. altitude (38°C @ 6000 ft.)

HUMIDITY: 95% relative humidity, maximum.

STORAGE TEMPERATURE: -35°C to +60°C.

ALTITUDE: Up to 1829 meters (6000 feet) above sea level.

CABINET DATA: The two cabinets measure 366 cm (12 feet) wide, 137 cm (4.5 feet) deep, and 304 cm (10 feet) high.

SPECIFICATIONS ARE SUBJECT TO CHANGE WITHOUT NOTICE.

ORDERING INFORMATION

SW-50A, 50,000 watt short wave broadcast transmitter, with remote heat exchanger994-8630-001



HARRIS

FMD-50K

50-Kilowatt
Dual FM
Broadcast
Transmitter

- Combines two 25-kilowatt amplifiers for highest on-air reliability
- Only two low stress PA tubes, yielding low operating cost and long tube life
- Wide RF bandwidth for maximum stereo and SCA performance
- Solid-state control logic and automatic power control minimize adjustments
- Featuring the superior MS-15 maximum signal FM exciter
- DSM stereo generator typically yields 50 dB separation for increased stereo realism
- DTR overshoot filter maximizes modulator level

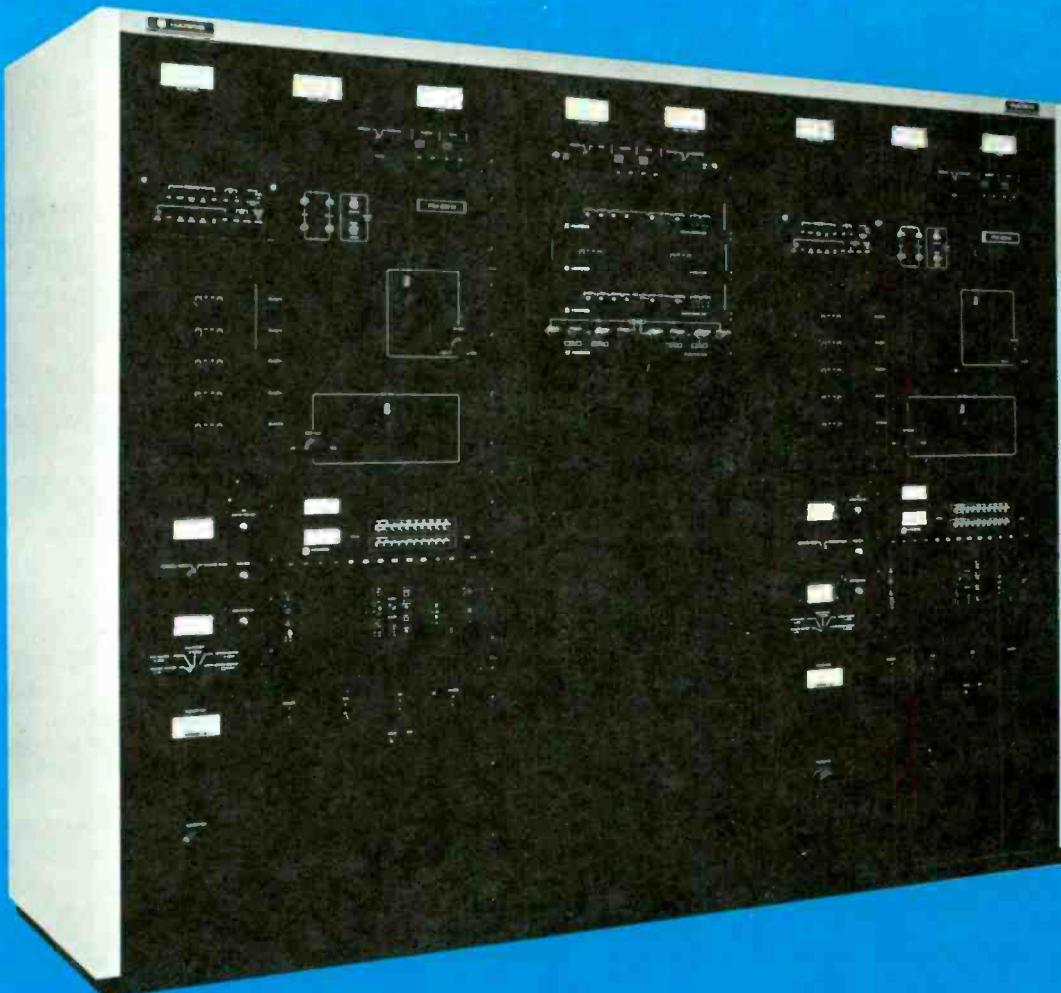

FMD-50K... dual configuration for

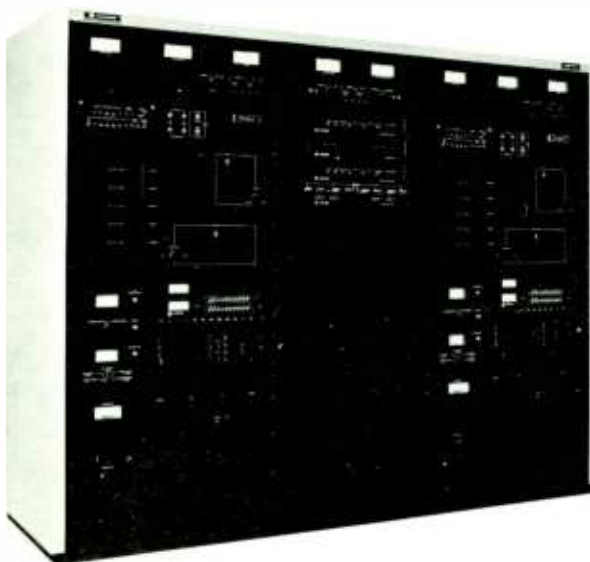

The FMD-50K dual 50-kilowatt transmitter offers real protection against off-air time through redundancy, and through extensive use of solid-state circuitry. Only two tubes are employed in the entire FMD-50K... high-gain, highly efficient 8990 tetrodes used as the final power amplifiers. The 8990 uses a wavy fin radiator which provides exceptional cooling at reduced air requirements, for quiet operation. The quarter-wave PA cavity design eliminates troublesome sliding contacts for tuning, and assures wide RF bandwidth. This results in a signal path that is transparent to the MS-15 exciter.

The **basic** FMD-50K transmitter consists of two 25-kilowatt amplifiers, and a center control cabinet. It provides redundancy in all areas except the exciters. In case emergency operation is required, you stay on the air at one-quarter normal power output. An even higher level of redundancy is achieved in the **complete** FMD-50K through an optional arrangement of switches, sensors and circuits that make the FMD-50K totally redundant from audio input to RF output.

The FMD-50K with the RF output switching option provides the capability of automatically switching either transmitter directly to the antenna, thus providing one-half normal operating power in the event of a transmitter malfunction.

With the addition of the automatic exciter switching option, automatic backup exciter protection is provided. Also, an optional RF input patch panel is available to connect either exciter directly to either transmitter by bypassing all of the automatic exciter switching equipment.

SOLID-STATE IPA'S

The redundancy of the dual FMD-50K is heightened when the IPA in each 25-kilowatt amplifier is considered. The IPA stages are multiple solid-state amplifiers combined in such a manner that failure of one amplifier stage will not cause a total loss of IPA RF power. The IPA solid-state modules in the PA are identical to those used in the booster amplifier for the MS-15. The wide use of solid-state RF power circuits means that the FMD-50K uses only two tubes!

LOW OPERATING COST

With today's mounting energy costs, transmitter efficiency must be a major consideration in any purchase. 77% efficiency in the final power amplifiers, high efficiency in all amplifier circuits, and conservatively rated components result in comparatively low power consumption and low operating stress on heat generating components in the FMD-50K. This adds up to very impressive savings in operating and maintenance costs.

FINEST STEREO PERFORMANCE

Featuring the advanced-design MS-15 exciter, Harris' FMD-50K provides the cleanest and the loudest stereo signal of any 50-kilowatt FM transmitter available today. The DSM (Digitally Synthesized Modulation) stereo generator allows the transmitter to provide stereo separation of 40 dB minimum (50 dB typical), 30-15,000 Hz—while the DTR (Dynamic Transient Response) filter permits a 2 to 6 dB increase in loudness, with no degradation of audio quality, by limiting overshoot to 2% or less.

The FMD-50K may be equipped for mono or stereo operation, with or without SCA.

The design versatility of the MS-15 exciter allows you to order mono operation originally, then add stereo and/or SCA at a later date by plugging the appropriate module(s) into the exciter. The FMD-50K is equipped for wideband composite input in its standard configuration.

AUTOMATIC POWER CONTROL

The FMD-50K automatically monitors power output, and maintains the output at the desired level. This standard feature insures against out-of-tolerance power conditions. Furthermore, the power set point can be remotely adjusted independently of the limit points to allow operator control of power output. During maintenance periods, the automatic power control may be switched off.

VSWR PROTECTION

VSWR protection is mandatory in any high-power transmitter—therefore, Harris has incorporated this as a standard feature in the FMD-50K. A high VSWR condition will cause the transmitter to recycle... if three overloads occur within a given time period, the transmitter will shut down until manually restarted. The transmitter may also be programmed for single VSWR overload shutdown.

CONTROL CIRCUITRY

The FMD-50K is controlled by solid-state logic circuitry. The logic circuitry not only controls basic On/Off functions, but also monitors critical stages for overload conditions. Should an overload occur, the transmitter will recycle automatically.

The control logic used in the FMD-50K interfaces directly with most remote control systems, eliminating the need for an additional remote control interface. The control signals are momentary low current contacts. The transmitter output parameters are buffered, and all status indicators can be remotely.

METERING AND VISUAL AIDS

Major functions, including combined output power, VSWR and reject load power are displayed on easy-to-read 4-inch meters in the center cabinet. Complete monitoring of operating functions of the individual 25-kilowatt amplifiers are also displayed. Low-level parameters of each amplifier are displayed on a multimeter, and IPA RF output and reflected power are indicated on another meter. Filament voltage is measured by a true RMS circuit.

The FMD-50K provides a variety of indicators as troubleshooting aids and quick

complete redundancy ... only two tubes

references. These include illuminated On/Off pushbuttons and numerous LED status indicators.

HV POWER SUPPLIES

The two high voltage power supplies are housed in separate cabinets, and provide the plate and screen voltage. The conservatively-rated three-phase plate supplies use silicon rectifiers with AC line transient protection.

COMPACT SIZE

The trim FMD-50K cabinet configuration measures only 90.2" wide, 72" high and

30.5" deep. Additionally, the HV power supplies may be located in any convenient spots remote from the PA cabinets.

GENERAL

There are many other operational and convenience features incorporated into the FMD-50K. These include:

Line Loss Protection—Built-in protection against total AC failure and loss of phase is provided. The FMD-50K will restart automatically following a total power failure, while loss of a single phase will shut down the transmitter.

High Altitude Rating—High capacity, direct-drive blowers deliver sufficient air to cool the transmitter at altitudes up to 10,000 feet (3048 meters).

Additional Protection — Magnetic circuit breakers are utilized to protect the blower motors, the filament supplies, the IPA supplies and the bias supplies. A safety interlock system and a drop solenoid system discharge power supplies to safe levels.

Automatic Transmitter System Compatibility—The simple control logic interface and full metering in the FMD-50K permit ATS operation.

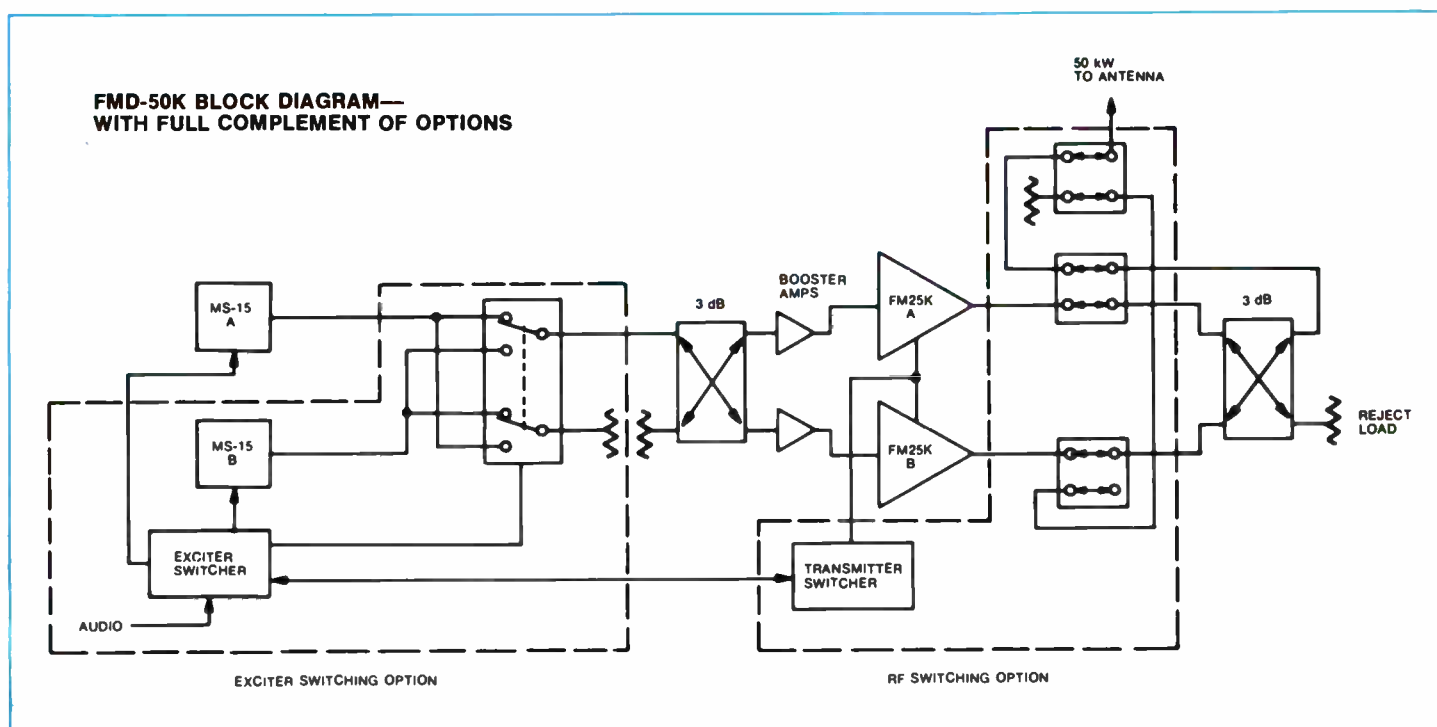

HARRIS' FMD-50K DUAL FM TRANSMITTER CONFIGURATIONS

BASIC FMD-50K DUAL SYSTEM

- Two FM-25K transmitters, less exciters.
- One MS-15 exciter.
- One dual RF booster amplifier with low power hybrid coupler and reject load.
- One 19-inch center cabinet with control and metering circuitry.
- One high power hybrid coupler with interconnecting transmission line components.
- One 12.5-kilowatt reject load.

- One MS-15 exciter.
- One dual RF booster amplifier with low power hybrid coupler and reject load.
- One 19-inch center cabinet with control metering and RF control logic assembly.
- One floor-mounted frame assembly with three high power coaxial switches, one high power hybrid combiner, and one 12.5-kilowatt reject load.
- All necessary interconnecting transmission line components.

OPTIONAL AUTOMATIC EXCITER SWITCHING

- One automatic RF control logic assembly.

FMD-50K WITH AUTOMATIC RF OUTPUT SWITCHING

- Two FM-25K transmitters, less exciters.

- One coaxial transfer switch.
- One test load for exciter.
- All necessary cabling for system interconnect.
- (Requires second exciter, which is not included in this option package).

ADDITIONAL OPTIONS FOR FMD-50K

- Mono generator(s).
- Stereo generator(s).
- SCA generator(s).
- RF input manual patch panel for use with exciter switching option.
- 80-kilowatt water-cooled test load.
- Heat exchanger for test load.

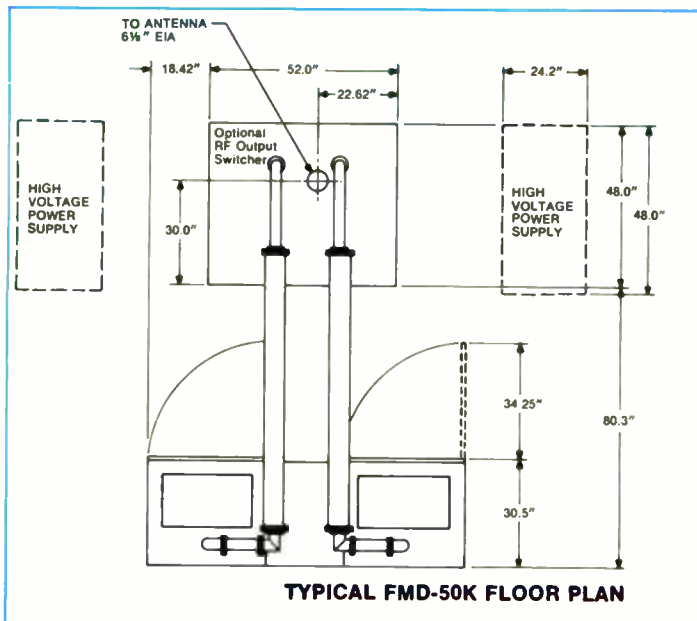

FMD-50K SPECIFICATIONS

GENERAL

POWER OUTPUT: 20 kW to 50 kW.
FREQUENCY RANGE: 87.5 to 108 MHz, tuned to specified operating frequency.
RF OUTPUT IMPEDANCE: 50 ohms.
OUTPUT TERMINATION: 6 1/2" EIA flange.
FREQUENCY STABILITY: ±300 Hz 0° to 45°C TCXO.
TYPE OF MODULATION: Direct Carrier Frequency Modulation.
MODULATION CAPABILITY: ±100 kHz.
AC INPUT POWER: 208/240 V, 3-phase, 50/60 Hz, 360/415 V, 3-phase, 50/60 Hz. Power consumption: 80,000 watts (approx.). 115 V as available.
RF HARMONICS: Suppression meets all FCC requirements.
ALTITUDE: 10,000 feet (3048 meters).
AMBIENT TEMPERATURE RANGE: -20°C to +45°C (-4° to +113°F).
MAXIMUM VSWR: 1.7 to 1.
SIZE: Transmitter: 90.2"W (229 cm) x 72"H (183 cm) x 30.5"D (77.5 cm). HV power supply cabinets: (each) 48"W (122 cm) x 60.2"H (153 cm) x 24.2"D (61.5 cm).
FINISH: White, blue and black.
WEIGHT AND CUBAGE (Approximate): Export: 7000 lbs. (3178 kg). Domestic: 6800 lbs. (3087 kg). Cubage: 400 cubic feet (11.3 cubic meters).

MONAURAL MODE

AUDIO INPUT IMPEDANCE: 600 ohms balanced, resistive, adaptable to other impedances.
INPUT FILTER: Controlled response L-F, defeatable.
AUDIO INPUT LEVEL: +10 dBm ±1 dB for 100% modulation at 400 Hz.
AUDIO FREQUENCY RESPONSE: Standard 75 microsecond FCC pre-emphasis curve ±0.5 dB, 30-15,000 Hz. Selectable: flat, 25 or 50 microsecond pre-emphasis.

HARMONIC DISTORTION: 0.2% or less, 30-15,000 Hz.
IMD: 0.2%, 60/7000 Hz, 4:1 ratio.
FM NOISE: 68 dB below 100% modulation (ref. 400 Hz @ ±75 kHz deviation).
AM NOISE: 50 dB below reference carrier AM modulation 100%.

STEREOPHONIC MODE

TYPE OF MODULATION: Digitally Synthesized Modulation (DSM).
AUDIO INPUT IMPEDANCE: (left and right) 600 ohms balanced, resistive. Adaptable to other impedances.
AUDIO INPUT LEVEL: (left and right) +10 dBm ±1 dB for 100% modulation at 400 Hz.
AUDIO FREQUENCY RESPONSE: (left and right) standard 75 microsecond, FCC pre-emphasis curve ±0.5 dB 30-15,000 Hz. Selectable: flat, 25 or 50 microsecond pre-emphasis.
INPUT FILTERING: 15 kHz LPF, 45 dB rejection at 19 kHz.
OVERSHOOT PROTECTION: Dynamic transient response (DTR) filter.
AUDIO TRANSIENT RESPONSE: 2% maximum overshoot beyond steady state. Defeatable for test purposes.
HARMONIC DISTORTION: (left or right) 0.4% or less, 30-15,000 Hz.
IMD: 0.4%, 60/7000 Hz, 4:1 ratio.
FM NOISE: (left or right) 65 dB minimum below 100% modulation. Reference: 400 Hz, 75 microsecond de-emphasis, ±75 kHz deviation.
PILOT OSCILLATOR: Crystal controlled.
PILOT STABILITY: 19 kHz ±1 Hz, 0° to 45°C.
PILOT PHASE: Automatically controlled.
STEREO SEPARATION: 40 dB minimum 30-15,000 Hz.
CROSSTALK: (main to stereo sub-channel or stereo sub-to main channel) 45 dB below 90% modulation.
SUB CARRIER SUPPRESSION: 50 dB below 90% modulation.
76 kHz SUPPRESSION: 60 dB minimum below 100% modulation.
MODES: Stereo, mono (L + R), mono (L), mono (R). Remoteable.

SCA SPECIFICATIONS

MODULATION: Direct FM.
FREQUENCY: 41 or 67 kHz programmable, any frequency between 25 and 75 kHz on special order.
FREQUENCY STABILITY: ±500 Hz.
MODULATION CAPABILITY: ±7.5 kHz.
AUDIO INPUT IMPEDANCE: 600 ohms balanced (AC coupled) and 2000 ohms unbalanced (DC coupled).
AUDIO INPUT LEVEL: +10 dBm, ±1 dB for 100% modulation at 400 Hz.
AUDIO FREQUENCY RESPONSE: 41 kHz and 67 kHz, 150 microsecond pre-emphasis ±1 dB, standard. Selectable: flat, 50 or 75 microsecond pre-emphasis.
INPUT FILTERING: Programmable LPF, 4.5 kHz standard.
DISTORTION: Less than 1%, 30-5000 Hz, ±5 kHz deviation.
FM NOISE: (main channel not modulated) 55 dB minimum (ref: 100% = ±5 kHz deviation at 400 Hz).
CROSSTALK: (SCA to main or stereo sub-channel): -60 dB or better.
CROSSTALK: (main or stereo sub-channel to SCA): 50 dB below ±5 kHz deviation of SCA, with mono or stereo channels modulated by frequencies 30-15,000 Hz, SCA demodulated with 150 microsecond de-emphasis.
CROSSTALK: SCA to SCA (41 kHz/67 kHz) 50 dB demodulated with 150 microsecond de-emphasis.
AUTOMATIC MUTE LEVEL: Variable from 0 to -30 dBm.
MUTE DELAY: Adjustable 0.5 to 20 seconds.
INJECTION LEVEL: 1% to 30% of composite. Adjustable.

WIDEBAND MODE

INPUT IMPEDANCE: Greater than 5000 ohms resistive, unbalanced.
INPUT LEVEL: 1.0 VRMS nominal for ±75 kHz deviation.
AMPLITUDE RESPONSE: ±0.25 dB, 30 Hz to 75 kHz.
PHASE LINEARITY: ±2°, 30 Hz to 75 kHz.

SPECIFICATIONS SUBJECT TO CHANGE WITHOUT NOTICE.

ORDERING INFORMATION

FMD-50K, dual 50-kilowatt FM transmitter, with automatic RF output switching, for wideband operation	994-8455-001
FMD-50K, dual 50-kilowatt FM transmitter, basic system, for wideband operation	994-8455-002
Automatic exciter switching option (does not include second exciter)	994-8456-001
MS-15 exciter (does not include generator modules)	994-7950-002
Monaural generator (add for mono operation)	994-8019-001
DSM stereo generator with DTR (add for stereo operation)	994-8020-001
SCA generator (add for SCA operation, specify 41 or 67 kHz)	994-7992-001
RF input patch panel	994-8473-001
80-kilowatt water-cooled test load	700-0121-000
Heat exchanger for test load	432-0257-000



HARRIS

FM-40K

**40-Kilowatt
FM
Broadcast
Transmitter**

- Combines two 20-kilowatt amplifiers for highest reliability
- Solid-state Maximum Signal Exciter—MS-15
- Patented DSM (Digitally Synthesized Modulation) stereo generator provides separation exceeding accurate measurement capability of most monitors
- DTR (Dynamic Transient Response) filter technique limits overshoot to 2% or less, permitting a 2 to 6 dB increase in loudness with no audio quality degradation
- Lowest operating cost
- Stable, easy output tuning
- Built-in connections for remote control
- Automatic recycling
- Full metering
- Plug-in mono, stereo and SCA generators



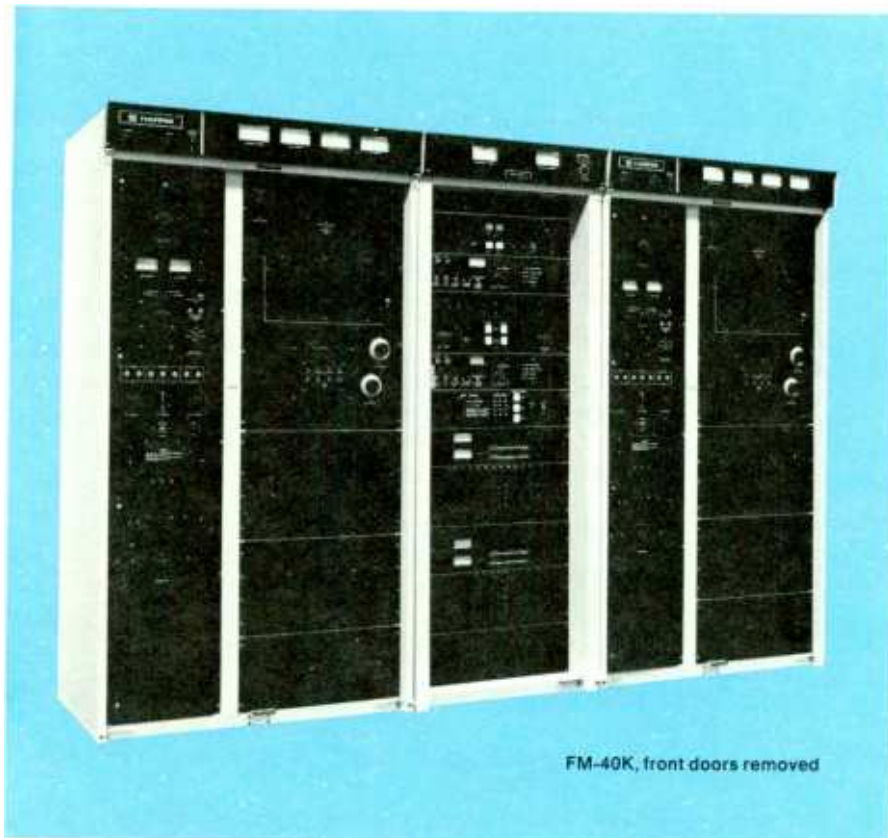

FM-40K, front doors removed

Reliability through redundancy—that's the story on Harris' FM-40K, 40-kilowatt transmitter.

The basic FM-40K transmitter system consists of two 20-kilowatt amplifiers, and a center control cabinet containing the MS-15 exciter—and provides redundancy in all areas except the exciter and isolation amplifier. In case emergency operation is required, you stay on the air at one-quarter normal power output.

The complete 40-kilowatt FM transmitter system includes an optional Automatic Exciter Switching Kit and RF Output Switching Kit—and provides total redundancy! Should a malfunction occur anywhere in the system, you are still on the air at one-half normal power!

In the basic system, outputs of each amplifier are coupled through harmonic filters to the output combining network. This hybrid network sums the two 20-kilowatt signals to produce a 40-kilowatt output to the transmission line. However, the two amplifiers remain isolated from each other.

With the addition of the Automatic Exciter Switching Kit, automatic backup exciter protection is provided. And with the further addition of the RF Output Switching System, power output becomes one-half the normal output during emergency operation. Either or both of these options may be included in the FM-40K at the time you order—or added later in the field.

FINEST STEREO PERFORMANCE

Featuring the advanced-design MS-15 exciter, Harris' FM-40K provides the cleanest and the loudest stereo signal of any 40-kilowatt FM transmitter available today. The DSM (Digitally Synthesized Modulation) stereo generator allows the transmitter to provide stereo separation of 40 dB minimum (50 dB typical), 30-15,000 Hz—while the DTR (Dynamic Transient Response) filter permits a 2 to 6 dB increase in loudness, with no degradation of audio quality, by limiting overshoot to 2% or less.

The FM-40K may be equipped for mono or stereo operation, with or without SCA. The design versatility of the MS-15 exciter allows you to order for mono operation originally, then add stereo and/or SCA at a later date by plugging the appropriate module(s) into the exciter.

LOWEST OPERATING COST

In the FM-40K, each of the 20-kilowatt amplifiers operates at 80% efficiency or better. Add to this conservatively rated components and you have the lowest operating cost of any FM transmitter in the 40-kilowatt power range. The 4CX15,000A output tube in each 20-kilowatt amplifier assures excellent performance—and runs

at only one-third its dissipation rating for maximum service life.

VARI-LINE SILVER-PLATED TANK

Vari-Line is an advanced, Harris-developed method of tuning a single-ended FM amplifier for optimum output efficiency. A portion of a parallel tubular 2- $\frac{1}{8}$ -inch copper transmission line (silver plated for efficient RF service) is made variable in order to inductively tune the line to operating frequency. This reduces the complexity of sliding contacts and consequent maintenance problems.

With Vari-Line tuning, greater reliability is possible. Mica capacitors are not used in the tank circuit.

DUAL HV SILICON POWER SUPPLIES

Two separate three-phase HV power supplies are used for each 20-kilowatt amplifier. With each amplifier one HV supply—for PA plate voltage—is housed in a separate enclosure; the other supply, which powers the IPA plate and screen circuit, and the PA screen, is housed in the amplifier cabinet.

The FM-40K employs a special power supply protective circuit to assure that transient voltages or on-off power surges will not damage the power transformer and related components.

AUTOMATIC RECYCLING

In case of momentary overload, the transmitter recycles automatically. Should the overload reoccur in excess of the number of times preset in the transmitter, the FM-40K will then remain off the air until reset, either locally or by remote control.

TESTING

Environmental tests, in conditions surpassing those of any location a transmitter is likely to encounter, have been imposed on the FM-40K. The transmitter is capable of operating at altitudes up to 7500 feet (2286 meters), in an ambient temperature range of -20° to $+45^{\circ}$ C (-4° to $+113^{\circ}$ F).

In addition, your FM-40K is fully tuned and operationally tested on your frequency before shipment.

REMOTE CONTROL

All connections for remote control are built

in—just connect the FM-40K to a transmitter control unit, and you are ready for remote operation. No additional equipment is required.

GENERAL

There are many other operational and convenience features incorporated into the FM-40K. These include:

PUSHBUTTON OPERATION. Daily operation of the FM-40K is simple, with on-off

functions controlled by lighted pushbuttons, which are clearly marked "Filament On-Off" and "Plate On-Off".

HIGH CAPACITY BLOWERS. (one in each 20-kilowatt amplifier). Backed up by precision air-pressure switches, these blowers provide complete protection to the IPA and PA tubes.

EASE OF MAINTENANCE. The FM-40K is designed to allow quick accessibility to all

components for easier maintenance and troubleshooting.

HANDSOME STYLING. Transmitter cabinets are attractively yet functionally styled, with double front doors on each 20-kilowatt amplifier. The finish is white, blue and black.

TYPE ACCEPTANCE. Harris' FM-40K is FCC type accepted for mono, stereo and SCA broadcasting in the 87.5 to 108 MHz band.

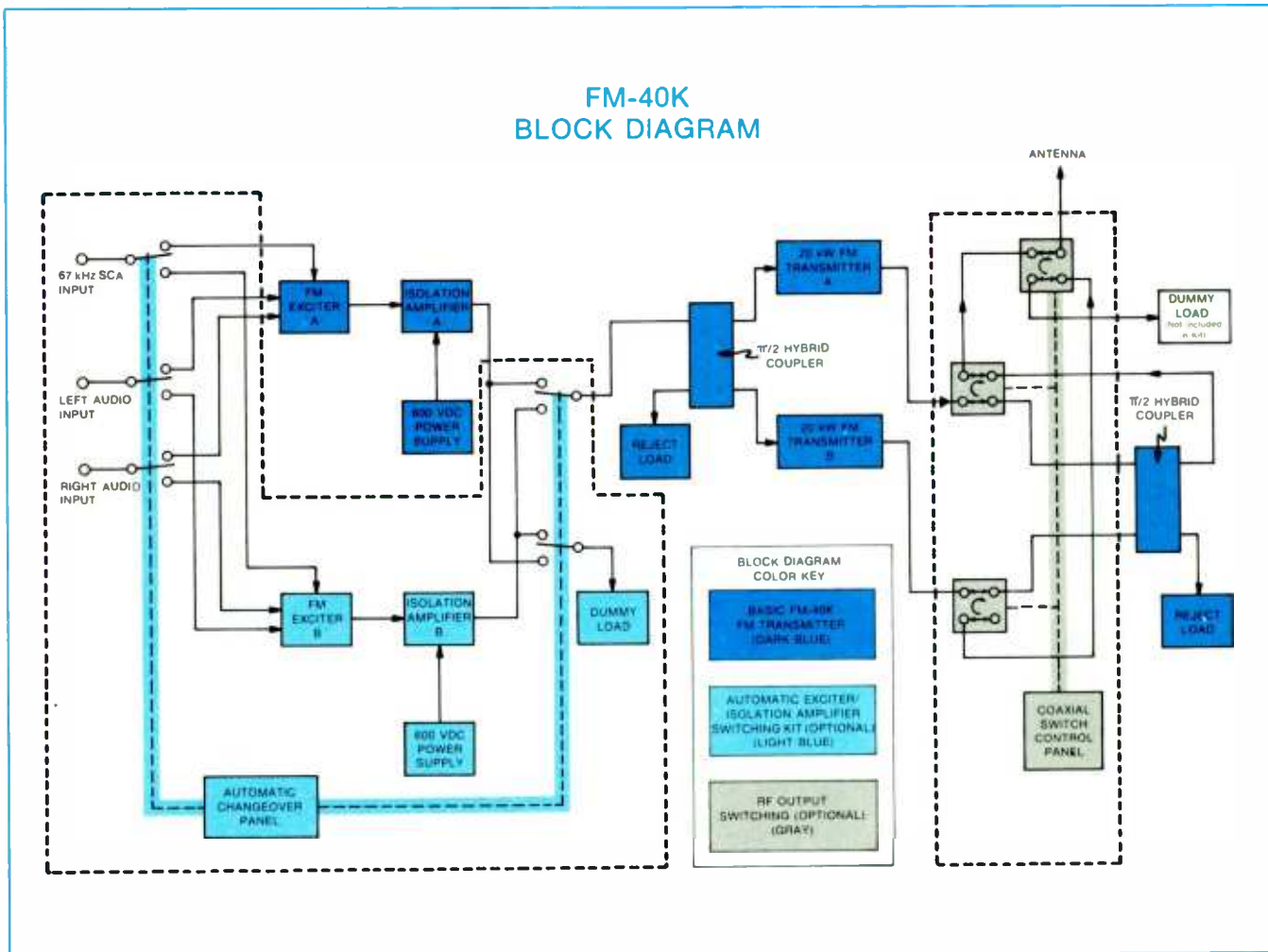

HARRIS' FM-40K FM TRANSMITTER CONFIGURATIONS

Basic Dual System

- Two FM-20K transmitters, less exciters
- One MS-15 exciter
- One isolation amplifier with power supply
- One center cabinet
- One high-power hybrid coupler (combiner) with plumbing to interconnect two transmitters
- One low-power hybrid coupler
- One 10-kilowatt reject load
- One 50-watt reject load

Automatic Exciter/Isolation Amplifier Switching Kit (Optional)

For exciter redundancy, the following ad-

ditional equipment (included in this kit) should be added to the basic system:

- One MS-15 exciter
- One isolation amplifier with power supply
- One test load for exciter
- One automatic changeover contact panel (mounts in center cabinet)

RF Output Switching (Optional)

For RF switching of the high-power output amplifiers, the following equipment (included in this kit) should be added to the basic system:

- One control panel (mounts in center cabinet)

- Three coaxial transfer switches
- One kit consisting of rigid coaxial line, elbows and flanges
- One 50-kilowatt test load required (not included in kit)

Optional Equipment For FM-40K

- Mono generator module
- Stereo generator module
- SCA generator module(s)
- VSWR overload protection for each 20-kilowatt amplifier
- Status light system for each 20-kilowatt amplifier
- 50-kilowatt air-cooled load
- 50-kilowatt water-cooled load

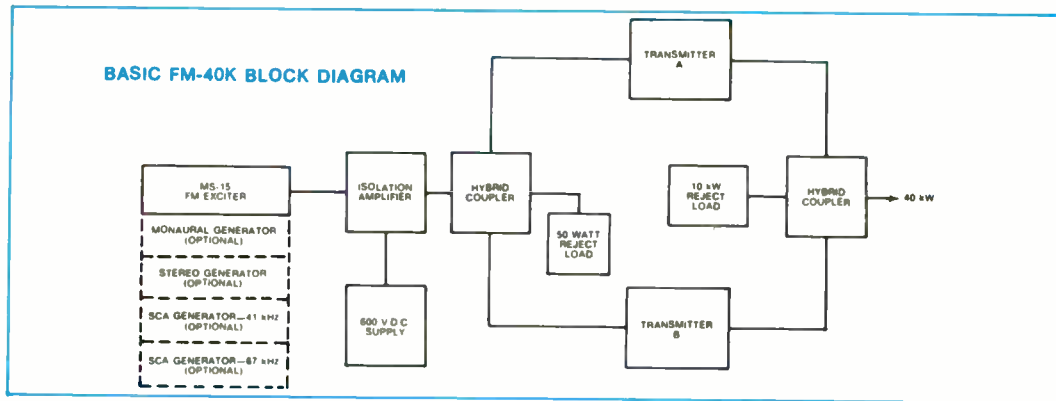

FM-40K SPECIFICATIONS

GENERAL

POWER OUTPUT: 20 kW to 40 kW.
FREQUENCY RANGE: 87.5 to 108 MHz, tuned to specified operating frequency.
RF OUTPUT IMPEDANCE: 50 ohms.
OUTPUT TERMINATION: 3/4" EIA flange.
FREQUENCY STABILITY: ± 300 Hz 0° to 45° C TCXO.
TYPE OF MODULATION: Direct Carrier Frequency Modulation.
MODULATION CAPABILITY: ± 100 kHz.
AC INPUT POWER: 208/240 V, 3-phase, 60 Hz. (50 Hz available on special order.) Power consumption: 60,000 watts (approx.). 115/230 V, 60 or 50 Hz, 150 watts for MS-15.
RF HARMONICS: Suppression meets all FCC requirements.
ALTITUDE: 7500 feet (2286 meters).
AMBIENT TEMPERATURE RANGE: -20° C to $+45^\circ$ C (-4° to $+113^\circ$ F).
MAXIMUM VSWR: 1.7 to 1.
SIZE: Transmitter: 113"W (287cm) x 78"H (198cm) x 33"D (84cm). HV power supply cabinets (2): each 30"W (76cm) x 49"H (125cm) x 30"D (76cm).
FRONT DOOR SWING: 21" (53cm).
FINISH: White, blue and black.
WEIGHT AND CUBAGE: Export: 6800 lbs. (3087 kg). Domestic: 6000 lbs. (2724 kg). 270 cubic feet (7.5 cubic meters).

MONAURAL MODE

AUDIO INPUT IMPEDANCE: 600 ohms balanced, resistive, adaptable to other impedances.
INPUT FILTER: Controlled response LPF, defeatable.
AUDIO INPUT LEVEL: $+10$ dBm ± 1 dB for 100% modulation at 400 Hz.
AUDIO FREQUENCY RESPONSE: Standard 75 microsecond FCC pre-emphasis curve ± 0.5 dB, 30-15,000 Hz. Selectable: flat, 25 or 50 microsecond pre-emphasis.
HARMONIC DISTORTION: 0.2% or less, 30-15,000 Hz.
IMD: 0.2%, 60/7000 Hz, 4:1 ratio.
FM NOISE: 68 dB below 100% modulation (ref. 400 Hz @ ± 75 kHz deviation).
AM NOISE: 50 dB below reference carrier AM modulation 100%.

STEREOPHONIC MODE

TYPE OF MODULATION: Digitally Synthesized Modulation (DSM).
AUDIO INPUT IMPEDANCE: (left and right) 600 ohms balanced, resistive. Adaptable to other impedances.
AUDIO INPUT LEVEL: (left and right) $+10$ dBm ± 1 dB for 100% modulation at 400 Hz.
AUDIO FREQUENCY RESPONSE: (left and right) Standard 75 microsecond, FCC pre-emphasis curve ± 0.5 dB 30-15,000 Hz. Selectable: flat, 25 or 50 microsecond pre-emphasis.
INPUT FILTERING: 15 kHz LPF, 45 dB rejection at 19 kHz.

OVERSHOOT PROTECTION: Dynamic transient response (DTR) filter.
AUDIO TRANSIENT RESPONSE: 2% maximum overshoot beyond steady state. Defeatable for test purposes.
HARMONIC DISTORTION: (left or right) 0.4% or less, 30-15,000 Hz.
IMD: 0.4%, 60/7000 Hz, 4:1 ratio.
FM NOISE: (left or right) 65 dB minimum below 100% modulation. Reference: 400 Hz, 75 microsecond de-emphasis, ± 75 kHz deviation.
PILOT OSCILLATOR: Crystal controlled.
PILOT STABILITY: 19 kHz ± 1 Hz, 0° to 45° C.
PILOT PHASE: Automatically controlled.
STEREO SEPARATION: 40 dB minimum 30-15,000 Hz.
CROSSTALK: (main to stereo sub-channel or stereo sub-to main channel) 45 dB below 90% modulation.
SUB CARRIER SUPPRESSION: 50 dB below 90% modulation.
76 kHz SUPPRESSION: 60 dB minimum below 100% modulation.
MODES: Stereo, mono (L + R), mono (L), mono (R). Remoteable.

SCA SPECIFICATIONS

MODULATION: Direct FM.
FREQUENCY: 41 or 67 kHz programable, any frequency between 25 and 75 kHz on special order.
FREQUENCY STABILITY: ± 500 Hz.
MODULATION CAPABILITY: ± 7.5 kHz.
AUDIO INPUT IMPEDANCE: 600 ohms balanced (AC coupled) and 2000 ohms unbalanced (DC coupled).
AUDIO INPUT LEVEL: $+10$ dBm ± 1 dB for 100% modulation at 400 Hz.
AUDIO FREQUENCY RESPONSE: 41 kHz and 67 kHz, 150 microsecond pre-emphasis ± 1 dB, standard. Selectable: flat, 50 or 75 microsecond pre-emphasis.
INPUT FILTERING: Programable LPF, 4.5 kHz standard.
DISTORTION: Less than 1%, 30-5000 Hz. ± 5 kHz deviation.
FM NOISE: (main channel not modulated) 55 dB minimum (ref: 100% = ± 5 kHz deviation at 400 Hz).
CROSSTALK: (SCA to main or stereo sub-channel): -60 dB or better.
CROSSTALK: (main or stereo sub-channel to SCA): 50 dB below ± 5 kHz deviation of SCA, with mono or stereo channels modulated by frequencies 30-15,000 Hz, SCA demodulated with 150 microsecond de-emphasis.
CROSSTALK: SCA to SCA (41 kHz/67 kHz) 50 dB demodulated with 150 microsecond de-emphasis.
AUTOMATIC MUTE LEVEL: Variable from 0 to -30 dBm.
MUTE DELAY: Adjustable 0.5 to 20 seconds.
INJECTION LEVEL: 1% to 30% of composite. Adjustable.

WIDEBAND MODE

INPUT IMPEDANCE: Greater than 5000 ohms resistive, unbalanced.
INPUT LEVEL: 1.0 VRMS nominal for ± 75 kHz deviation.
AMPLITUDE RESPONSE: ± 0.25 dB, 30 Hz to 75 kHz.
PHASE LINEARITY: $\pm 2^\circ$, 30 Hz to 75 kHz.

SPECIFICATIONS SUBJECT TO CHANGE WITHOUT NOTICE.

ORDERING INFORMATION

FM-40K, 40-kilowatt FM transmitter, basic system, for wideband operation, 60 Hz	994-8053-001
Automatic exciter/isolation amplifier switching kit	994-6876-001
RF output switching package	994-6877-001
Monaural generator (add for mono operation)	994-8019-001
DSM stereo generator with DTR (add for stereo operation)	994-8020-001
SCA generator (add for SCA operation, specify 41 or 67 kHz)	994-7992-001
VSWR interlock unit (two required for FM-40K)	994-7004-001
Status light system (two required for FM-40K)	994-7108-001
50-kilowatt air-cooled test load	700-0317-000
50-kilowatt water-cooled test load	700-0239-000



HARRIS

FM-25K

25-Kilowatt
FM Broadcast
Transmitter

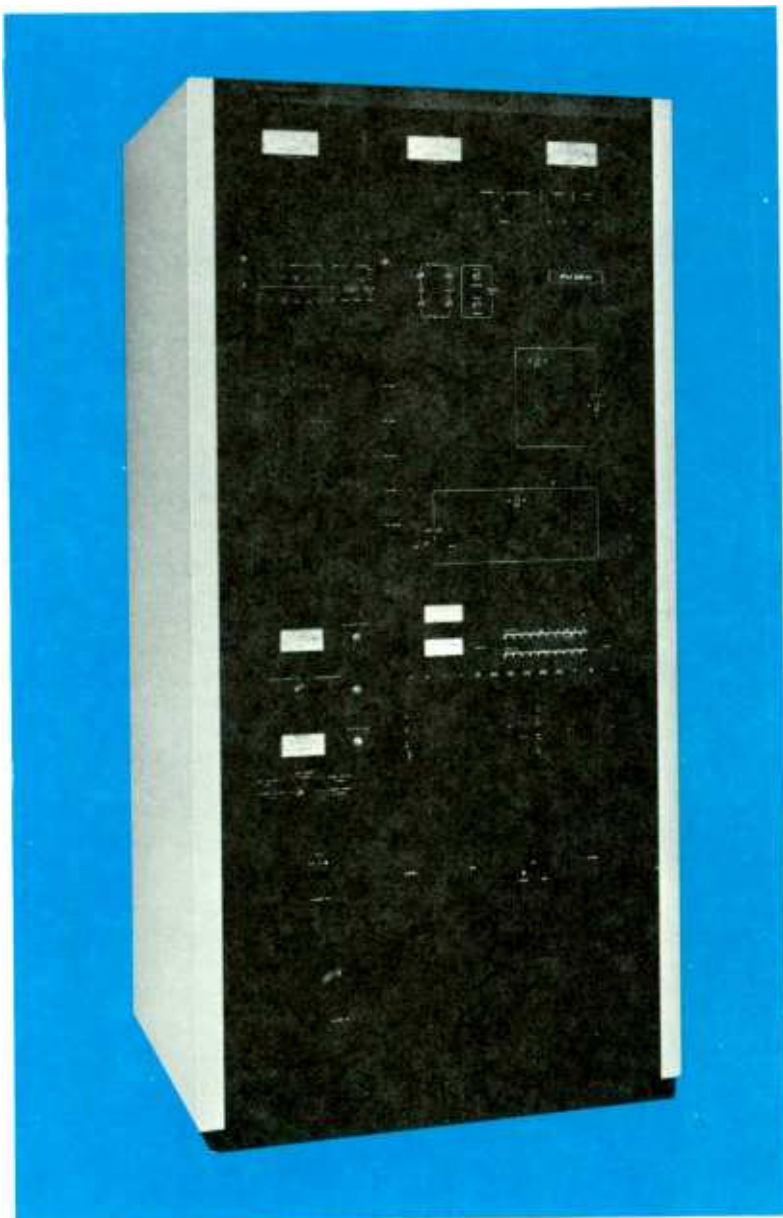

- First one-tube high-power FM transmitter
- High efficiency, low operating cost
- Solid-state, redundant IPA
- Wide RF bandwidth, minimum tunable components
- Driven by the most advanced FM exciter in the world—MS-15
- Patented DSM stereo generator . . . stereo separation 40 dB minimum, 50 dB typical
- DTR filter technique limits overshoot to 2% or less
- Solid-state control logic
- Automatic power control standard

Harris' technology has combined advances in both tube and transistor designs, to bring you a major step forward in high-power FM transmitters. Transistors are now available which provide 50 watts of RF power at reasonable gain and low junction temperatures. By combining several of these transistors in wideband RF circuits, enough power can be generated to drive an advanced high-gain Eimac tetrode tube, the 8990. This tube, when grid driven in a grounded cathode, quarter-wave cavity, can produce 25 kilowatts with 350 watts of drive at nearly 80% plate efficiency!

The FM-25K, twenty-five kilowatt FM transmitter reflects Harris' design philosophy that FM transmitters should deliver RF power efficiently, should not limit exciter performance, and should integrate dependable solid-state control logic. In the FM-25K, these features are teamed with efficient, single-tube design, and with the world's most advanced exciter—the MS-15.

The FM-25K was designed for applications with tower limitations or specific coverage requirements. The higher RF power output reduces the number of antenna bays required for a given ERP; and fewer bays mean a reduction in windloading and mounting area, so that tower size and/or height may be reduced. Also, fewer antenna bays, with less gain, can mean improved close-in coverage and the elimination of null fills.

SINGLE TUBE DESIGN. The FM-25K is the first high-power FM transmitter to utilize a single-tube design. A high-gain, highly efficient 8990 tetrode is the only tube in the entire transmitter, and is used as the final power amplifier. The tube uses a

Harris' FM-25K... high efficiency...

wavy fin radiator which provides exceptional cooling at reduced air requirements, for quiet operation. The quarter-wave PA cavity design eliminates troublesome sliding contacts for tuning, and assures wide RF bandwidth. This results in a signal path that is transparent to the MS-15 exciter.

SOLID-STATE IPA. Five solid-state power amplifier modules (2 amplifiers per module) are combined to produce 350 watts of drive power, with plenty of reserve. One module functions as the IPA driver, and the other four as driver power amplifiers. All of these modules are identical, so that in case the IPA driver should fail, one of the power amplifier modules may be inserted in its place. Loss of one of the four driver amplifier modules will not result in an off-air condition, as these solid-state amplifiers are isolated from each other. All five solid-state amplifier modules are broadbanded, and require no individual tuning over the entire 88-108 MHz FM band. The solid-state, modular concept affords back-up capability for greatly improved reliability, and reduces overall transmitter tuning requirements.

LOW OPERATING COST. With today's mounting energy costs, transmitter efficiency must be a major consideration in any purchase. 77% efficiency in the final power amplifier, high efficiency in all amplifier circuits, and conservatively rated components result in comparatively low power consumption and low operating stress on heat generating components in the FM-25K. This adds up to very impressive savings in operating and maintenance costs.

AUTOMATIC POWER CONTROL. The FM-25K automatically monitors power output, and maintains the output at the desired level. This standard feature insures against out-of-tolerance power conditions. Furthermore, the power set point can be remotely adjusted independently of the limit points to allow operator control of power output. During maintenance periods, the automatic power control may be switched off.

VSWR PROTECTION. VSWR protection is mandatory in any high-power transmitter—therefore, Harris has incorporated this as a standard feature in the FM-25K. A high VSWR condition will cause the transmitter to recycle... if three overloads occur within a given time period, the

transmitter will shut down until manually restarted. The transmitter may also be programmed for single VSWR overload shutdown.

CONTROL CIRCUITRY. The FM-25K is controlled by solid-state logic circuitry. The logic circuitry not only controls basic On/Off functions, but also monitors critical stages for overload conditions. Should an overload occur, the transmitter will recycle automatically, according to the number of times pre-set (one or three).

The control logic used in the FM-25K interfaces directly with most remote control systems, eliminating the need for an additional remote control interface. The control signals are momentary low current contacts to ground. The transmitter output parameters are buffered, and all status indicators are remoted.

METERING AND VISUAL AIDS. Major functions, including RF output, VSWR and PA parameters are displayed on easy-to-read four-inch meters. Low-level parameters are displayed on a multimeter, and IPA RF output and reflected power are indicated on another meter. Filament voltage is measured by a true RMS circuit.

The FM-25K provides a variety of indicators as trouble shooting aids and quick references. These include four illuminated On/Off pushbuttons and 26 LED's not including those on the MS-15 exciter.

HV POWER SUPPLY. The high voltage power supply is housed in a separate cabinet, and provides the plate and screen supplies. The conservatively-rated three-phase plate supply uses silicon rectifiers with AC line transient protection.

COMPACT SIZE. The trim PA cabinet can fit as a replacement for all older 20- to 25-kilowatt FM transmitters. The cabinet is only 35 inches wide, 72 inches high and 31 inches deep. Additionally, the HV power supply may be located in any convenient spot remote from the PA cabinet.

GENERAL. There are many other operational and convenience features incorporated into the FM-25K. These include:

Line Loss Protection—
Built-in protection against total AC failure and loss of

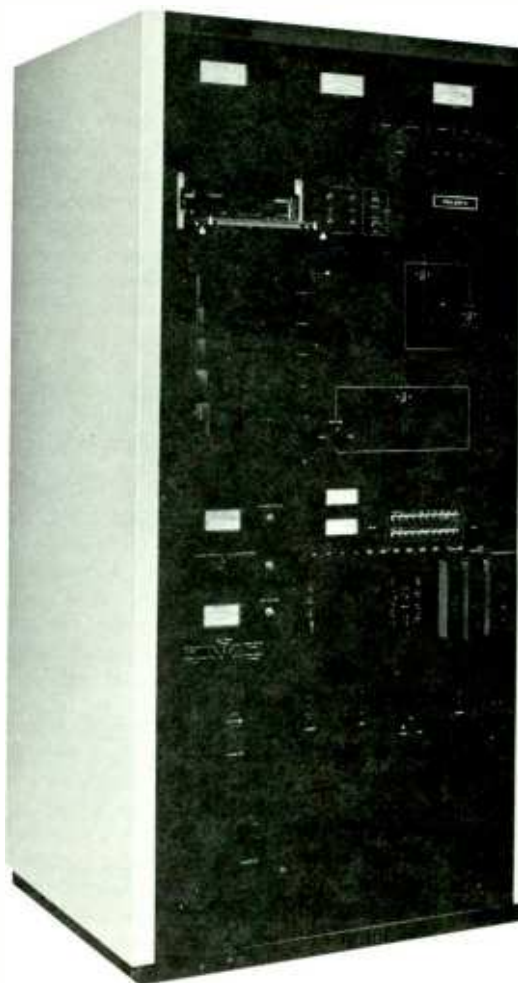

only one tube ... wide RF bandwidth

phase is provided. The FM-25K will restart automatically following a total power failure, while loss of a single phase will shut down the transmitter.

High Altitude Rating—A high-capacity, direct-drive blower delivers sufficient air to cool the transmitter at altitudes up to 10,000 feet (3048 meters).

Additional Protection—Four magnetic circuit breakers are utilized to protect the blower motor, the filament supply, the IPA supply and the bias supply. A wide-ranging interlock system and a drop solenoid system quickly discharge power supplies to safe levels.

ATS Compatibility—The simple control logic interface and full metering in the FM-25K permit ATS operation.

MS-15 EXCITER. The solid-state MS-15 exciter employs Digitally Synthesized Modulation (DSM), overshoot compensation, and other Harris exclusive design techniques, to give you an FM sound that is noticeably cleaner, noticeably louder than any competitive signal.

The DSM stereo generator is a Harris development which eliminates the tradeoff that exists between switching type stereo generators (poor separation at high frequencies) and balanced modulator types of stereo generators (poor harmonic rejection and SCA crosstalk). The DSM stereo generator is capable of both 50 dB separation (typical) through 15 kHz and an exceptionally clean baseband, promoting minimal interaction between stereo and SCA service. Also, pilot phase is automatically controlled so that high separation can be maintained under varying operating conditions.

A Dynamic Transient Response (DTR) filter has been developed by Harris for FM stereo, which holds overshoot to 2% or less on any program material processed by any limiter. As a result, a 2 to 6 dB increase in loudness can be achieved without degradation of audio quality. Controlled

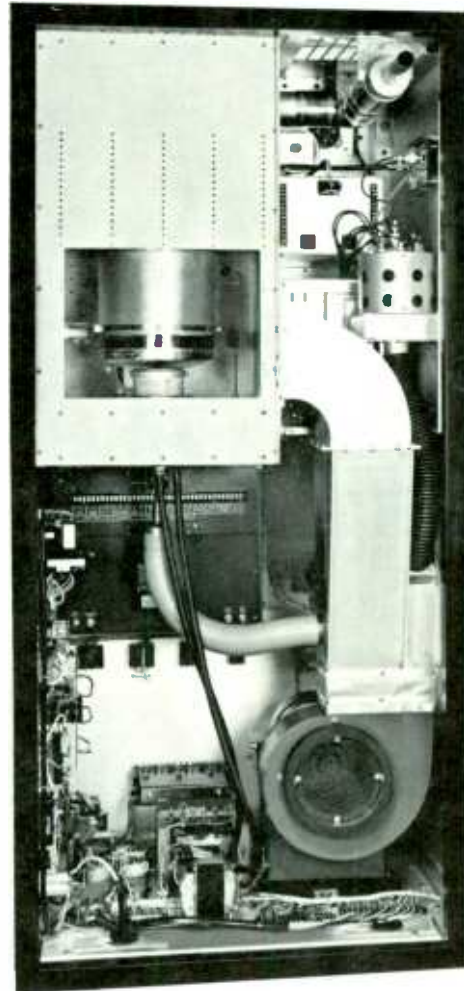

transient response, high stereo separation, low crosstalk and low intermodulation distortion are all maintained with increased loudness. For monaural stations wishing to protect 41 and/or 67 kHz SCA channels, a defeatable linear phase lowpass filter is provided for optimal linear control of overshoot.

The MS-15 is available for wideband, mono or stereo operation, with or without SCA. The modular construction of the MS-15 allows you to change the mode of operation or to add SCA at any time, by simply plugging in the appropriate module(s).



HARRIS

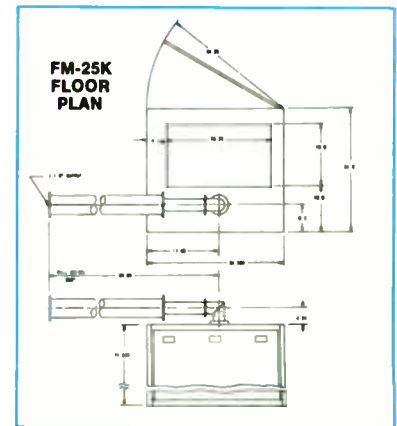
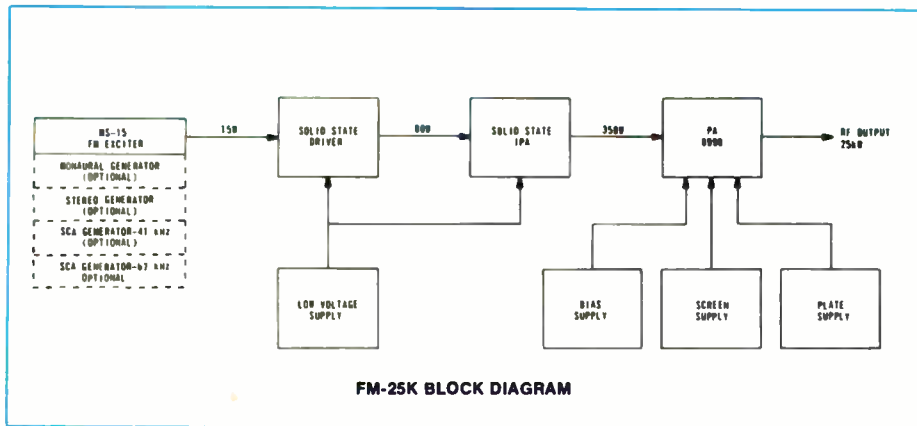

FM-25K SPECIFICATIONS

GENERAL

POWER OUTPUT: 10 kW to 25 kW.
FREQUENCY RANGE: 87.5 to 108 MHz, tuned to specified operating frequency. Exciter programmable in 50 kHz increments.
RF OUTPUT IMPEDANCE: 50 ohms.
OUTPUT TERMINATION: 3 1/2" EIA flange.
FREQUENCY STABILITY: ±300 Hz 0° to 45°C TCXO.
TYPE OF MODULATION: Direct Carrier Frequency Modulation.
MODULATION CAPABILITY: ±100 kHz.
AC INPUT POWER: 208/240 V, 3-phase, 50/60 Hz and 360/415 V, 3 phase, 50/60 Hz, 4-wire. Power consumption: 40kW typical.
RF HARMONICS: Suppression meets all FCC requirements.
ALTITUDE: 10,000 feet (3048 meters).
AMBIENT TEMPERATURE RANGE: -20°C to +50°C. Maximum temperature 50°C @ sea level, decreasing 2°C per 1000 feet (305 meters) to 30°C maximum at 10,000 feet (3048 meters).
MAXIMUM VSWR: 1.7 to 1.
SIZE: Transmitter cabinet, 34.6" W (87.8 cm) x 71.7" H (182.1 cm) x 31.0" D (78.7 cm). HV power supply cabinet: 48.0" W (121.9 cm) x 60.2" H (152.9 cm) x 24.2" D (61.5 cm).
FINISH: White, blue and black.
WEIGHT AND CUBAGE: (Estimated) Export: 3000 lbs. (1361 kg). Domestic: 2700 lbs. (1225 kg). Cubage: 150 cubic feet.

MONAURAL MODE

AUDIO INPUT IMPEDANCE: 600 ohms balanced, resistive, adaptable to other impedances.
INPUT FILTER: Controlled response LPF, defeatable.
AUDIO INPUT LEVEL: +10 dBm ±1 dB for 100% modulation at 400 Hz.
AUDIO FREQUENCY RESPONSE: Standard 75 microsecond FCC pre-emphasis curve ±0.5 dB, 30-15,000 Hz. Selectable: flat, 25 or 50 microsecond pre-emphasis.
HARMONIC DISTORTION: 0.2% or less, 30-15,000 Hz.
IMD: 0.2%, 60/7000 Hz, 4:1 ratio.
FM NOISE: 68 dB below 100% modulation (ref. 400 Hz @ ±75 kHz deviation).
AM NOISE: 55 dB below reference carrier AM modulation 100%.

STEREOPHONIC MODE

TYPE OF MODULATION: Digitally Synthesized Modulation (DSM).
AUDIO INPUT IMPEDANCE: (left and right) 600 ohms balanced, resistive. Adaptable to other impedances.
AUDIO INPUT LEVEL: (left and right) +10 dBm ±1 dB for 100% modulation at 400 Hz.
AUDIO FREQUENCY RESPONSE: (left and right) Standard 75 microsecond, FCC pre-emphasis curve ±0.5 dB 30-15,000 Hz. Selectable: flat, 25 or 50 microsecond pre-emphasis.
INPUT FILTERING: 15 kHz LPF, 45 dB rejection at 19 kHz.
OVERSHOOT PROTECTION: Dynamic transient response (DTR) filter.
AUDIO TRANSIENT RESPONSE: 2% maximum overshoot beyond steady state. Defeatable for test purposes.

HARMONIC DISTORTION: (left or right) 0.4% or less, 30-15,000 Hz.
IMD: 0.4%, 60/7000 Hz, 4:1 ratio.
FM NOISE: (left or right) 65 dB minimum below 100% modulation. Reference: 400 Hz, 75 microsecond de-emphasis, ±75 kHz deviation.
PILOT OSCILLATOR: Crystal controlled.
PILOT STABILITY: 19 kHz ±1 Hz, 0° to 45°C.
PILOT PHASE: Automatically controlled.
STEREO SEPARATION: 40 dB minimum 30-15,000 Hz, 50 dB typical.
CROSSTALK: (main to stereo sub-channel or stereo sub-to main channel) 45 dB below 90% modulation.
SUB CARRIER SUPPRESSION: 50 dB below 90% modulation.
76 kHz SUPPRESSION: 60 dB minimum below 100% modulation.
MODES: Stereo, mono (L + R), mono (L), mono (R). Remoteable.

SCA SPECIFICATIONS

MODULATION: Direct FM.
FREQUENCY: 41 or 67 kHz programmable, any frequency between 25 and 75 kHz on special order.
FREQUENCY STABILITY: ±500 Hz.
MODULATION CAPABILITY: ±7.5 kHz.
AUDIO INPUT IMPEDANCE: 600 ohms balanced (AC coupled) and 2000 ohms unbalanced (DC coupled).
AUDIO INPUT LEVEL: +10 dBm ±1 dB for 100% modulation at 400 Hz.
AUDIO FREQUENCY RESPONSE: 41 kHz and 67 kHz, 150 microsecond pre-emphasis ±1 dB, standard. Selectable: flat, 50 or 75 microsecond pre-emphasis.
INPUT FILTERING: Programmable LPF, 4.5 kHz standard.
DISTORTION: Less than 1%, 30-4500 Hz. ±5 kHz deviation.
FM NOISE: (main channel not modulated) 55 dB minimum (ref: 100% = ±5 kHz deviation at 400 Hz).
CROSSTALK: (SCA to main or stereo sub-channel): -60 dB or better.
CROSSTALK: (main or stereo sub-channel to SCA): 50 dB below ±5 kHz deviation of SCA, with mono or stereo channels modulated by frequencies 30-15,000 Hz, SCA demodulated with 150 microsecond de-emphasis.
CROSSTALK: SCA to SCA (41 kHz/67 kHz) 50 dB demodulated with 150 microsecond de-emphasis.
AUTOMATIC MUTE LEVEL: Variable from 0 to -30 dBm.
MUTE DELAY: Adjustable 0.5 to 20 seconds.
INJECTION LEVEL: 1% to 30% of composite. Adjustable.

WIDEBAND MODE

INPUT IMPEDANCE: Greater than 5000 ohms resistive, unbalanced.
INPUT LEVEL: 1.0 VRMS nominal for ±75 kHz deviation.
AMPLITUDE RESPONSE: ±0.25 dB, 30 Hz to 75 kHz.
PHASE LINEARITY: ±2°, 30 Hz to 75 kHz.

SPECIFICATIONS SUBJECT TO CHANGE WITHOUT NOTICE.

ORDERING INFORMATION

FM-25K, 25,000 watt FM broadcast transmitter with MS-15 exciter, for wideband operation, 50/60 Hz (specify 50 or 60 Hz).....	994-8258-001
Spare tube	374-0151-000
Mono generator (add for mono operation)	994-8019-001
DSM stereo generator with DTR (add for stereo operation)	994-8020-001
SCA generator (add for SCA operation, specify 41 or 67 kHz).....	994-7992-001



HARRIS

FM-20K

20-Kilowatt
FM
Broadcast
Transmitter

- MS-15 Exciter - Ultra linear modulated oscillator for minimum distortion and maximum signal clarity
- Digitally Synthesized Modulation - DSM stereo generator provides high stereo separation under all programming conditions!
- Dynamic Transient Response Filter - Permits 2 to 6 dB increase in loudness ... yields dominant signal without overmodulating
- 80% Final PA Efficiency - Yields long tube life, low power consumption, for direct operating cost savings
- VSWR Protection - Provides fault protection to your costly antenna and transmission line equipment
- Convenient Operation - Full metering, status lights and remote control termination are just a few of the standard features which minimize installation, maintenance and time



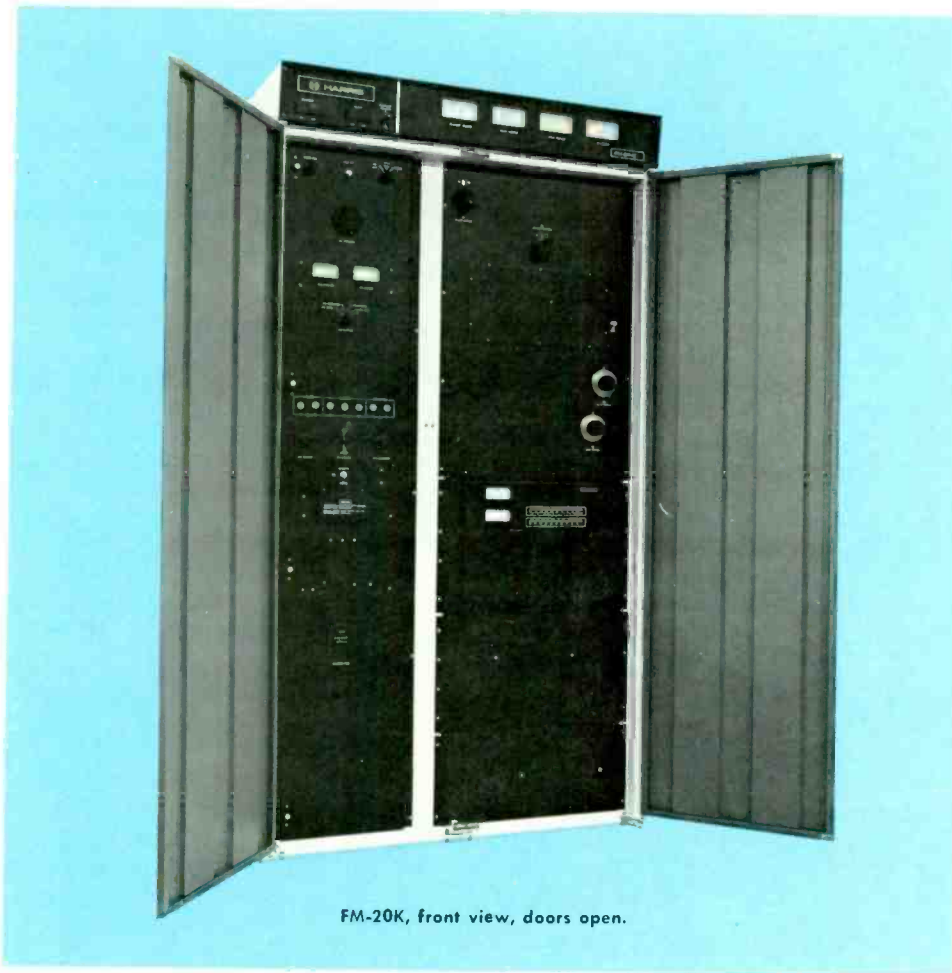

FM-20K, front view, doors open.

The FM-20K employs Harris' exclusive, advanced-design MS-15 solid-state exciter, with Digitally Synthesized Modulation (DSM), to provide the very finest stereo signal available. Technical specifications are exceptional compared to other 20 kilowatt FM transmitters on the market. And DSM with overshoot compensation allows a 2 to 6 dB increase in loudness with no degradation of audio quality. With Harris' FM-20K you not only get the cleanest sound in town—you get the loudest!

LOW OPERATING COST. 80% efficiency in the final amplifier, plus high efficiency in all amplifier circuits, plus conservatively rated components combine to give the FM-20K the lowest operating cost of any transmitter in its power range. As amplifier tubes are operated at only a fraction of their actual rating, maximum service life is assured. You save both on power bills and on tube costs.

THREE TUBES. Only three tubes (two tube types) are used in the FM-20K. The MS-15 drives the intermediate power amplifier, consisting of two parallel 4CX250B's. The final single-ended power amplifier is a 4CX15000A ceramic tetrode, which provides excellent perform-

ance, and runs at only one-third its dissipation capability.

"VARI-LINE" SILVER PLATED TANK. Vari-Line is an advanced, Harris-developed method of tuning a single-ended FM amplifier for optimum output efficiency. A portion of a parallel tubular 2 $\frac{3}{8}$ -inch copper transmission line (silver plated for efficient RF service) is made variable in order to inductively tune the line to operating frequency.

With Vari-Line tuning, greater reliability is possible. Mica capacitors are not used in the tank circuit. This reduces the complexity of sliding contacts and consequent maintenance problems.

PLUG-IN MONO, STEREO AND SCA GENERATORS. The FM-20K may be equipped for mono or stereo operation, with or without SCA. The design versatility of the exciter allows you to order for mono operation originally, then add stereo and/or SCA at a later date by plugging the appropriate module(s) into the exciter. Since the SCA generators have spectrally pure filtered outputs, 41 and 67 kHz SCA channels may be operated simultaneously, while in the mono mode, without harmonic interference.

DUAL HV SILICON POWER SUPPLY. Two separate three-phase power sup-

plies are used for the FM-20K—both featuring "avalanche" silicon rectifiers for greatest reliability and protection against transient voltages or on-off power surges.

One HV power supply—for PA plate voltage—is housed in a separate enclosure, while the supply powering the IPA plate and screen circuit, and the PA screen, is housed in the main transmitter cabinet.

AUTOMATIC RECYCLING. In case of momentary overload, the transmitter recycles automatically. Should the overload reoccur in excess of the desired number of times preset in the transmitter, the FM-20K will then remain off the air until it is reset, either locally or by remote control.

TESTING. Environmental tests, in conditions surpassing those of any location a transmitter is likely to encounter, have been imposed on the FM-20K. The transmitter is capable of operating at altitudes to 7500 feet, in an ambient temperature range of -20° to $+45^{\circ}$ C.

In addition, your FM-20K is fully tuned and operationally tested on your frequency before shipment.

REMOTE CONTROL. All remote control provisions are built-in. No additional transmitter kits or options are needed.

FULL METERING. Eight easy-to-read meters, including a multimeter, provide full monitoring of the seventeen parameters of the operating tubes and exciter. There is also a directional coupler which measures forward power and VSWR, and an elapsed time meter.

GENERAL. There are many other operational and convenience features incorporated into the FM-20K. These include: Pushbutton Operation — On-off functions are controlled by lighted pushbuttons at the top left of the transmitter. These are clearly marked "Filament On-Off", "Plate On-Off".

High-Capacity Blower — backed up by a precision air-pressure switch gives complete protection to the IPA and PA tubes.

Straightforward Design — allows easy accessibility to all components.

Front Panel Test Points — permit fast checking of exciter circuit conditions.

Handsome Styling — the transmitter cabinet is attractively yet functionally styled, with double front doors. The finish is white and blue, with black meter panel.

FCC Type Acceptance — the FM-20K is FCC type accepted for mono or stereo broadcasting in the 87.5 to 108 MHz FM band.

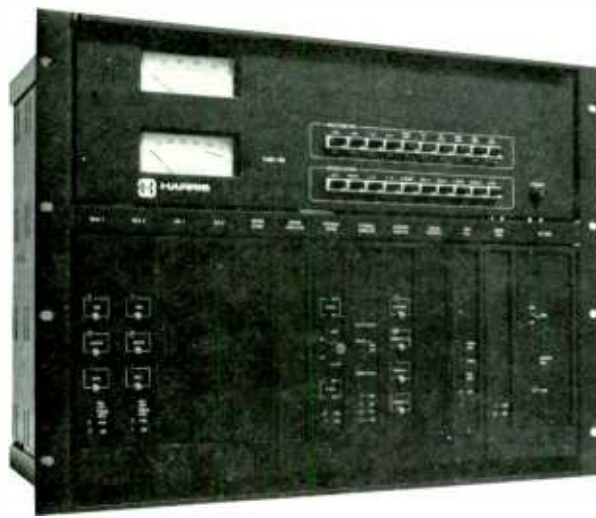

HARRIS' MS-15...THE MOST ADVANCED FM EXCITER IN THE INDUSTRY

The solid-state MS-15 exciter employs Digitally Synthesized Modulation, overshoot compensation, and other exclusive design techniques, to give you an FM sound that is noticeably cleaner, noticeably louder than any competitive signal. The exciter is available for mono or stereo operation, with or without SCA. The modular construction of the MS-15 allows you to change the mode of operation, or to add SCA, at any time, by simply plugging in the appropriate module(s).

FCC approval of a system for quadrasonic FM will not obsolete the MS-15. Module positions exist which are ready to accept a quad generator.

DIGITALLY SYNTHESIZED MODULATION. The DSM stereo generator is a new development which eliminates the tradeoff that exists between switching type and balanced modulator types of stereo generators—poor separation at high frequencies in the former or poor harmonic rejection and SCA crosstalk in the latter. The DSM stereo generator is capable of both 50 dB separation (typical) through 15 kHz and an exceptionally clean baseband, promoting minimal interaction between stereo and SCA service. Also, pilot phase is automatically controlled so that high separation can be maintained under varying operating conditions.

OVERSHOOT COMPENSATION. A Dynamic Transient Response (DTR) filter has been developed by Harris for FM stereo, with overshoot no greater than 2% on any program material processed by any limiter. As a result, from 2 to 6 dB increased loudness can be achieved without degradation of audio quality. Controlled transient response, high stereo separation, low crosstalk, and low intermodulation distortion are all maintained with increased loudness. For monaural

stations wishing to protect 41 and/or 67 kHz SCA channels, a defeatable linear phase lowpass filter is provided for optimal linear control of overshoot.

COMPATIBILITY. The MS-15 exciter is mechanically and electrically compatible with the Harris TE-3 exciter. Mountings are in the same location and use the same hardware.

RF output power is 15 watts into 50 ohms, continuously adjustable to 3 watts by one control. A directional coupler samples and meters forward and reflected power, with remote metering capability. A harmonic filter is placed at the RF module output, reducing harmonics to a low level. The balanced 600 ohm audio input is transformerless to give maximum common mode rejection and excellent response. Inputs will withstand high transients or steady state voltages above or below ground reference.

The basic exciter audio response is wideband and flat, and can be used directly with a studio-transmitter link. The exciter is self-contained, including the power supply.

OTHER FEATURES. The Harris MS-15 exciter can be quickly and easily programmed to any carrier frequency in the 87.5 to 108 MHz band in 50 kHz increments. The RF output network is broadband and requires no tuning. Carrier frequencies are generated through a digital synthesizer which is locked to a 10 MHz TCXO high stability frequency standard. The TCXO has improved crystal aging characteristics and does not require an oven. The synthesizer also provides outputs at 2.5, 5, 10, 15, 20 and 25 MHz for easy frequency comparison to the National Bureau of Standards WWV transmissions.

Pre-emphasis is selectable to 75, 50, 25 or 0 microseconds in either monophonic or stereophonic operation.

Remote control capability includes switching between stereo and mono, and selection of left, right, or left-plus-right inputs for monophonic operation.

SCA OPERATION. SCA operation is added to the exciter through a plug-in module. It is available with either stereo or mono operation; up to two channels can be added to mono exciters, or a single SCA used with stereo. Any channel between 25 kHz and 75 kHz can be used, although 41 kHz and 67 kHz are normally provided. Either frequency is selectable on the SCA channel card.

Pre-emphasis is selectable to 150, 75, 50 or 0 microseconds. The input audio is applied to a programmable lowpass filter, and the output of the SCA generator filtered so that 150 microseconds pre-emphasis can be used with no degradation of SCA to main channel crosstalk.

Each SCA module has a pair of audio inputs, one AC coupled for audio, and the other DC coupled for data and video transmission.

The subcarrier level is adjustable to provide from 1% to 30% composite baseband SCA injection. When an SCA subcarrier is turned on or off, an automatic composite level switcher noiselessly compensates for the change in baseband injection level. 100% peak modulation is maintained independent of SCA status.

EASE OF MAINTENANCE. The entire exciter is modular for ease of troubleshooting and maintenance. An extender card is provided to allow easy servicing. Extensive metering is provided, and LED status lights on the modules indicate various performance features.

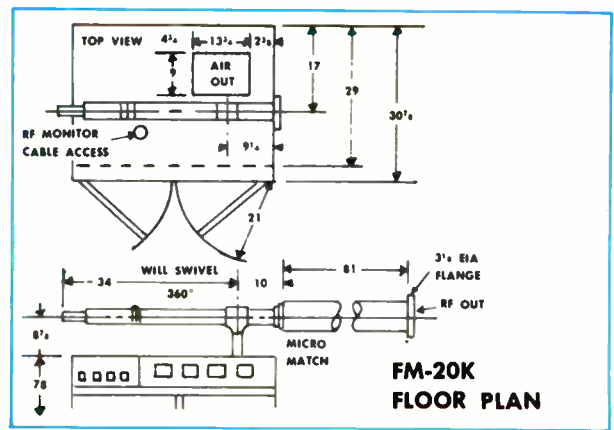
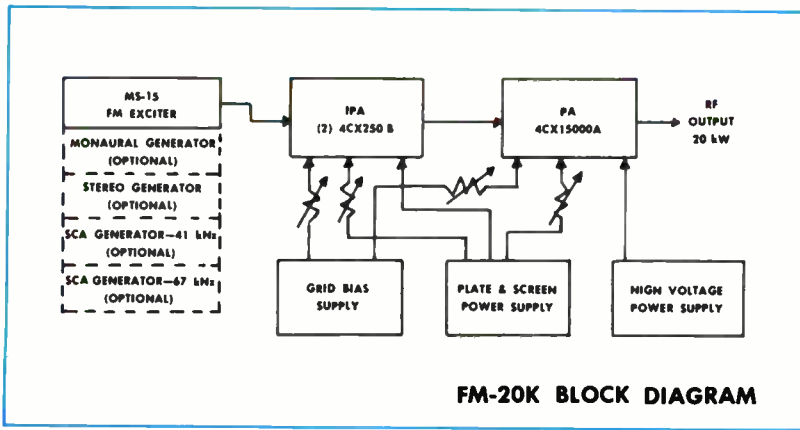

FM-20K SPECIFICATIONS

GENERAL

POWER OUTPUT: 10 kW to 20 kW (type accepted to 21.5 kW).
FREQUENCY RANGE: 87.5 to 108 MHz, tuned to specified operating frequency.
RF OUTPUT IMPEDANCE: 50 ohms.
OUTPUT TERMINATION: 3/8" EIA flange.
FREQUENCY STABILITY: ± 300 Hz 0° to 45° C TCXO.
TYPE OF MODULATION: Direct Carrier Frequency Modulation.
MODULATION CAPABILITY: ± 100 kHz.
AC INPUT POWER: 208/240 V, 3-phase, 60 Hz. (50 Hz available on special order.) Power consumption: 30,000 watts (approx.). 115/230 V, 60 or 50 Hz, 150 watts for MS-15.
RF HARMONICS: Suppression meets all FCC requirements.
POWER SUPPLY RECTIFIERS: Silicon.
ALTITUDE: 7500 feet.
AMBIENT TEMPERATURE RANGE: -20° C to $+45^\circ$ C.
MAXIMUM VSWR: 1.7 to 1.
SIZE: Transmitter cabinet, 42"W (107cm) x 78"H (198cm) x 33"D (84cm). HV power supply cabinet, 30"W (76cm) x 49"H (125cm) x 30"D (76cm).
FRONT DOOR SWING: 21" (53cm).
FINISH: White, blue and black.
WEIGHT AND CUBAGE: Export: 2800 lbs. (1270 kg). Domestic: 2300 lbs. (1043 kg). 141 cubic feet.

MONAURAL MODE

AUDIO INPUT IMPEDANCE: 600 ohms balanced, resistive, adaptable to other impedances.
INPUT FILTER: Controlled response LPF, defeatable.
AUDIO INPUT LEVEL: $+10$ dBm ± 1 dB for 100% modulation at 400 Hz.
AUDIO FREQUENCY RESPONSE: Standard 75 microsecond FCC pre-emphasis curve ± 0.5 dB, 30-15,000 Hz. Selectable: flat, 25 or 50 microsecond pre-emphasis.
HARMONIC DISTORTION: 0.2% or less, 30-15,000 Hz.
IMD: 0.2%, 60/7000 Hz, 4:1 ratio.
FM NOISE: 68 dB below 100% modulation (ref. 400 Hz @ ± 75 kHz deviation).
AM NOISE: 50 dB below reference carrier AM modulation 100%.

STEREOPHONIC MODE

TYPE OF MODULATION: Digitally Synthesized Modulation (DSM).
AUDIO INPUT IMPEDANCE: (left and right) 600 ohms balanced, resistive. Adaptable to other impedances.
AUDIO INPUT LEVEL: (left and right) $+10$ dBm ± 1 dB for 100% modulation at 400 Hz.
AUDIO FREQUENCY RESPONSE: (left and right) Standard 75 microsecond, FCC pre-emphasis curve ± 0.5 dB 30-15,000 Hz. Selectable: flat, 25 or 50 microsecond pre-emphasis.
INPUT FILTERING: 15 kHz LPF, 45 dB rejection at 19 kHz.

OVERSHOOT PROTECTION: Dynamic transient response (DTR) filter.
AUDIO TRANSIENT RESPONSE: 2% maximum overshoot beyond steady state. Defeatable for test purposes.
HARMONIC DISTORTION: (left or right) 0.4% or less, 30-15,000 Hz.
IMD: 0.4%, 60/7000 Hz, 4:1 ratio.
FM NOISE: (left or right) 65 dB minimum below 100% modulation. Reference: 400 Hz, 75 microsecond de-emphasis, ± 75 kHz deviation.
PILOT OSCILLATOR: Crystal controlled.
PILOT STABILITY: 19 kHz ± 1 Hz, 0° to 45° C.
PILOT PHASE: Automatically controlled.
STEREO SEPARATION: 40 dB minimum 30-15,000 Hz.
CROSSTALK: (main to stereo sub-channel or stereo sub-to main channel) 45 dB below 90% modulation.
SUB CARRIER SUPPRESSION: 50 dB below 90% modulation.
76 kHz SUPPRESSION: 60 dB minimum below 100% modulation.
MODES: Stereo, mono (L + R), mono (L), mono (R). Remoteable.

SCA SPECIFICATIONS

MODULATION: Direct FM.
FREQUENCY: 41 or 67 kHz programable, any frequency between 25 and 75 kHz on special order.
FREQUENCY STABILITY: ± 500 Hz.
MODULATION CAPABILITY: ± 7.5 kHz.
AUDIO INPUT IMPEDANCE: 600 ohms balanced (AC coupled) and 2000 ohms unbalanced (DC coupled).
AUDIO INPUT LEVEL: $+10$ dBm ± 1 dB for 100% modulation at 400 Hz.
AUDIO FREQUENCY RESPONSE: 41 kHz and 67 kHz, 150 microsecond pre-emphasis ± 1 dB, standard. Selectable: flat, 50 or 75 microsecond pre-emphasis.
INPUT FILTERING: Programable LPF, 4.5 kHz standard.
DISTORTION: Less than 1%, 30-5000 Hz. ± 5 kHz deviation.
FM NOISE: (main channel not modulated) 55 dB minimum (ref: 100% = ± 5 kHz deviation at 400 Hz).
CROSSTALK: (SCA to main or stereo sub-channel): -60 dB or better.
CROSSTALK: (main or stereo sub-channel to SCA): 50 dB below ± 5 kHz deviation of SCA, with mono or stereo channels modulated by frequencies 30-15,000 Hz, SCA demodulated with 150 microsecond de-emphasis.
CROSSTALK: SCA to SCA (41 kHz/67 kHz) 50 dB demodulated with 150 microsecond de-emphasis.
AUTOMATIC MUTE LEVEL: Variable from 0 to -30 dBm.
MUTE DELAY: Adjustable 0.5 to 20 seconds.
INJECTION LEVEL: 1% to 30% of composite. Adjustable.

WIDEBAND MODE

INPUT IMPEDANCE: Greater than 5000 ohms resistive, unbalanced.
INPUT LEVEL: 1.0 VRMS nominal for ± 75 kHz deviation.
AMPLITUDE RESPONSE: ± 0.25 dB, 30 Hz to 75 kHz.
PHASE LINEARITY: $\pm 2^\circ$, 30 Hz to 75 kHz.

SPECIFICATIONS SUBJECT TO CHANGE WITHOUT NOTICE

ORDERING INFORMATION

FM-20K, 20,000 watt FM broadcast transmitter with MS-15 exciter, for wideband operation, 60 Hz 994-8052-001
 Mono generator (add for mono operation) 994-8019-001
 DSM stereo generator with DTR (add for stereo operation) 994-8020-001
 SCA generator (add for SCA operation, specify 41 or 67 kHz) 994-7992-001



HARRIS

FM-10K

10-Kilowatt FM Broadcast Transmitter

- Solid-state Maximum Signal Exciter—MS-15
- Patented DSM Stereo Generator provides separation exceeding accurate measurement capability of most monitors
- DTR filter technique limits overshoot to 2% or less, permitting a 2 to 6 dB increase in loudness with no audio quality degradation
- Low operating cost
- Stable, easy output tuning
- Built-in connections for remote control
- Automatic recycling
- Full metering
- Plug-in mono, stereo and SCA generators

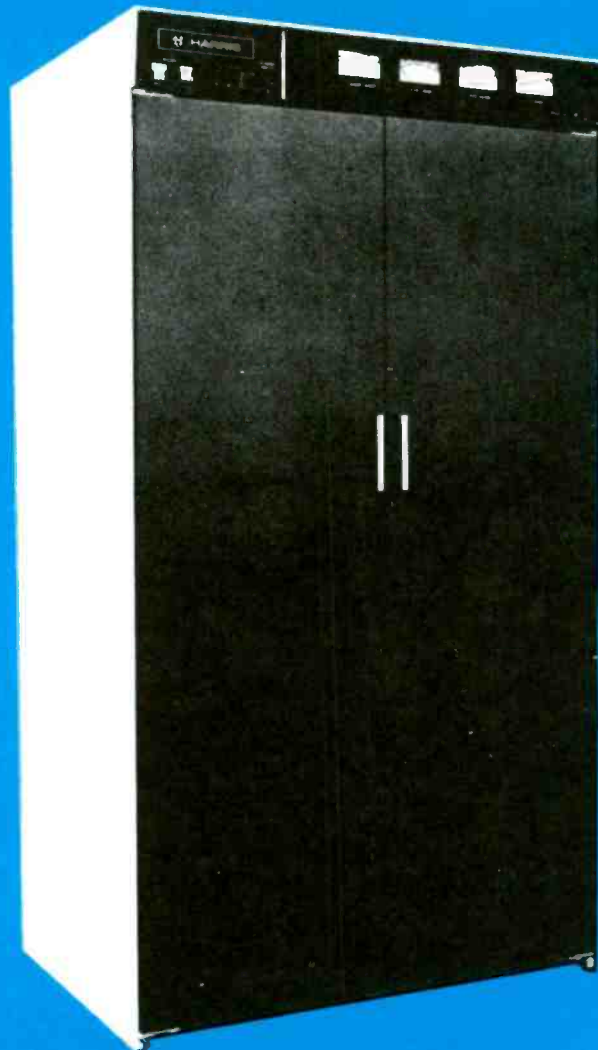

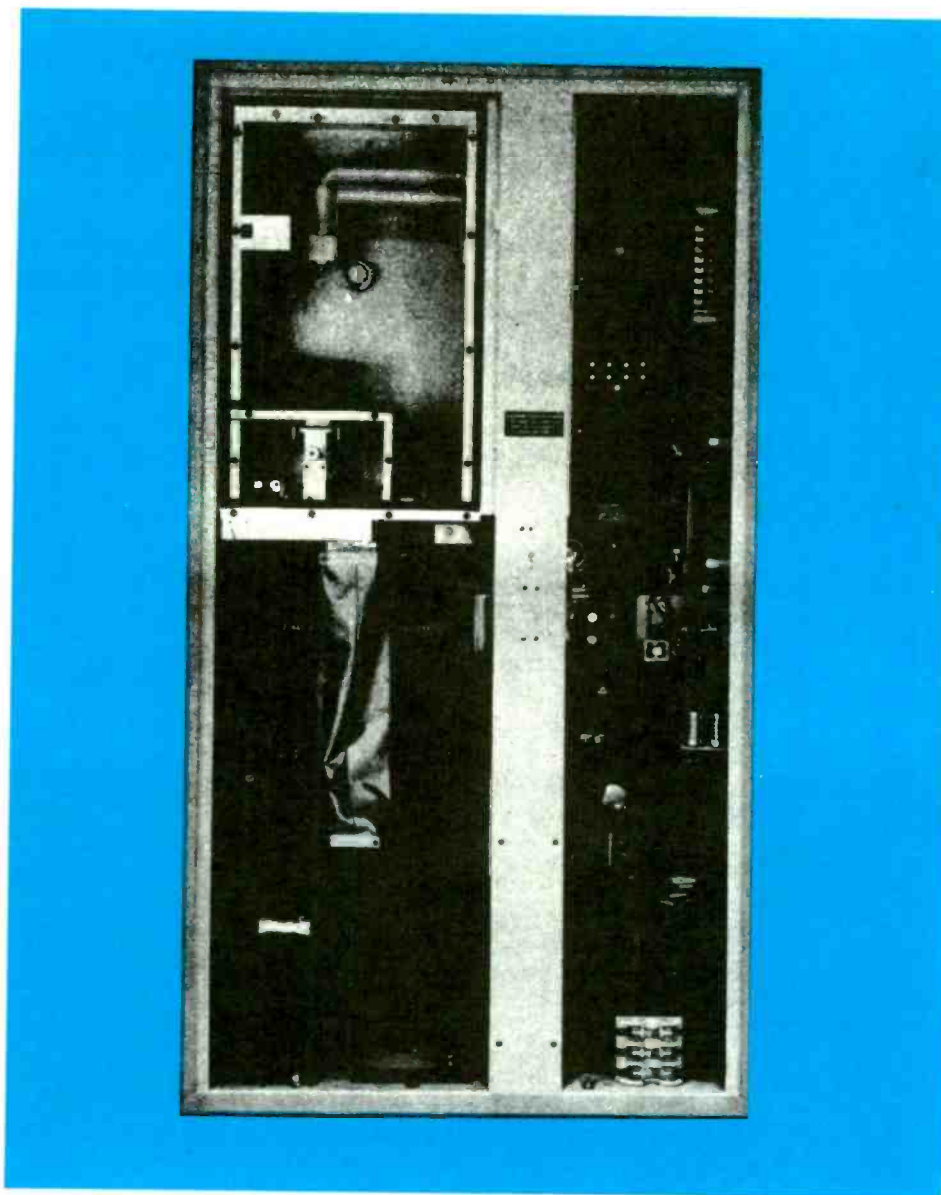

Featuring the advanced-design MS-15 exciter, Harris' FM-10K provides the cleanest and loudest stereo signal of any 10 kilowatt FM transmitter available today. The DSM (Digitally Synthesized Modulation) stereo generator allows the transmitter to provide stereo separation of 40 dB minimum, 30-15,000 Hz—while the DTR (Dynamic Transient Response) filter permits a 2 to 6 dB increase in loudness, with no degradation of audio quality, by limiting overshoot to 2% or less. Add to this high efficiency plus conservatively rated components and you have a really exceptional FM transmitter—the Harris FM-10K.

ONLY TWO TUBES. Just two tubes are employed in the FM-10K—a 4CX10,000D PA and a 4CX300A IPA. The ceramic-type 4CX10,000D is a high-gain tetrode that operates with a 2-to-1 dissipation safety margin, and was selected as the power amplifier because of its proven longer useful life.

"VARI-LINE" SILVER PLATED TANK.

Vari-Line is a Harris-developed method of tuning a single-ended FM amplifier for optimum output efficiency. A portion of a parallel tubular $1\frac{1}{8}$ inch copper transmission line (silver plated for efficient RF service) is made variable in order to inductively tune the line to operating frequency.

VSWR PROTECTION. To protect the transmitter PA, a VSWR overload circuit has been incorporated. The VSWR circuit monitors the reflected power from the output directional coupler and interrupts the high voltage power supply when the VSWR exceeds a pre-determined level. The transmitter will attempt to restart, and if the VSWR clears, return to air. Multiple VSWR trips within a given period will cause the transmitter to shut down.

AUTOMATIC RECYCLING. In case of momentary overload, the transmitter recycles automatically. Should the overload

reoccur in excess of the desired number of times preset in the transmitter, the FM-10K will then remain off the air until it is reset, either locally or by remote control.

HV SILICON POWER SUPPLY. One three-phase HV power supply is used in the FM-10K. It provides the PA plate voltage, PA screen voltage, and powers the IPA plate and screen circuits. The bias supply for the PA is a bridge circuit of four silicon rectifiers. The transmitter employs a special power supply protective circuit to assure maximum protection from transient voltages or on-off power surges.

BUILT-IN REMOTE CONTROL. Connect the transmitter control unit to the transmitter, tie in the telephone line to the studio control unit, and you are ready for complete remote control operation. All necessary functions can be controlled remotely—and no additional equipment is required for a Harris control system.

TESTING. Environmental tests, in conditions surpassing those of any location a transmitter is likely to encounter, have been imposed on the FM-10K. The transmitter is capable of operating at altitudes up to 10,000 feet (3000 meters), in an ambient temperature range of -20° to $+45^{\circ}$ C.

In addition, your FM-10K is fully tuned and operationally tested on your frequency before shipment.

METERING AND VISUAL AIDS. Six easy-to-read meters, including four multimeters, provide full monitoring of twenty-eight parameters in the transmitter and the exciter. To aid in fault location, a system of indicator lights provides status display of important transmitter parameters.

GENERAL. There are many other operational and convenience features incorporated into the FM-10K. These include:

Pushbutton Operation—On-off functions are controlled by lighted pushbuttons at the top left of the transmitter. These are clearly marked "Filament On-Off", "Plate On-Off".

High-Capacity Blower—backed up by a precision air-pressure switch gives complete protection to the IPA and PA tubes.

Straightforward Design—allows easy accessibility to all components.

AC Interruption Restart—this feature provides for automatically returning the transmitter "on air" after a temporary or indefinite outage of the AC power source. A front panel override switch is also provided.

FCC Type Acceptance—the FM-10K is FCC type accepted for mono or stereo broadcasting in the 87.5 to 108 MHz FM band.

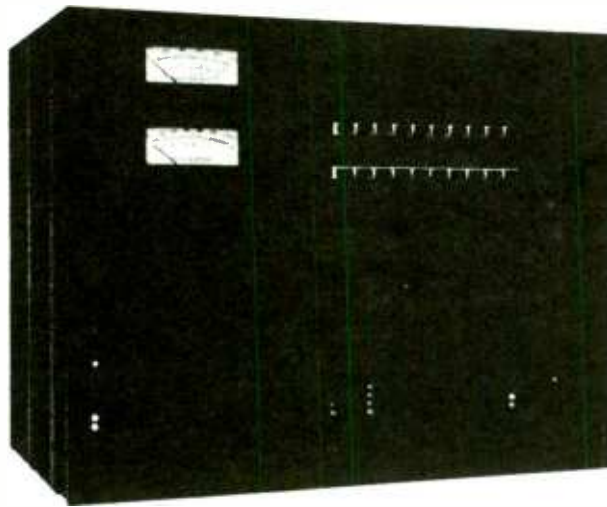

HARRIS' MS-15 . . . THE MOST ADVANCED FM EXCITER IN THE INDUSTRY

The solid-state MS-15 exciter employs Digitally Synthesized Modulation, overshoot compensation, and other exclusive design techniques, to give you an FM sound that is noticeably cleaner, noticeably louder than any competitive signal. The exciter is available for mono or stereo operation, with or without SCA. The modular construction of the MS-15 allows you to change the mode of operation, or to add SCA, at any time, by simply plugging in the appropriate module(s).

FCC approval of a system for quadrasonic FM will not obsolete the MS-15. Module positions exist which are ready to accept a quad generator.

DIGITALLY SYNTHESIZED MODULATION. The DSM stereo generator is a new development which eliminates the tradeoff that exists between switching type and balanced modulator types of stereo generators—poor separation at high frequencies in the former or poor harmonic rejection and SCA crosstalk in the latter. The DSM stereo generator is capable of both 50 dB separation (typical) through 15 kHz and an exceptionally clean baseband, promoting minimal interaction between stereo and SCA service. Also, pilot phase is automatically controlled so that high separation can be maintained under varying operating conditions.

OVERSHOOT COMPENSATION. A Dynamic Transient Response (DTR) filter has been developed by Harris for FM stereo, with overshoot no greater than 2% on any program material processed by any limiter. As a result, from 2 to 6 dB increased loudness can be achieved without degradation of audio quality. Controlled transient response, high stereo separation, low crosstalk, and low intermodulation distortion are all maintained with increased

loudness. For monaural stations wishing to protect 41 and/or 67 kHz SCA channels, a defeatable linear phase lowpass filter is provided for optimal linear control of overshoot.

COMPATIBILITY. The MS-15 exciter is mechanically and electrically compatible with the Harris TE-3 exciter. Mountings are in the same location and use the same hardware.

RF output power is 15 watts into 50 ohms, continuously adjustable to 3 watts by one control. A directional coupler samples and meters forward and reflected power, with remote metering capability. A harmonic filter is placed at the RF module output, reducing harmonics to a low level. The balanced 600 ohm audio input is transformerless to give maximum common mode rejection and excellent response. Inputs will withstand high transients or steady state voltages above or below ground reference.

The basic exciter audio response is wide-band and flat, and can be used directly with a studio-transmitter link. The exciter is self-contained, including the power supply.

OTHER FEATURES. The Harris MS-15 exciter can be quickly and easily programmed to any carrier frequency in the 87.5 to 108 MHz band in 50 kHz increments. The RF output network is broadband and requires no tuning. Carrier frequencies are generated through a digital synthesizer which is locked to a 10 MHz TCXO high stability frequency standard. The TCXO has improved crystal aging characteristics and does not require an oven. The synthesizer also provides outputs at 2.5, 5, 10, 15, 20 and 25 MHz for easy frequency comparison to the National Bureau of Standards WWV transmissions.

Pre-emphasis is selectable to 75, 50, 25 or 0 microseconds in either monophonic or stereophonic operation.

Remote control capability includes switching between stereo and mono, and selection of left, right, or left-plus-right inputs for monophonic operation.

SCA OPERATION. SCA operation is added to the exciter through a plug-in module. It is available with either stereo or mono operation; up to two channels can be added to mono exciters, or a single SCA used with stereo. Any channel between 25 kHz and 75 kHz can be used, although 41 kHz and 67 kHz are normally provided. Either frequency is selectable on the SCA channel card.

Pre-emphasis is selectable to 150, 75, 50 or 0 microseconds. The input audio is applied to a programmable lowpass filter, and the output of the SCA generator filtered so that 150 microseconds pre-emphasis can be used with no degradation of SCA to main channel crosstalk.

Each SCA module has a pair of audio inputs, one AC coupled for audio, and the other DC coupled for data and video transmission.

The subcarrier level is adjustable to provide from 1% to 30% composite baseband SCA injection. When an SCA subcarrier is turned on or off, an automatic composite level switcher noiselessly compensates for the change in baseband injection level. 100% peak modulation is maintained independent of SCA status.

EASE OF MAINTENANCE. The entire exciter is modular for ease of troubleshooting and maintenance. An extender card is provided to allow easy servicing. Extensive metering is provided, and LED status lights on the modules indicate various performance features.

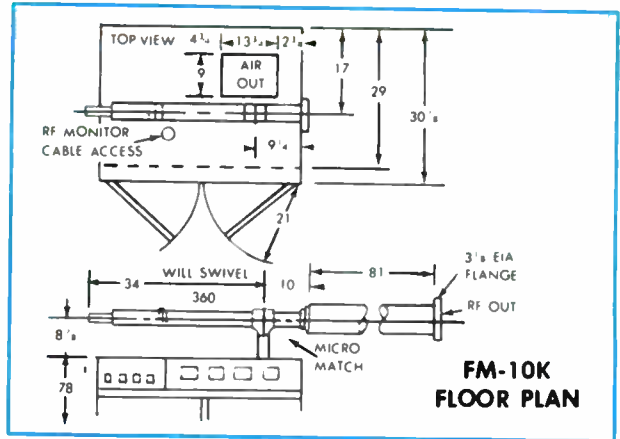
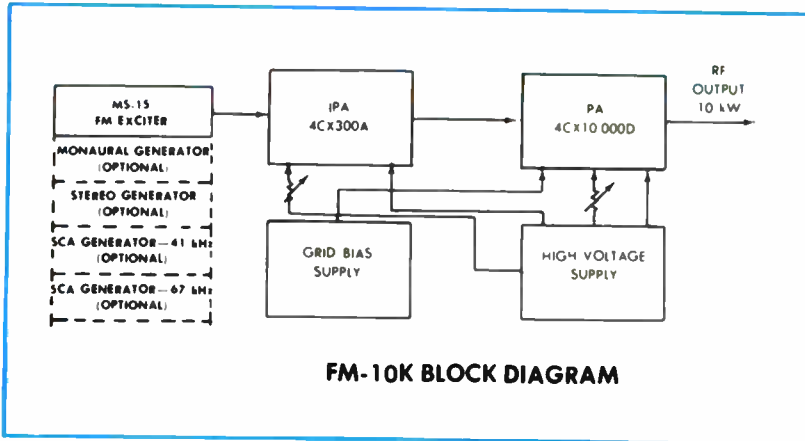

FM-10K SPECIFICATIONS

GENERAL

POWER OUTPUT: 10 kW.
FREQUENCY RANGE: 87.5 to 108 MHz, tuned to specified operating frequency.
RF OUTPUT IMPEDANCE: 50 ohms.
OUTPUT TERMINATION: 3 1/2" EIA flange.
FREQUENCY STABILITY: ±300 Hz 0° to 45°C TCXO.
TYPE OF MODULATION: Direct Carrier Frequency Modulation.
MODULATION CAPABILITY: ±100 kHz.
AC INPUT POWER: 208/240 V, 3-phase, 60 Hz (50 Hz available.) Power consumption: 17,000 watts (approx.). 115/230 V, 60 or 50 Hz, 150 watts for MS-15.
RF HARMONICS: Suppression meets all FCC requirements.
POWER SUPPLY RECTIFIERS: Silicon.
ALTITUDE: 10,000 feet (3000 meters).
AMBIENT TEMPERATURE RANGE: —20°C to +45°C.
MAXIMUM VSWR: 1.7 to 1.
SIZE: Transmitter cabinet, 42"W (107cm) x 78"H (198cm) x 33"D (84cm).
FRONT DOOR SWING: 21" (53cm).
FINISH: White, blue and black.
WEIGHT AND CUBAGE: Export: 2200 lbs. (998 kg). Domestic: 1800 lbs. (817 kg). 120 cubic feet.

MONAURAL MODE

AUDIO INPUT IMPEDANCE: 600 ohms balanced, resistive, adaptable to other impedances.
INPUT FILTER: Controlled response LPF, defeatable.
AUDIO INPUT LEVEL: +10 dBm ±1 dB for 100% modulation at 400 Hz.
AUDIO FREQUENCY RESPONSE: Standard 75 microsecond FCC pre-emphasis curve ±0.5 dB, 30-15,000 Hz. Selectable: flat, 25 or 50 microsecond pre-emphasis.
HARMONIC DISTORTION: 0.2% or less, 30-15,000 Hz.
IMD: 0.2%, 60/7000 Hz, 4:1 ratio.
FM NOISE: 68 dB below 100% modulation (ref. 400 Hz @ ±75 kHz deviation).
AM NOISE: 50 dB below reference carrier AM modulation 100%.

STEREOPHONIC MODE

TYPE OF MODULATION: Digitally Synthesized Modulation (DSM).
AUDIO INPUT IMPEDANCE: (left and right) 600 ohms balanced, resistive. Adaptable to other impedances.
AUDIO INPUT LEVEL: (left and right) +10 dBm ±1 dB for 100% modulation at 400 Hz.
AUDIO FREQUENCY RESPONSE: (left and right) Standard 75 microsecond, FCC pre-emphasis curve ±0.5 dB 30-15,000 Hz. Selectable: flat, 25 or 50 microsecond pre-emphasis.
INPUT FILTERING: 15 kHz LPF, 45 dB rejection at 19 kHz.
OVERSHOOT PROTECTION: Dynamic transient response (DTR) filter.
AUDIO TRANSIENT RESPONSE: 2% maximum overshoot beyond steady state. Defeatable for test purposes.

HARMONIC DISTORTION: (left or right) 0.4% or less, 30-15,000 Hz.
IMD: 0.4%, 60/7000 Hz, 4:1 ratio.
FM NOISE: (left or right) 65 dB minimum below 100% modulation. Reference: 400 Hz, 75 microsecond de-emphasis, ±75 kHz deviation.
PILOT OSCILLATOR: Crystal controlled.
PILOT STABILITY: 19 kHz ±1 Hz, 0° to 45°C.
PILOT PHASE: Automatically controlled.
STEREO SEPARATION: 40 dB minimum 30-15,000 Hz.
CROSSTALK: (main to stereo sub-channel or stereo sub-to main channel) 45 dB below 90% modulation.
SUB CARRIER SUPPRESSION: 50 dB below 90% modulation.
76 kHz SUPPRESSION: 60 dB minimum below 100% modulation.
MODES: Stereo, mono (L + R), mono (L), mono (R). Remoteable.

SCA SPECIFICATIONS

MODULATION: Direct FM.
FREQUENCY: 41 or 67 kHz programmable, any frequency between 25 and 75 kHz on special order.
FREQUENCY STABILITY: ±500 Hz.
MODULATION CAPABILITY: ±7.5 kHz.
AUDIO INPUT IMPEDANCE: 600 ohms balanced (AC coupled) and 2000 ohms unbalanced (DC coupled).
AUDIO INPUT LEVEL: +10 dBm ±1 dB for 100% modulation at 400 Hz.
AUDIO FREQUENCY RESPONSE: 41 kHz and 67 kHz, 150 microsecond pre-emphasis ±1 dB, standard. Selectable: flat, 50 or 75 microsecond pre-emphasis.
INPUT FILTERING: Programmable LPF, 4.5 kHz standard.
DISTORTION: Less than 1%, 30-5000 Hz. ±5 kHz deviation.
FM NOISE: (main channel not modulated) 55 dB minimum (ref: 100% = ±5 kHz deviation at 400 Hz).
CROSSTALK: (SCA to main or stereo sub-channel): —60 dB or better.
CROSSTALK: (main or stereo sub-channel to SCA): 50 dB below ±5 kHz deviation of SCA, with mono or stereo channels modulated by frequencies 30-15,000 Hz, SCA demodulated with 150 microsecond de-emphasis.
CROSSTALK: SCA to SCA (41 kHz/67 kHz) 50 dB demodulated with 150 microsecond de-emphasis.
AUTOMATIC MUTE LEVEL: Variable from 0 to —30 dBm.
MUTE DELAY: Adjustable 0.5 to 20 seconds.
INJECTION LEVEL: 1% to 30% of composite. Adjustable.

WIDEBAND MODE

INPUT IMPEDANCE: Greater than 5000 ohms resistive, unbalanced.
INPUT LEVEL: 1.0 VRMS nominal for ±75 kHz deviation.
AMPLITUDE RESPONSE: ±0.25 dB, 30 Hz to 75 kHz.
PHASE LINEARITY: ±2°, 30 Hz to 75 kHz.

Specifications subject to change without notice.

ORDERING INFORMATION

FM-10K, 10,000 watt FM transmitter with MS-15 exciter, for wideband operation, 60 Hz.	994-8051-001
As above, except for 50 Hz operation	994-8051-002
Mono generator (add for mono operation)	994-8019-001
DSM stereo generator with DTR (add for stereo operation)	994-8020-001
SCA generator (add for SCA operation, specify 41 or 67 kHz)	994-7992-001



HARRIS

FM-5K

**5-Kilowatt
FM Broadcast
Transmitter**

- Solid-state Maximum Signal Exciter—MS-15
- Patented DSM Stereo Generator provides separation exceeding accurate measurement capability of most monitors
- DTR filter technique limits overshoot to 2% or less, permitting a 2 to 6 dB increase in loudness with no audio quality degradation
- Low operating costs
- Stable, easy output tuning
- Built-in connections for remote control
- Automatic recycling
- Full metering
- Plug-in mono, stereo and SCA generators

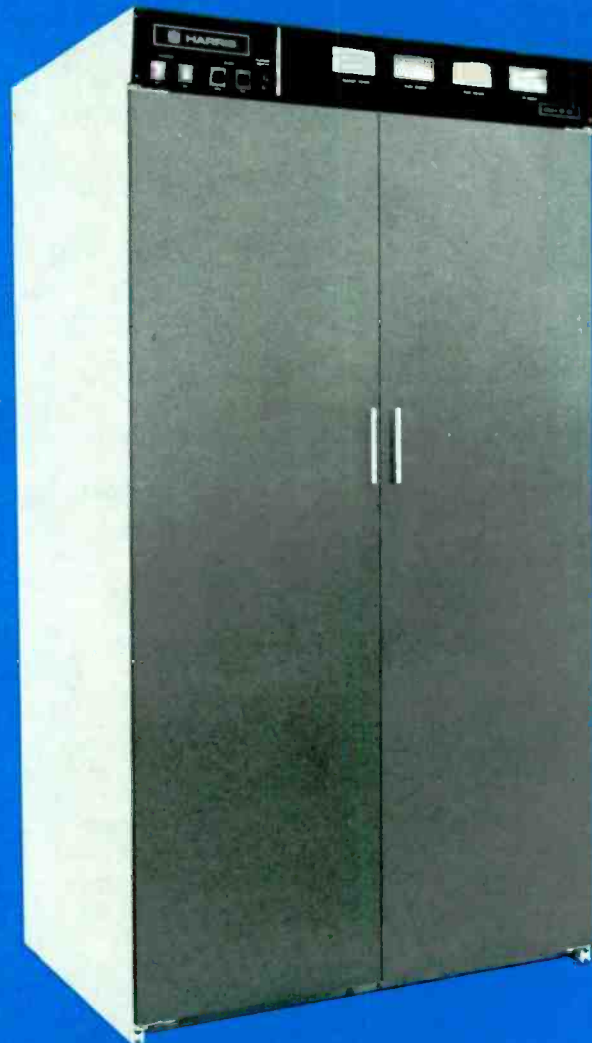

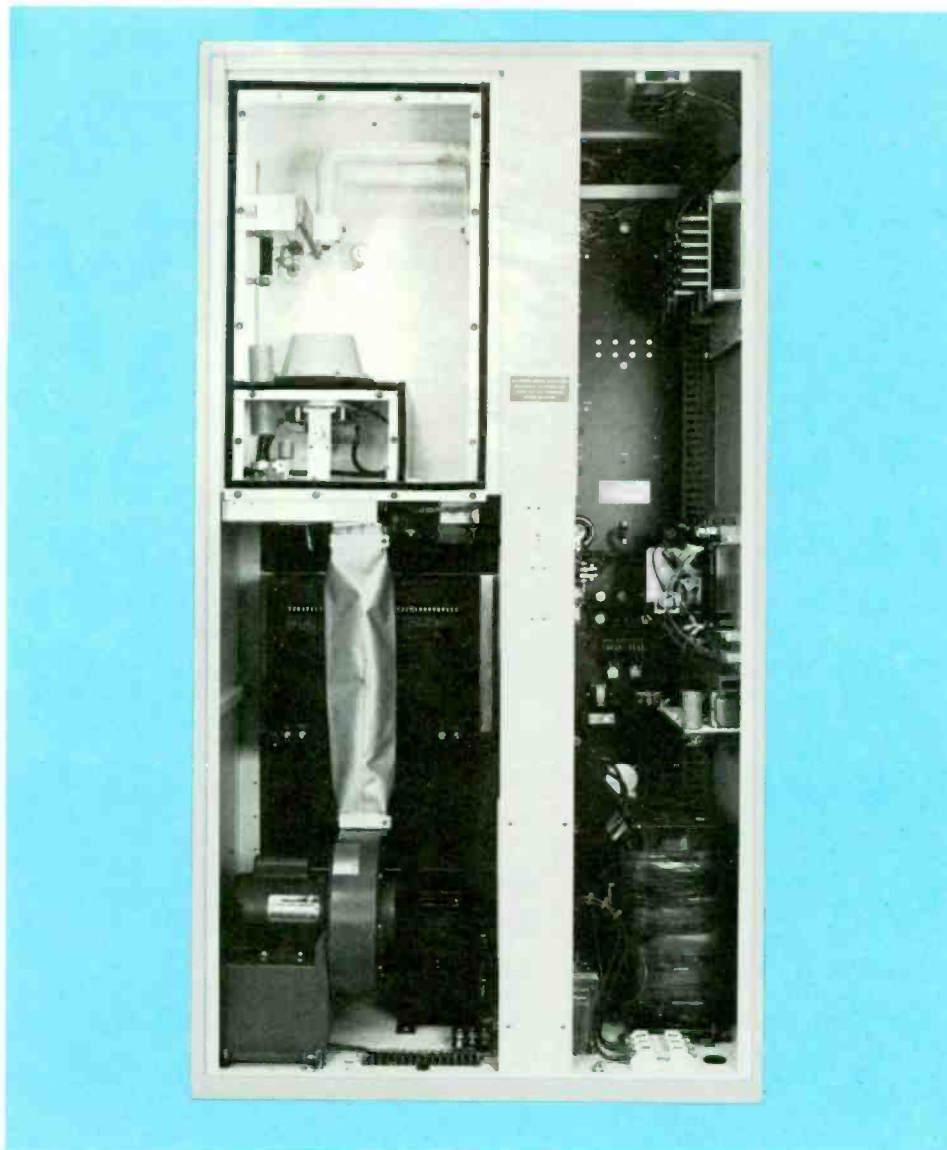

Featuring the advanced-design MS-15 exciter, the Harris 5 kW FM-5K provides the cleanest and the loudest stereo signal of any FM transmitter in its power range. The DSM (Digitally Synthesized Modulation) stereo generator allows the transmitter to provide stereo separation of 40 dB minimum, 30-15,000 Hz—while the DTR (Dynamic Transient Response) filter permits a 2 to 6 dB increase in loudness, with no degradation of audio quality, by limiting overshoot to 2% or less. Add to this high efficiency plus conservatively rated components and you have a truly exceptional FM transmitter.

ONLY TWO TUBES. Just two tubes are employed in the transmitter. A type 4CX-250B tube amplifies the solid-state exciter output and supplies a nominal 250 watts to drive the ceramic 4CX5000A final amplifier. This power tetrode operates as a single ended amplifier to produce 5 kilowatts of RF power.

"VARI-LINE" SILVER PLATED TANK. Vari-Line is a Harris-developed method of

tuning a single-ended FM amplifier for optimum output efficiency. A portion of a parallel tubular 1½ inch copper transmission line (silver plated for efficient RF service) is made variable in order to inductively tune the line to operating frequency.

AUTOMATIC RECYCLING. In case of momentary overload, recycling takes place automatically. Should an overload reoccur in excess of the number of times preset, the transmitter will then remain off the air until it is reset, either locally or by remote control.

VSWR PROTECTION. To protect the transmitter PA, a VSWR overload circuit has been incorporated. The VSWR circuit monitors the reflected power from the output directional coupler and interrupts the high voltage power supply when the VSWR exceeds a pre-determined level. The transmitter will attempt to restart, and if the VSWR clears, return to air. Multiple VSWR trips within a given period will cause the transmitter to shut down.

HV SILICON POWER SUPPLY. All power supplies are housed inside the transmitter cabinet. One three-phase supply provides the PA plate voltage, and powers the IPA plate and screen circuits. The transmitter employs a special power supply protective circuit to assure maximum protection from transient voltages or on-off power surges.

BUILT-IN REMOTE CONTROL. Connect the transmitter control unit to the transmitter, tie in the telephone line to the studio control unit, and you are ready for complete remote control operation. All necessary functions can be controlled remotely—and no additional equipment is required for a Harris remote control system.

TESTING. Environmental tests, in conditions surpassing those of any location a transmitter is likely to encounter, have been imposed on the FM-5K. The transmitter is capable of operating at altitudes up to 7,500 feet (2250 meters), in an ambient temperature range of -20° to +45° C.

In addition, your transmitter is fully tuned and operationally tested on your frequency before shipment.

METERING AND VISUAL AIDS. Six meters, including four large, front-panel meters, provide full monitoring of the transmitter's operating parameters. Included is a power indicator that permits direct reading of both power output and standing wave ratio. To aid in fault location, a system of indicator lights provides status display of important transmitter parameters.

GENERAL. There are many other operational and convenience features incorporated into the FM-5K transmitter. These include:

Pushbutton Operation—On-off functions are controlled by lighted pushbuttons at the top left of the transmitter. These are clearly marked "Filament On-Off", "Plate On-Off".

High-Capacity Blower—backed up by a precision air-pressure switch gives complete protection to the IPA and PA tubes.

Straightforward Design—allows easy accessibility to all components.

AC Interruption Restart—this feature provides for automatically returning the transmitter "on air" after a temporary or indefinite outage of the AC power source. A front panel override switch is also provided.

FCC Type Acceptance—The transmitter is FCC type accepted for mono, stereo and SCA broadcasting in the 87.5 to 108 MHz FM band.

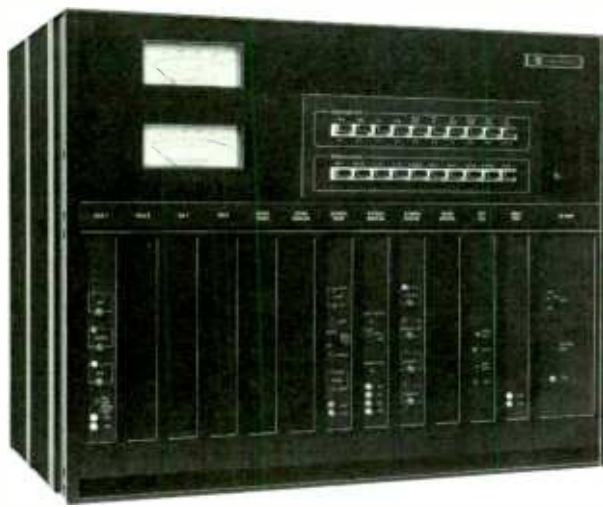

HARRIS' MS-15 . . . THE MOST ADVANCED FM EXCITER IN THE INDUSTRY

The solid-state MS-15 exciter employs Digitally Synthesized Modulation, overshoot compensation, and other exclusive design techniques, to give you an FM sound that is noticeably cleaner, noticeably louder than any competitive signal. The exciter is available for mono or stereo operation, with or without SCA. The modular construction of the MS-15 allows you to change the mode of operation, or to add SCA, at any time, by simply plugging in the appropriate module(s).

FCC approval of a system for quadraphonic FM will not obsolete the MS-15. Module positions exist which are ready to accept a quad generator.

DIGITALLY SYNTHESIZED MODULATION. The DSM stereo generator is a new development which eliminates the tradeoff that exists between switching type and balanced modulator types of stereo generators—poor separation at high frequencies in the former or poor harmonic rejection and SCA crosstalk in the latter. The DSM stereo generator is capable of both 50 dB separation (typical) through 15 kHz and an exceptionally clean baseband, promoting minimal interaction between stereo and SCA service. Also, pilot phase is automatically controlled so that high separation can be maintained under varying operating conditions.

OVERSHOOT COMPENSATION. A Dynamic Transient Response (DTR) filter has been developed by Harris for FM stereo, with overshoot no greater than 2% on any program material processed by any limiter. As a result, from 2 to 6 dB increased loudness can be achieved without degradation of audio quality. Controlled transient response, high stereo separation, low crosstalk, and low intermodulation distortion are all maintained with increased

loudness. For monaural stations wishing to protect 41 and/or 67 kHz SCA channels, a defeatable linear phase lowpass filter is provided for optimal linear control of overshoot.

COMPATIBILITY. The MS-15 exciter is mechanically and electrically compatible with the Harris TE-3 exciter. Mountings are in the same location and use the same hardware.

RF output power is 15 watts into 50 ohms, continuously adjustable to 3 watts by one control. A directional coupler samples and meters forward and reflected power, with remote metering capability. A harmonic filter is placed at the RF module output, reducing harmonics to a low level. The balanced 600 ohm audio input is transformerless to give maximum common mode rejection and excellent response. Inputs will withstand high transients or steady state voltages above or below ground reference.

The basic exciter audio response is wide-band and flat, and can be used directly with a studio-transmitter link. The exciter is self-contained, including the power supply.

OTHER FEATURES. The Harris MS-15 exciter can be quickly and easily programmed to any carrier frequency in the 87.5 to 108 MHz band in 50 kHz increments. The RF output network is broadband and requires no tuning. Carrier frequencies are generated through a digital synthesizer which is locked to a 10 MHz TCXO high stability frequency standard. The TCXO has improved crystal aging characteristics and does not require an oven. The synthesizer also provides outputs at 2.5, 5, 10, 15, 20 and 25 MHz for easy frequency comparison to the National Bureau of Standards WWV transmissions.

Pre-emphasis is selectable to 75, 50, 25 or 0 microseconds in either monophonic or stereophonic operation.

Remote control capability includes switching between stereo and mono, and selection of left, right, or left-plus-right inputs for monophonic operation.

SCA OPERATION. SCA operation is added to the exciter through a plug-in module. It is available with either stereo or mono operation; up to two channels can be added to mono exciters, or a single SCA used with stereo. Any channel between 25 kHz and 75 kHz can be used, although 41 kHz and 67 kHz are normally provided. Either frequency is selectable on the SCA channel card.

Pre-emphasis is selectable to 150, 75, 50 or 0 microseconds. The input audio is applied to a programable lowpass filter, and the output of the SCA generator filtered so that 150 microseconds pre-emphasis can be used with no degradation of SCA to main channel crosstalk.

Each SCA module has a pair of audio inputs, one AC coupled for audio, and the other DC coupled for data and video transmission.

The subcarrier level is adjustable to provide from 1% to 30% composite baseband SCA injection. When an SCA subcarrier is turned on or off, an automatic composite level switcher noiselessly compensates for the change in baseband injection level. 100% peak modulation is maintained independent of SCA status.

EASE OF MAINTENANCE. The entire exciter is modular for ease of troubleshooting and maintenance. An extender card is provided to allow easy servicing. Extensive metering is provided, and LED status lights on the modules indicate various performance features.

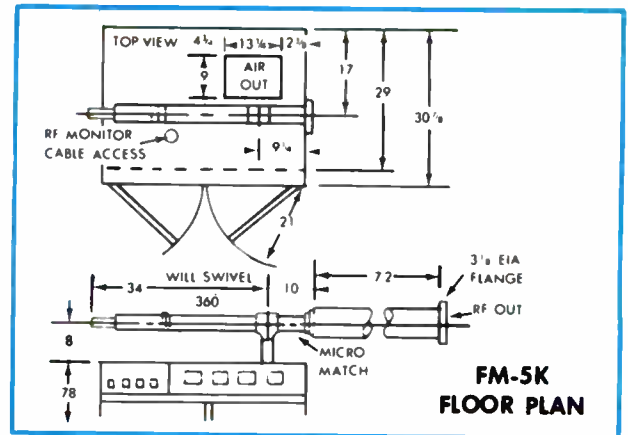
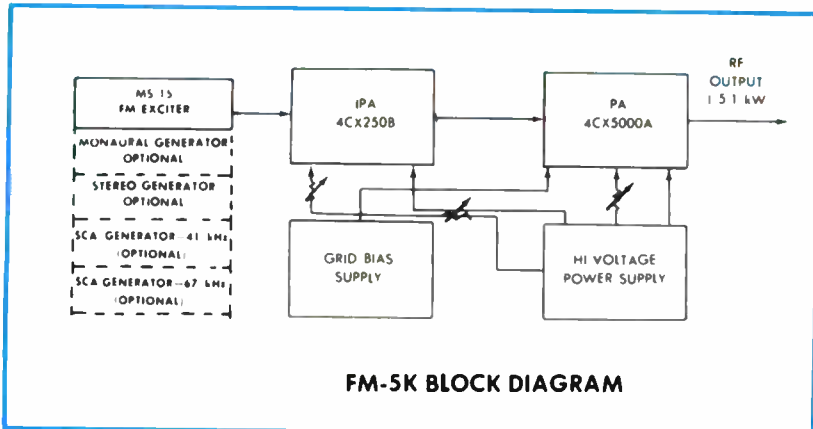

FM-5K SPECIFICATIONS

GENERAL

POWER OUTPUT: 1.0 to 5.1 kW.
FREQUENCY RANGE: 87.5 to 108 MHz, tuned to specified operating frequency.
RF OUTPUT IMPEDANCE: 50 ohms.
OUTPUT TERMINATION: 3/8" EIA flange.
FREQUENCY STABILITY: ±300 Hz 0° to 45°C TCXO.
TYPE OF MODULATION: Direct Carrier Frequency Modulation.
MODULATION CAPABILITY: ±100 kHz.
AC INPUT POWER: 208/240 V, 3-phase, 60 Hz (50 Hz available.) Power consumption (approx.): 10 kW consumption at 5 kW output. 115/230 V, 60 or 50 Hz, 150 watts for MS-15.
RF HARMONICS: Suppression meets all FCC requirements.
POWER SUPPLY RECTIFIERS: Silicon.
ALTITUDE: 7,500 feet (2250 meters).
AMBIENT TEMPERATURE RANGE: -20°C to +45°C.
MAXIMUM VSWR: 1.7 to 1.
SIZE: Transmitter cabinet, 42"W (107cm) x 78"H (198cm) x 33"D (84cm).
FRONT DOOR SWING: 21" (53cm).
FINISH: White, blue and black.
WEIGHT AND CUBAGE: Export: 2100 lbs. (953 kg). Domestic: 1700 lbs. (771 kg). 120 cubic feet.

MONAURAL MODE

AUDIO INPUT IMPEDANCE: 600 ohms balanced, resistive, adaptable to other impedances.
INPUT FILTER: Controlled response LPF, defeatable.
AUDIO INPUT LEVEL: +10 dBm ±1 dB for 100% modulation at 400 Hz.
AUDIO FREQUENCY RESPONSE: Standard 75 microsecond FCC pre-emphasis curve ±0.5 dB, 30-15,000 Hz. Selectable: flat, 25 or 50 microsecond pre-emphasis.
HARMONIC DISTORTION: 0.2% or less, 30-15,000 Hz.
IMD: 0.2%, 60/7000 Hz, 4:1 ratio.
FM NOISE: 68 dB below 100% modulation (ref. 400 Hz @ ±75 kHz deviation).
AM NOISE: 50 dB below reference carrier AM modulation 100%.

STEREOPHONIC MODE

TYPE OF MODULATION: Digitally Synthesized Modulation (DSM).
AUDIO INPUT IMPEDANCE: (left and right) 600 ohms balanced, resistive. Adaptable to other impedances.
AUDIO INPUT LEVEL: (left and right) +10 dBm ±1 dB for 100% modulation at 400 Hz.
AUDIO FREQUENCY RESPONSE: (left and right) Standard 75 microsecond, FCC pre-emphasis curve ±0.5 dB 30-15,000 Hz. Selectable: flat, 25 or 50 microsecond pre-emphasis.
INPUT FILTERING: 15 kHz LPF, 45 dB rejection at 19 kHz.
OVERSHOOT PROTECTION: Dynamic transient response (DTR) filter.
AUDIO TRANSIENT RESPONSE: 2% maximum overshoot beyond steady state. Defeatable for test purposes.

HARMONIC DISTORTION: (left or right) 0.4% or less, 30-15,000 Hz.
IMD: 0.4%, 60/7000 Hz, 4:1 ratio.
FM NOISE: (left or right) 65 dB minimum below 100% modulation. Reference: 400 Hz, 75 microsecond de-emphasis, ±75 kHz deviation.
PILOT OSCILLATOR: Crystal controlled.
PILOT STABILITY: 19 kHz ±1 Hz, 0° to 45°C.
PILOT PHASE: Automatically controlled.
STEREO SEPARATION: 40 dB minimum 30-15,000 Hz.
CROSSTALK: (main to stereo sub-channel or stereo sub-to-main channel) 45 dB below 90% modulation.
SUB CARRIER SUPPRESSION: 50 dB below 90% modulation.
76 kHz SUPPRESSION: 60 dB minimum below 100% modulation.
MODES: Stereo, mono (L + R), mono (L), mono (R). Remoteable.

SCA SPECIFICATIONS

MODULATION: Direct FM.
FREQUENCY: 41 or 67 kHz programable, any frequency between 25 and 75 kHz on special order.
FREQUENCY STABILITY: ±500 Hz.
MODULATION CAPABILITY: ±7.5 kHz.
AUDIO INPUT IMPEDANCE: 600 ohms balanced (AC coupled) and 2000 ohms unbalanced (DC coupled).
AUDIO INPUT LEVEL: +10 dBm ±1 dB for 100% modulation at 400 Hz.
AUDIO FREQUENCY RESPONSE: 41 kHz and 67 kHz, 150 microsecond pre-emphasis ±1 dB, standard. Selectable: flat, 50 or 75 microsecond pre-emphasis.
INPUT FILTERING: Programable LPF, 4.5 kHz standard.
DISTORTION: Less than 1%, 30-5000 Hz. ±5 kHz deviation.
FM NOISE: (main channel not modulated) 55 dB minimum (ref: 100% = ±5 kHz deviation at 400 Hz).
CROSSTALK: (SCA to main or stereo sub-channel): -60 dB or better.
CROSSTALK: (main or stereo sub-channel to SCA): 50 dB below ±5 kHz deviation of SCA, with mono or stereo channels modulated by frequencies 30-15,000 Hz, SCA demodulated with 150 microsecond de-emphasis.
CROSSTALK: SCA to SCA (41 kHz/67 kHz) 50 dB demodulated with 150 microsecond de-emphasis.
AUTOMATIC MUTE LEVEL: Variable from 0 to -30 dBm.
MUTE DELAY: Adjustable 0.5 to 20 seconds.
INJECTION LEVEL: 1% to 30% of composite. Adjustable.

WIDEBAND MODE

INPUT IMPEDANCE: Greater than 5000 ohms resistive, unbalanced.
INPUT LEVEL: 1.0 VRMS nominal for ±75 kHz deviation.
AMPLITUDE RESPONSE: ±0.25 dB, 30 Hz to 75 kHz.
PHASE LINEARITY: ±2°, 30 Hz to 75 kHz.

Specifications subject to change without notice.

ORDERING INFORMATION

FM-5K, 5 kW FM transmitter with MS-15 exciter, for wideband operation, 60 Hz.	994-8049-001
As above, except for 50 Hz operation	994-8049-002
Mono generator (add for mono operation)	994-8019-001
DSM stereo generator with DTR (add for stereo operation)	994-8020-001
SCA generator (add for SCA operation, specify 41 or 67 kHz)	994-7992-001



HARRIS

FM-2.5K

**2.5-Kilowatt
FM Broadcast
Transmitter**

- Solid-state Maximum Signal Exciter—MS-15
- Digitally Synthesized Modulation for high stereo separation
- Overshoot compensation
- Low power consumption
- Single phase power
- Stable, easy output tuning
- All connections for remote control built in
- Automatic recycling
- Full metering
- Plug in mono, stereo and SCA generators

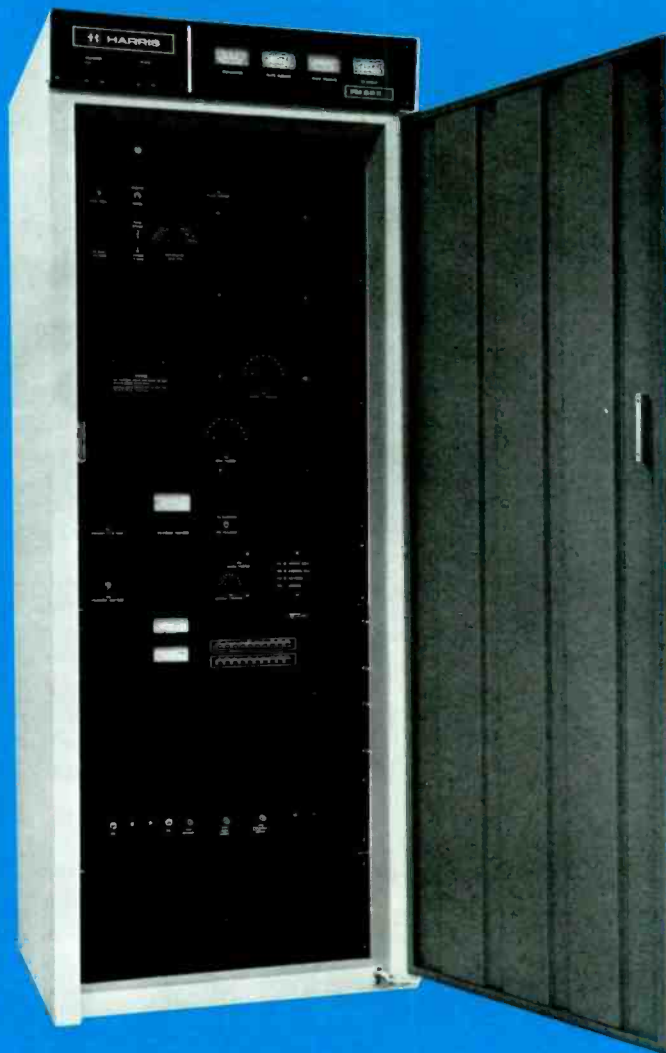

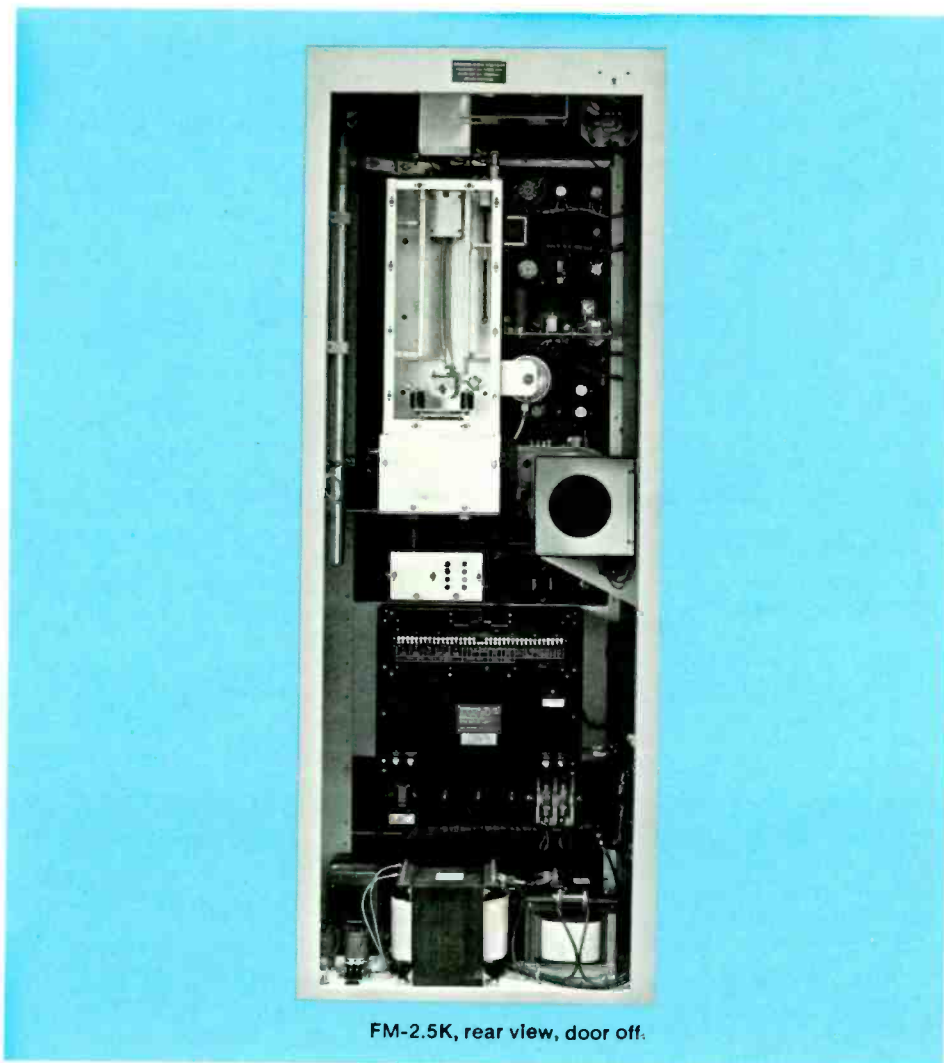

FM-2.5K, rear view, door off.

The FM-2.5K employs Harris' exclusive, advanced-design MS-15 solid state exciter, with Digitally Synthesized Modulation (DSM), to provide the very finest stereo signal available. Technical specifications are exceptional compared to other 2.5 kilowatt FM transmitters on the market. And DSM with overshoot compensation allows a 2 to 6 dB increase in loudness with no degradation of audio quality!

The transmitter consumes only 4.8 kilowatts at full output—and will provide 3000 watts effective radiated power in both horizontal and vertical planes when used with a Harris 3-bay FMC-3A Dual Cycloid III antenna. This assumes a coaxial cable efficiency of as low as 82%.

The FM-2.5K uses single phase power . . . in areas where this is the only type of power available, no additional lines are required.

Two tubes are employed in the FM-2.5K—the 4X150A intermediate power amplifier, and the 5CX1500A single-ended final power amplifier.

PLUG-IN MONO, STEREO AND SCA GENERATORS. The FM-2.5K may be

equipped for mono or stereo operation, with or without SCA. The design versatility of the exciter allows you to order for mono operation originally, then add stereo and/or SCA at a later date by plugging the appropriate module(s) into the exciter. Since the SCA generators have spectrally pure filtered outputs, 41 and 67 kHz SCA channels may be operated simultaneously while in the mono mode without harmonic interference.

STABLE, EASY OUTPUT TUNING. Plate tuning of the final amplifier is stable and easily adjusted. The plate circuit is a shorted, one-quarter wavelength configuration, with the plate line operated at DC ground potential. Coarse plate tuning is pre-set for the operating frequency on the plate line. Fine adjustment is made with the plate tuning knob on the front panel. Amplifier loading is changed by a variable output loading control.

AUTOMATIC RECYCLING. The recycle circuitry in the FM-2.5K is adjustable, self-clearing and uncomplicated. Should a momentary overload occur, the transmitter will recycle automatically. If the overload occurs in excess of the number of times pre-set, the transmitter will remain

off the air until it is reset, either manually or by remote control.

POWER OUTPUT CONTROL. The transmitter has a built-in motor-operated rheostat connected to the screen supply for adjusting the power output. A built-in reflectometer with a VSWR power meter makes adjustments of the power output easy and accurate.

REMOTE CONTROL. The FM-2.5K features built-in remote metering for the plate voltage, plate current and power output. No interface components are required to adapt a Harris remote control system to the transmitter. The transmitter's remote control circuitry can also be interfaced easily to other manufacturers' remote systems.

PUSHBUTTON OPERATION. Manual operation of the transmitter is simple. On-Off functions are controlled by lighted, dual pushbuttons at the top left of the cabinet. They are clearly marked Filament On and Off, Plate On and Off. After the filaments of the tubes are turned on, a time-delay relay allows the cathodes to reach operating temperatures before the plate power can be turned on.

COMPLETE TESTING. Environmental tests, in conditions surpassing those of any location a transmitter is likely to encounter, have been imposed on the FM-2.5K. The transmitter is capable of operating at altitudes to 7500 feet, in an ambient temperature range of -20° to $+45^{\circ}\text{C}$.

In addition, your FM-2.5K is fully tuned and operationally tested on your frequency before shipment.

HARMONIC FILTER STANDARD. Supplied with a Harris-designed harmonic filter, the transmitter fully meets FCC requirements for spurious radiation. All filtering is mounted inside the transmitter cabinet and provides rapid cut-off of second and higher order harmonics.

QUALITY COMPONENTS. Every transmitter component is conservatively operated and chosen to give optimum performance in continuous duty service. In Harris' MS-15 exciter, only performance-proven solid-state devices and precision temperature compensated components are used throughout.

STYLING. Handsomely yet functionally styled, the transmitter cabinet is finished in white and blue, with a black meter panel. The FM-2.5K is completely self-contained in one cabinet, and simplicity of design allows easy access to all components.

TYPE ACCEPTANCE. The FM-2.5K is FCC type accepted for mono or stereo broadcasting in the 87.5 to 108 MHz band.



HARRIS' MS-15...THE MOST ADVANCED FM EXCITER IN THE INDUSTRY

The solid-state MS-15 exciter employs Digitally Synthesized Modulation, overshoot compensation, and other exclusive design techniques, to give you an FM sound that is noticeably cleaner, noticeably louder than any competitive signal. The exciter is available for mono or stereo operation, with or without SCA. The modular construction of the MS-15 allows you to change the mode of operation, or to add SCA, at any time, by simply plugging in the appropriate module(s).

FCC approval of a system for quadraphonic FM will not obsolete the MS-15. Module positions exist which are ready to accept a quad generator.

DIGITALLY SYNTHESIZED MODULATION. The DSM stereo generator is a new development which eliminates the tradeoff that exists between switching type and balanced modulator types of stereo generators—poor separation at high frequencies in the former or poor harmonic rejection and SCA crosstalk in the latter. The DSM stereo generator is capable of both 50 dB separation (typical) through 15 kHz and an exceptionally clean baseband, promoting minimal interaction between stereo and SCA service. Also, pilot phase is automatically controlled so that high separation can be maintained under varying operating conditions.

OVERSHOOT COMPENSATION. A Dynamic Transient Response (DTR) filter has been developed by Harris for FM stereo, with overshoot no greater than 2% on any program material processed by any limiter. As a result, from 2 to 6 dB increased loudness can be achieved without degradation of audio quality. Controlled transient response, high stereo separation, low crosstalk, and low intermodulation distortion are all maintained with increased loudness. For monaural

stations wishing to protect 41 and/or 67 kHz SCA channels, a defeatable linear phase lowpass filter is provided for optimal linear control of overshoot.

COMPATIBILITY. The MS-15 exciter is mechanically and electrically compatible with the Harris TE-3 exciter. Mountings are in the same location and use the same hardware.

RF output power is 15 watts into 50 ohms, continuously adjustable to 3 watts by one control. A directional coupler samples and meters forward and reflected power, with remote metering capability. A harmonic filter is placed at the RF module output, reducing harmonics to a low level. The balanced 600 ohm audio input is transformerless to give maximum common mode rejection and excellent response. Inputs will withstand high transients or steady state voltages above or below ground reference.

The basic exciter audio response is wide-band and flat, and can be used directly with a studio-transmitter link. The exciter is self-contained, including the power supply.

OTHER FEATURES. The Harris MS-15 exciter can be quickly and easily programmed to any carrier frequency in the 87.5 to 108 MHz band in 50 kHz increments. The RF output network is broadband and requires no tuning. Carrier frequencies are generated through a digital synthesizer which is locked to a 10 MHz TCXO high stability frequency standard. The TCXO has improved crystal aging characteristics and does not require an oven. The synthesizer also provides outputs at 2.5, 5, 10, 15, 20 and 25 MHz for easy frequency comparison to the National Bureau of Standards WWV transmissions.

Pre-emphasis is selectable to 75, 50, 25 or 0 microseconds in either monophonic or stereophonic operation.

Remote control capability includes switching between stereo and mono, and selection of left, right, or left-plus-right inputs for monophonic operation.

SCA OPERATION. SCA operation is added to the exciter through a plug-in module. It is available with either stereo or mono operation; up to two channels can be added to mono exciters, or a single SCA used with stereo. Any channel between 25 kHz and 75 kHz can be used, although 41 kHz and 67 kHz are normally provided. Either frequency is selectable on the SCA channel card.

Pre-emphasis is selectable to 150, 75, 50 or 0 microseconds. The input audio is applied to a programmable lowpass filter, and the output of the SCA generator filtered so that 150 microseconds pre-emphasis can be used with no degradation of SCA to main channel crosstalk.

Each SCA module has a pair of audio inputs, one AC coupled for audio, and the other DC coupled for data and video transmission.

The subcarrier level is adjustable to provide from 1% to 30% composite baseband SCA injection. When an SCA subcarrier is turned on or off, an automatic composite level switcher noiselessly compensates for the change in baseband injection level. 100% peak modulation is maintained independent of SCA status.

EASE OF MAINTENANCE. The entire exciter is modular for ease of troubleshooting and maintenance. An extender card is provided to allow easy servicing. Extensive metering is provided, and LED status lights on the modules indicate various performance features.

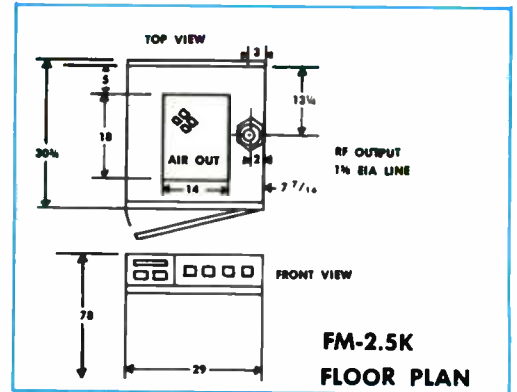
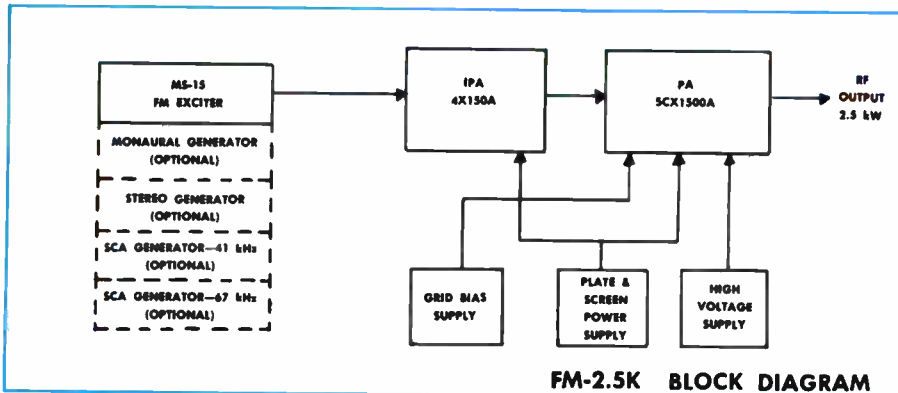

FM-2.5K SPECIFICATIONS

GENERAL

POWER OUTPUT: 800 W to 2.5 kW.
FREQUENCY RANGE: 87.5 to 108 MHz, tuned to specified operating frequency.
RF OUTPUT IMPEDANCE: 50 ohms.
OUTPUT TERMINATION: 1 1/2" EIA flange.
FREQUENCY STABILITY: ± 300 Hz 0° to 45° C TXCO.
TYPE OF MODULATION: Direct Carrier Frequency Modulation (DCFM).
MODULATION CAPABILITY: ± 100 kHz.
AC INPUT POWER: 197/250 V, 60 or 50 Hz, single phase, two wire.
 Power consumption: 4800 watts (approx.). 115/230 V, 60 or 50 Hz, 150 watts for MS-15.
RF HARMONICS: Suppression meets all FCC requirements.
POWER SUPPLY RECTIFIERS: Silicon.
ALTITUDE: 7500 feet.
AMBIENT TEMPERATURE RANGE: -20° C to $+45^\circ$ C.
MAXIMUM VSWR: 1.7 to 1.
OVERALL CABINET SIZE: 29"W (74cm) x 78"H (198cm) x 33"D (84cm).
FRONT DOOR SWING: 29" (74cm).
FINISH: White, blue and black.
WEIGHT & CUBAGE: Export: 1350 lbs. (612 kg). Domestic: 1100 lbs. (499 kg). 104 cu. ft. (2.9 cu. m).

MONAURAL MODE

AUDIO INPUT IMPEDANCE: 600 ohms balanced, resistive, adaptable to other impedances.
INPUT FILTER: Controlled response LPF, defeatable.
AUDIO INPUT LEVEL: $+10$ dBm ± 1 dB for 100% modulation at 400 Hz.
AUDIO FREQUENCY RESPONSE: Standard 75 microsecond FCC pre-emphasis curve ± 0.5 dB, 30-15,000 Hz. Selectable: flat, 25 or 50 microsecond pre-emphasis.
HARMONIC DISTORTION: 0.2% or less, 30-15,000 Hz.
IMD: 0.2%, 60/7000 Hz, 4:1 ratio.
FM NOISE: 68 dB below 100% modulation (ref. 400 Hz @ ± 75 kHz deviation).
AM NOISE: 50 dB below reference carrier AM modulation 100%.

STEREOPHONIC MODE

TYPE OF MODULATION: Digitally Synthesized Modulation (DSM).
AUDIO INPUT IMPEDANCE: (left and right) 600 ohms balanced, resistive. Adaptable to other impedances.
AUDIO INPUT LEVEL: (left and right) $+10$ dBm ± 1 dB for 100% modulation at 400 Hz.
AUDIO FREQUENCY RESPONSE: (left and right) Standard 75 microsecond, FCC pre-emphasis curve ± 0.5 dB 30-15,000 Hz. Selectable: flat, 25 or 50 microsecond pre-emphasis.
INPUT FILTERING: 15 kHz LPF, 45 dB rejection at 19 kHz.
OVERSHOOT PROTECTION: Dynamic transient response (DTR) filter.

AUDIO TRANSIENT RESPONSE: 2% maximum overshoot beyond steady state. Defeatable for test purposes.
HARMONIC DISTORTION: (left or right) 0.4% or less, 30-15,000 Hz.
IMD: 0.4%, 60/7000 Hz, 4:1 ratio.
FM NOISE: (left or right) 65 dB minimum below 100% modulation. Reference: 400 Hz, 75 microsecond de-emphasis, ± 75 kHz deviation.
PILOT OSCILLATOR: Crystal controlled.
PILOT STABILITY: 19 kHz ± 1 Hz, 0° to 45° C.
PILOT PHASE: Automatically controlled.
STEREO SEPARATION: 40 dB minimum 30-15,000 Hz.
CROSSTALK: (main to stereo sub-channel or stereo sub-to main channel) 45 dB below 90% modulation.
SUB CARRIER SUPPRESSION: 50 dB below 90% modulation.
76 kHz SUPPRESSION: 60 dB minimum below 100% modulation.
MODES: Stereo, mono (L + R), mono (L), mono (R). Remoteable.

SCA SPECIFICATIONS

MODULATION: Direct FM.
FREQUENCY: 41 or 67 kHz programable, any frequency between 25 and 75 kHz on special order.
FREQUENCY STABILITY: ± 500 Hz.
MODULATION CAPABILITY: ± 7.5 kHz.
AUDIO INPUT IMPEDANCE: 600 ohms balanced (AC coupled) and 2000 ohms unbalanced (DC coupled).
AUDIO INPUT LEVEL: $+10$ dBm ± 1 dB for 100% modulation at 400 Hz.
AUDIO FREQUENCY RESPONSE: 41 kHz and 67 kHz, 150 microsecond pre-emphasis ± 1 dB, standard. Selectable: flat, 50 or 75 microsecond pre-emphasis.
INPUT FILTERING: Programmable LPF, 4.5 kHz standard.
DISTORTION: Less than 1%, 30-5000 Hz. ± 5 kHz deviation.
FM NOISE: (main channel not modulated) 55 dB minimum (ref: 100% = ± 5 kHz deviation at 400 Hz).
CROSSTALK: (SCA to main or stereo sub-channel): -60 dB or better.
CROSSTALK: (main or stereo sub-channel to SCA): 50 dB below ± 5 kHz deviation of SCA, with mono or stereo channels modulated by frequencies 30-15,000 Hz, SCA demodulated with 150 microsecond de-emphasis.

CROSSTALK: SCA to SCA (41 kHz/67 kHz) 50 dB demodulated with 150 microsecond de-emphasis.
AUTOMATIC MUTE LEVEL: Variable from 0 to -30 dBm.
MUTE DELAY: Adjustable 0.5 to 20 seconds.
INJECTION LEVEL: 1% to 30% of composite. Adjustable.

WIDEBAND MODE

INPUT IMPEDANCE: Greater than 5000 ohms resistive, unbalanced.
INPUT LEVEL: 1.0 VRMS nominal for ± 75 kHz deviation.
AMPLITUDE RESPONSE: ± 0.25 dB, 30 Hz to 75 kHz.
PHASE LINEARITY: $\pm 2^\circ$, 30 Hz to 75 kHz.

ORDERING INFORMATION

FM-2.5K 2500 watt FM broadcast transmitter with MS-15 exciter, for wideband operation, 60 Hz	994-8047-001
As above, except 50 Hz	994-8047-003
100% spare tube kit	990-0587-001
Mono generator (add for mono operation)	994-8019-001
DSM stereo generator with DTR (add for stereo operation)	994-8020-001
SCA generator (add for SCA operation, specify 41 or 67 kHz)	994-7992-001



HARRIS

FM-1K

1-Kilowatt FM Broadcast Transmitter

- Solid-state Maximum Signal Exciter—MS-15
- Patented DSM Stereo Generator provides separation exceeding accurate measurement capability of most monitors
- DTR filter technique limits overshoot to 2% or less, permitting a 2 to 6 dB increase in loudness with no audio quality degradation
- Low operating cost
- Stable, easy output tuning
- Built-in connections for remote control
- Automatic recycling
- Full metering
- Plug-in mono, stereo and SCA generators





The FM-1K employs Harris' exclusive, advanced-design MS-15 solid-state exciter to provide the cleanest and the loudest FM signal of any one-kilowatt FM transmitter available today. The DSM (Digitally Synthesized Modulation) stereo generator allows the transmitter to provide stereo separation of 40 dB minimum, 30-15,000 Hz—while the DTR (Dynamic Transient Response) filter permits a 2 to 6 dB increase in loudness, with no degradation of audio quality, by limiting overshoot to 2% or less.

ONE TUBE DESIGN. Just one tube—a 4CX1000A tetrode—is all that is needed to supply 1000 watts output in the FM-1K. Driven directly by the MS-15 exciter, the 4CX1000A serves as the power amplifier and is operated well within its ratings for long tube life.

PLUG-IN MONO, STEREO AND SCA GENERATORS. The FM-1K may be equipped for mono or stereo operation, with or without SCA. The design versatility of the exciter allows you to order for mono

operation originally, then add stereo and/or SCA at a later date by plugging the appropriate module(s) into the exciter.

STABLE, EASY OUTPUT TUNING. Plate tuning of the final amplifier is stable and easily adjusted. The plate circuit is a shorted one-quarter wavelength configuration, with the plate-line operated at DC ground potential. Coarse plate tuning is preset for the operating frequency on the quarter-wave tank circuit. Fine adjustment is made with the plate tuning knob on the front panel. Amplifier loading is changed by a variable output loading capacitor.

POWER OUTPUT CONTROL. The transmitter's output loading control is motor-driven for smooth power adjustments, either locally or from a remote point. This feature allows the screen voltage of the 4CX1000A to be Zener-diode regulated for exceptional operating stability and tube life.

HARMONIC FILTERS STANDARD. Supplied with a Harris-designed multi-

section harmonic filter, the transmitter fully meets FCC requirements for spurious radiation. The second harmonic shorting stub is mounted inside the transmitter cabinet, leaving the easy-to-install low-pass in-line filter as the only external component.

AUTOMATIC RECYCLING. In case of momentary overload, the transmitter recycles automatically. Should the overload reoccur in excess of the desired number of times preset in the transmitter, the FM-1K will then remain off the air until it is reset, either locally or by remote control.

REMOTE CONTROL. All necessary operating functions can be remote controlled. No additional equipment is required to adapt a Harris remote control system to the transmitter. Connections are easily and simply made at a terminal strip in the cabinet.

TESTING. Environmental tests, in conditions surpassing those of any location a transmitter is likely to encounter, have been imposed on the FM-1K. The transmitter is capable of operating at altitudes up to 10,000 feet (3000 meters), in an ambient temperature range of -20° to $+45^{\circ}$ C.

In addition, your FM-1K is fully tuned and operationally tested on your frequency before shipment.

FULL METERING. Six meters, including four large, front-panel meters, provide full monitoring of the transmitter's operating parameters. Included is a power indicator that permits direct reading of both power output and standing wave ratio.

GENERAL. There are many other operational and convenience features incorporated into the FM-1K. These include:

Pushbutton Operation—On-off functions are controlled by lighted pushbuttons at the top left of the transmitter. These are clearly marked "Filament On-Off", "Plate On-Off".

High-Capacity Blower—backed up by a precision air-pressure switch, gives complete protection to the final amplifier tube.

Straightforward Design—allows easy accessibility to all components.

Handsome Styling—the transmitter cabinet is attractively yet functionally styled, and features a white and blue finish, with a black meter panel.

FCC Type Acceptance—the FM-1K is FCC type accepted for mono or stereo broadcasting in the 87.5 to 108 MHz FM band.

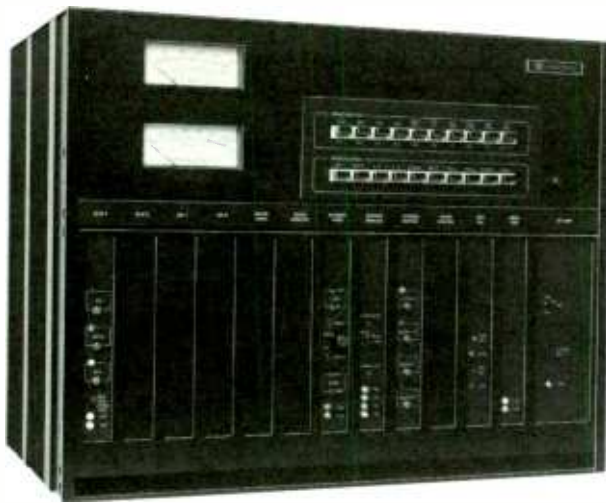

HARRIS' MS-15 . . . THE MOST ADVANCED FM EXCITER IN THE INDUSTRY

The solid-state MS-15 exciter employs Digitally Synthesized Modulation, overshoot compensation, and other exclusive design techniques, to give you an FM sound that is noticeably cleaner, noticeably louder than any competitive signal. The exciter is available for mono or stereo operation, with or without SCA. The modular construction of the MS-15 allows you to change the mode of operation, or to add SCA, at any time, by simply plugging in the appropriate module(s).

FCC approval of a system for quadrasonic FM will not obsolete the MS-15. Module positions exist which are ready to accept a quad generator.

DIGITALLY SYNTHESIZED MODULATION. The DSM stereo generator is a new development which eliminates the tradeoff that exists between switching type and balanced modulator types of stereo generators—poor separation at high frequencies in the former or poor harmonic rejection and SCA crosstalk in the latter. The DSM stereo generator is capable of both 50 dB separation (typical) through 15 kHz and an exceptionally clean baseband, promoting minimal interaction between stereo and SCA service. Also, pilot phase is automatically controlled so that high separation can be maintained under varying operating conditions.

OVERSHOOT COMPENSATION. A Dynamic Transient Response (DTR) filter has been developed by Harris for FM stereo, with overshoot no greater than 2% on any program material processed by any limiter. As a result, from 2 to 6 dB increased loudness can be achieved without degradation of audio quality. Controlled transient response, high stereo separation, low crosstalk, and low intermodulation distortion are all maintained with increased

loudness. For monaural stations wishing to protect 41 and/or 67 kHz SCA channels, a defeatable linear phase lowpass filter is provided for optimal linear control of overshoot.

COMPATIBILITY. The MS-15 exciter is mechanically and electrically compatible with the Harris TE-3 exciter. Mountings are in the same location and use the same hardware.

RF output power is 15 watts into 50 ohms, continuously adjustable to 3 watts by one control. A directional coupler samples and meters forward and reflected power, with remote metering capability. A harmonic filter is placed at the RF module output, reducing harmonics to a low level. The balanced 600 ohm audio input is transformerless to give maximum common mode rejection and excellent response. Inputs will withstand high transients or steady state voltages above or below ground reference.

The basic exciter audio response is wide-band and flat, and can be used directly with a studio-transmitter link. The exciter is self-contained, including the power supply.

OTHER FEATURES. The Harris MS-15 exciter can be quickly and easily programmed to any carrier frequency in the 87.5 to 108 MHz band in 50 kHz increments. The RF output network is broadband and requires no tuning. Carrier frequencies are generated through a digital synthesizer which is locked to a 10 MHz TCXO high stability frequency standard. The TCXO has improved crystal aging characteristics and does not require an oven. The synthesizer also provides outputs at 2.5, 5, 10, 15, 20 and 25 MHz for easy frequency comparison to the National Bureau of Standards WWV transmissions.

Pre-emphasis is selectable to 75, 50, 25 or 0 microseconds in either monophonic or stereophonic operation.

Remote control capability includes switching between stereo and mono, and selection of left, right, or left-plus-right inputs for monophonic operation.

SCA OPERATION. SCA operation is added to the exciter through a plug-in module. It is available with either stereo or mono operation; up to two channels can be added to mono exciters, or a single SCA used with stereo. Any channel between 25 kHz and 75 kHz can be used, although 41 kHz and 67 kHz are normally provided. Either frequency is selectable on the SCA channel card.

Pre-emphasis is selectable to 150, 75, 50 or 0 microseconds. The input audio is applied to a programmable lowpass filter, and the output of the SCA generator filtered so that 150 microseconds pre-emphasis can be used with no degradation of SCA to main channel crosstalk.

Each SCA module has a pair of audio inputs, one AC coupled for audio, and the other DC coupled for data and video transmission.

The subcarrier level is adjustable to provide from 1% to 30% composite baseband SCA injection. When an SCA subcarrier is turned on or off, an automatic composite level switcher noiselessly compensates for the change in baseband injection level. 100% peak modulation is maintained independent of SCA status.

EASE OF MAINTENANCE. The entire exciter is modular for ease of troubleshooting and maintenance. An extender card is provided to allow easy servicing. Extensive metering is provided, and LED status lights on the modules indicate various performance features.

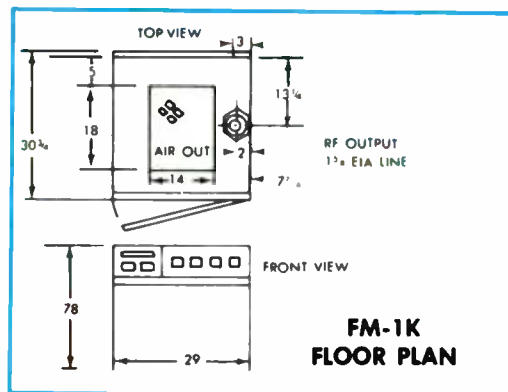
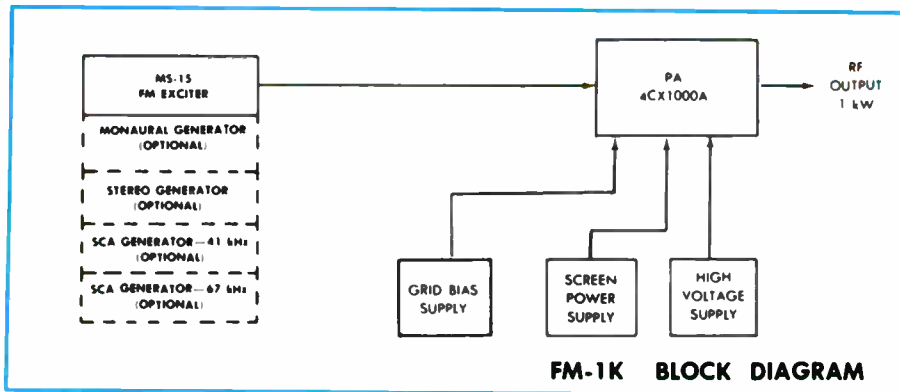

FM-1K SPECIFICATIONS

GENERAL

POWER OUTPUT: One kilowatt.
FREQUENCY RANGE: 87.5 to 108 MHz, tuned to specified operating frequency.
RF OUTPUT IMPEDANCE: 50 ohms.
OUTPUT TERMINATION: 1 1/2" EIA flange.
FREQUENCY STABILITY: ± 300 Hz 0° to 45° C TXCO.
TYPE OF MODULATION: Direct Carrier Frequency Modulation (DCFM).
MODULATION CAPABILITY: ± 100 kHz.
AC INPUT POWER: 208/240 V, 60 or 50 Hz, single phase, three wire. Power consumption: 2100 watts (approx.). 115/230 V, 60 or 50 Hz, 150 watts for MS-15.
RF HARMONICS: Suppression meets all FCC requirements.
POWER SUPPLY RECTIFIERS: Silicon.
ALTITUDE: 10,000 feet (3000 meters).
AMBIENT TEMPERATURE RANGE: -20° C to $+45^\circ$ C.
MAXIMUM VSWR: 1.7 to 1.
OVERALL CABINET SIZE: 29"W (74cm) x 78"H (198cm) x 33"D (84cm).
FRONT DOOR SWING: 29" (74cm).
FINISH: White, blue and black.
WEIGHT & CUBAGE: Export: 1300 lbs. (590 kg). Domestic: 1050 lbs. (476 kg). 104 cu. ft. (2.9 cu. m).

MONAURAL MODE

AUDIO INPUT IMPEDANCE: 600 ohms balanced, resistive, adaptable to other impedances.
INPUT FILTER: Controlled response LPF, defeatable.
AUDIO INPUT LEVEL: $+10$ dBm ± 1 dB for 100% modulation at 400 Hz.
AUDIO FREQUENCY RESPONSE: Standard 75 microsecond FCC pre-emphasis curve ± 0.5 dB, 30-15,000 Hz. Selectable: flat, 25 or 50 microsecond pre-emphasis.
HARMONIC DISTORTION: 0.2% or less, 30-15,000 Hz.
IMD: 0.2%, 60/7000 Hz, 4:1 ratio.
FM NOISE: 68 dB below 100% modulation (ref. 400 Hz @ ± 75 kHz deviation).
AM NOISE: 50 dB below reference carrier AM modulation 100%.

STEREOPHONIC MODE

TYPE OF MODULATION: Digitally Synthesized Modulation (DSM).
AUDIO INPUT IMPEDANCE: (left to right) 600 ohms balanced, resistive. Adaptable to other impedances.
AUDIO INPUT LEVEL: (left and right) $+10$ dBm ± 1 dB for 100% modulation at 400 Hz.
AUDIO FREQUENCY RESPONSE: (left and right) Standard 75 microsecond, FCC pre-emphasis curve ± 0.5 dB 30-15,000 Hz. Selectable: flat, 25 or 50 microsecond pre-emphasis.
INPUT FILTERING: 15 kHz LPF, 45 dB rejection at 19 kHz.
OVERSHOOT PROTECTION: Dynamic transient response (DTR) filter.
AUDIO TRANSIENT RESPONSE: 2% maximum overshoot beyond steady state. Defeatable for test purposes.

HARMONIC DISTORTION: (left or right) 0.4% or less, 30-15,000 Hz.
IMD: 0.4%, 60/7000 Hz, 4:1 ratio.
FM NOISE: (left or right) 65 dB minimum below 100% modulation. Reference: 400 Hz, 75 microsecond de-emphasis, ± 75 kHz deviation.
PILOT OSCILLATOR: Crystal controlled.
PILOT STABILITY: 19 kHz ± 1 Hz, 0° to 45° C.
PILOT PHASE: Automatically controlled.
STEREO SEPARATION: 40 dB minimum 30-15,000 Hz.
CROSSTALK: (main to stereo sub-channel or stereo sub-to-main channel) 45 dB below 90% modulation.
SUB CARRIER SUPPRESSION: 50 dB below 90% modulation.
76 kHz SUPPRESSION: 60 dB minimum below 100% modulation.
MODES: Stereo, mono (L + R), mono (L), mono (R). Remoteable.

SCA SPECIFICATIONS

MODULATION: Direct FM.
FREQUENCY: 41 or 67 kHz programable, any frequency between 25 and 75 kHz on special order.
FREQUENCY STABILITY: ± 500 Hz.
MODULATION CAPABILITY: ± 7.5 kHz.
AUDIO INPUT IMPEDANCE: 600 ohms balanced (AC coupled) and 2000 ohms unbalanced (DC coupled).
AUDIO INPUT LEVEL: $+10$ dBm ± 1 dB for 100% modulation at 400 Hz.
AUDIO FREQUENCY RESPONSE: 41 kHz and 67 kHz, 150 microsecond pre-emphasis ± 1 dB, standard. Selectable: flat, 50 or 75 microsecond pre-emphasis.
INPUT FILTERING: Programable LPF, 4.5 kHz standard.
DISTORTION: Less than 1%, 30-5000 Hz. ± 5 kHz deviation.
FM NOISE: (main channel not modulated) 55 dB minimum (ref: 100% = ± 5 kHz deviation at 400 Hz).
CROSSTALK: (SCA to main or stereo sub-channel): -60 dB or better.
CROSSTALK: (main or stereo sub-channel to SCA): 50 dB below ± 5 kHz deviation of SCA, with mono or stereo channels modulated by frequencies 30-15,000 Hz, SCA demodulated with 150 microsecond de-emphasis.
CROSSTALK: SCA to SCA (41 kHz/67 kHz) 50 dB demodulated with 150 microsecond de-emphasis.
AUTOMATIC MUTE LEVEL: Variable from 0 to -30 dBm.
MUTE DELAY: Adjustable 0.5 to 20 seconds.
INJECTION LEVEL: 1% to 30% of composite. Adjustable.

WIDEBAND MODE

INPUT IMPEDANCE: Greater than 5000 ohms resistive, unbalanced.
INPUT LEVEL: 1.0 VRMS nominal for ± 75 kHz deviation.
AMPLITUDE RESPONSE: ± 0.25 dB, 30 Hz to 75 kHz.
PHASE LINEARITY: $\pm 2^\circ$, 30 Hz to 75 kHz.

Specifications subject to change without notice.

ORDERING INFORMATION

FM-1K, 1 kW FM transmitter with MS-15 exciter, for wideband operation, 50/60 Hz.	994-8046-001
Mono generator (add for mono operation)	994-8019-001
DSM stereo generator with DTR (add for stereo operation)	994-8020-001
SCA generator (add for SCA operation, specify 41 or 67 kHz)	994-7992-001



HARRIS

FM-300K

Solid-State 300-Watt FM Transmitter

FM-300KD

Solid-State Main/Alternate 300-Watt FM Transmitter

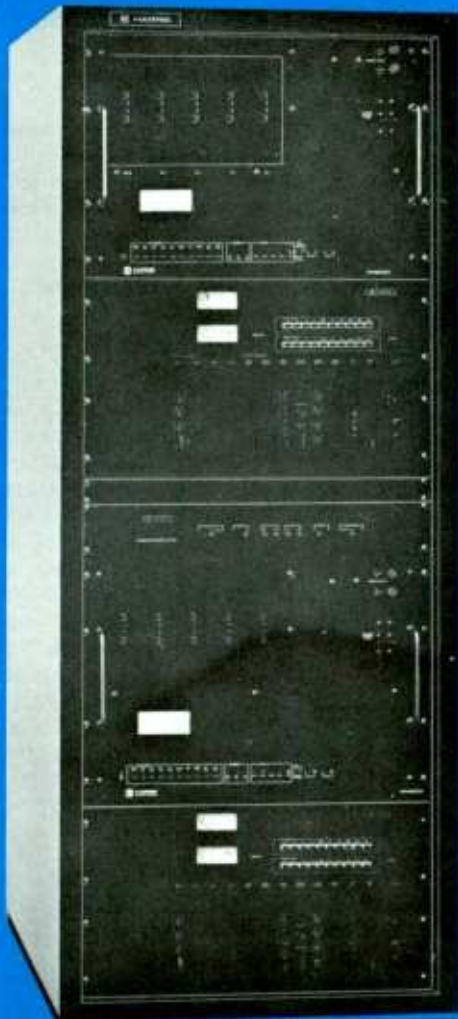

FM-300KD Main/Alternate Transmitter

- Advanced all solid-state design
- Final PA design allows continued operation should a PA module fail
- Advanced MS-15 Exciter yields minimum distortion for maximum signal clarity
- Digitally Synthesized Modulation (DSM) Stereo Generator provides maximum separation under all programming conditions, offering new stereo realism
- DTR Stereo Generator Filter* yields 2 to 6 dB increase in loudness without overmodulating
- Extensive status indicators and metering functions minimize costly maintenance and troubleshooting
- Modular construction permits rapid repairs, minimizing down time
- Complete redundancy in the FM-300KD for 100% back-up against off-air time

*Patented

Harris' 300-watt FM transmitter is available in two configurations—the standard model (FM-300K) and the main/alternate version (FM-300KD) with optional automatic changeover.

The FM-300KD is a completely redundant transmitter designed to give you total protection against off-air time. Consisting of two 300-watt FM transmitters and an optional automatic changeover panel mounted in a single 24-inch wide cabinet, the FM-300KD will automatically switch to the alternate transmitter in case of RF loss from the main unit. This configuration also allows you to perform transmitter maintenance during broadcast hours with no down time.

The FM-300K single transmitter is mounted in the same size cabinet as the FM-300KD, and the extra cabinet space may be utilized for monitoring and test equipment.

Both transmitters are 100% solid state for top reliability, and represent two of the first all-solid-state 300-watt broadband transmitters ever developed. Harris was the first equipment manufacturer to introduce an all-solid-state radio broadcast transmitter—the MW-1, one-kilowatt AM transmitter—and has been delivering these transmitters since early 1975. This solid-state transmitter engineering experience and technology has now been applied to Harris' 300-watt FM transmitters to bring you the most advanced design available anywhere.

The transmitters also incorporate such Harris-developed features as Digitally Synthesized Modulation (DSM) for the very finest stereo signal available; and the Dynamic Transient Response (DTR) filter, which holds overshoot on any program material to 2% or less. Additional features include automatic recycling; an air cooling system with replaceable dust filter; availability of two SCA channels; a wideband input for use with microwave studio-transmitter links; and modular design for ease of maintenance.

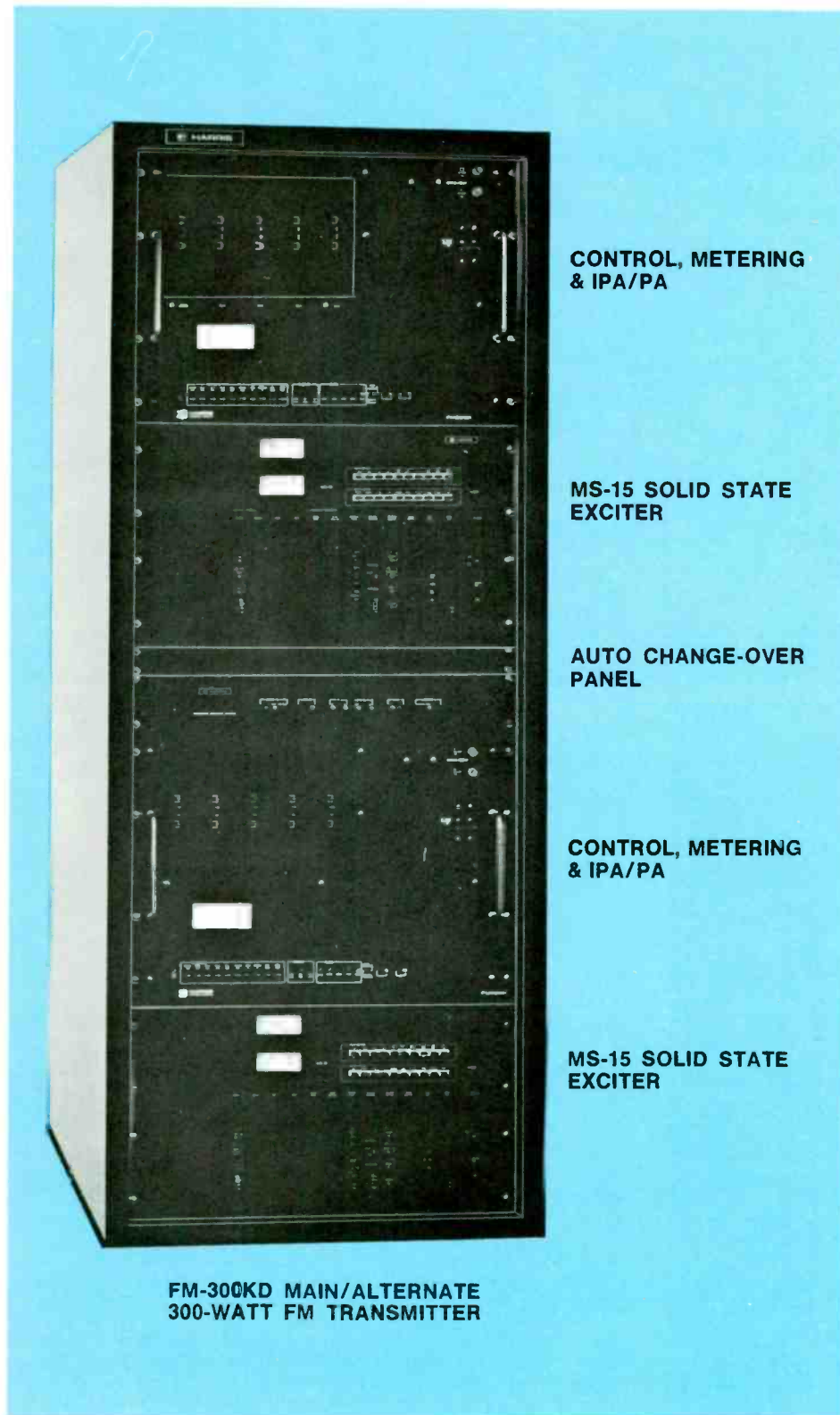

**FM-300KD MAIN/ALTERNATE
300-WATT FM TRANSMITTER**

**CONTROL, METERING
& IPA/PA**

**MS-15 SOLID STATE
EXCITER**

**AUTO CHANGE-OVER
PANEL**

**CONTROL, METERING
& IPA/PA**

**MS-15 SOLID STATE
EXCITER**

POWER AMPLIFIER (PA). The power amplifier consists of four modules, each module containing two transistor amplifiers in a highly efficient broadband amplifier circuit. Each module has an individual current protection circuit and voltage regulator. LED status lights indicate the condition of each amplifier. A front panel test point allows a measurement of relative RF power output with a DC voltmeter. The PA RF

broadband output combiner network allows the failure of an amplifier module without causing an off-air condition. Each module is rated at 100 watts, with transmitter power output 300 watts nominal.

INTERMEDIATE POWER AMPLIFIER (IPA). The IPA is identical to the PA modules, and can be interchanged with a PA module in

the event of an IPA failure for operation at reduced power. Optimum broadband matching of the input provides a low VSWR to the FM exciter over the entire FM band.

CONTROL CIRCUITS. Control function circuits are provided for transmitter turn on, AFC lock, RF mute, air flow, PA overload, and VSWR protection. Remote control interface is also provided. Status lights with memory are provided for VSWR and amplifier overloads. The transmitters are equipped for AC restart in case of a power failure while on the air.

AUTOMATIC RECYCLING. The recycle circuitry is self-clearing and uncomplicated. Should a momentary overload occur, the transmitter will recycle automatically. If the overload occurs in excess of the number of times pre-set, the transmitter will remain off the air until it is reset, either manually or by remote control.

HARMONIC FILTER. An internal (self-contained) harmonic filter is provided which assures compliance with RF harmonic output requirements. It allows coverage of the entire FM band.

DIRECTIONAL COUPLER. An internal directional coupler provides local and remote indication of both forward output power and reflected power. The reflected power section is connected to the control circuit for the purpose of initiating amplifier shutdown in the event of excessive VSWR. The forward power section initiates changeover to the spare amplifier after the output power drops to a pre-determined level (FM-300KD only).

POWER SUPPLY. The DC power supplies for the control circuits and amplifier modules are capable of operation from any conventional 200-260 VAC, 50/60 Hz single phase AC power supply. The PA RF amplifier modules are supplied by a feedback-type integrated circuit voltage regulator whose output is adjustable with a single front panel control. Each voltage regulator can operate with a continuous short on its output safely, without causing further damage, due to its current foldback capability. The IPA voltage regulator is also adjustable. Cooling is provided for regulator devices. Silicon power rectifiers are used throughout.

METERING. Ample transmitter metering is provided for functions including RF output, VSWR, PA DC input voltages and currents, IPA DC input voltage and current, and unregulated supply voltage. LED indicators on the IPA module and PA module front panels give indication of correct RF output for easy fault location.

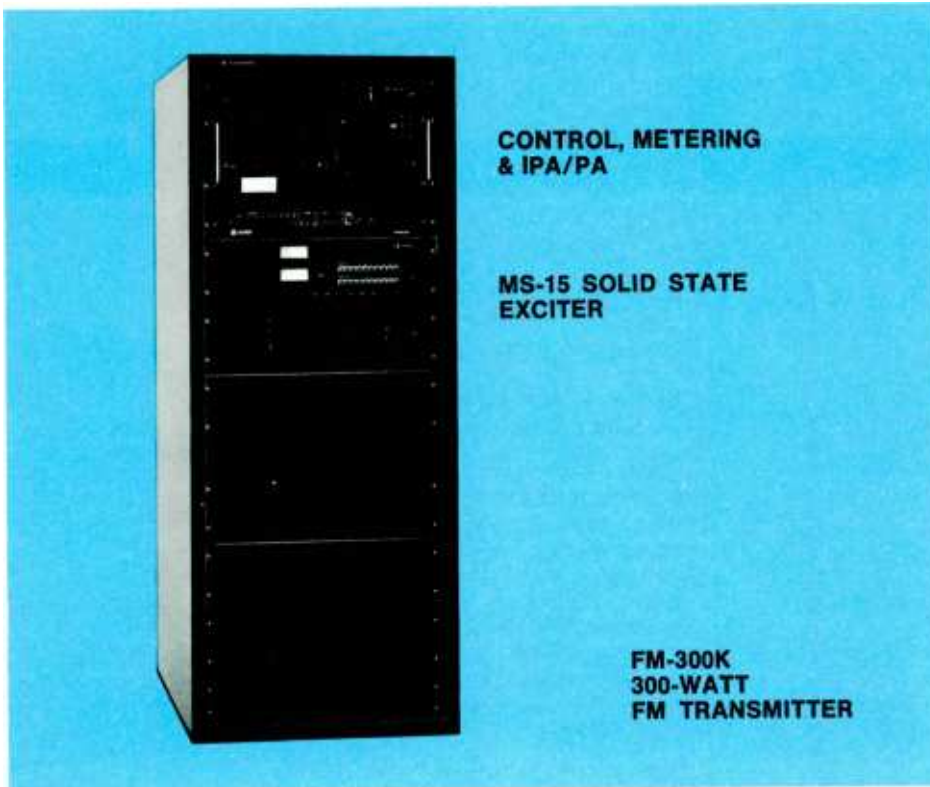

advanced development which eliminates the tradeoff that exists between switching type and balanced modulator types of stereo generators—poor separation at high frequencies in the former or poor harmonic rejection and SCA crosstalk in the latter. The DSM stereo generator is capable of both 50 dB separation (typical) through 15 kHz and an exceptionally clean baseband, promoting minimal interaction between stereo and SCA service. Also, pilot phase is automatically controlled so that high separation can be maintained under varying operating conditions.

OVERSHOOT COMPENSATION. A Dynamic Transient Response (DTR) filter has been developed by Harris for FM stereo, with overshoot no greater than 2% on any program material processed by any limiter. As a result, from 2 to 6 dB increased loudness can be achieved without degradation of audio quality. Controlled transient response, high stereo separation, low crosstalk, and low intermodulation distortion are all maintained with increased loudness. For monaural stations wishing to protect 41 and/or 67 kHz SCA channels, a defeatable linear phase low pass filter is provided for optimal linear control of overshoot.

SCA OPERATION. Up to two SCA channels can be added to monaural transmitters, or a single SCA channel added to a stereo transmitter through module(s) plugged into the exciter. Any channel between 25 kHz and 75 kHz can be used, although 41 kHz and 67 kHz are normally provided. Either frequency is selectable on the SCA channel card.

Pre-emphasis is selectable to 150, 75, 50 or 0 microseconds. The input audio is applied to a programmable lowpass filter, and the output of the SCA generator filtered so that 150 microseconds pre-emphasis can be used with no degradation of SCA to main channel crosstalk.

Each SCA module has a pair of modulation inputs, one balanced and AC coupled for audio, and the other DC coupled for data and video transmission.

The subcarrier level is adjustable to provide from 1% to 30% composite baseband SCA injection. When an SCA subcarrier is turned on or off, an automatic composite level switcher noiselessly compensates for the change in baseband injection level. 100% peak modulation is maintained independent of SCA status.

GENERAL. The MS-15 exciter RF output power is 3 to 15 watts into 50 ohms, continuously adjustable by one control. A di-

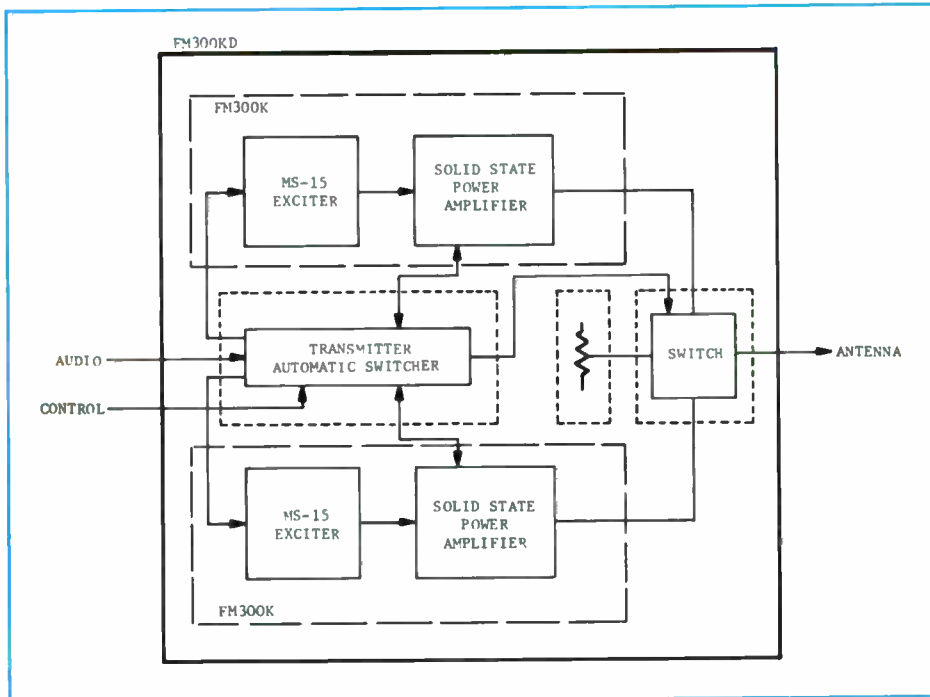

Block diagram of FM-300KD transmitter system, with optional equipment shown inside dotted lines.

QUALITY COMPONENTS. Every transmitter component is conservatively operated and chosen to give optimum performance in continuous duty service.

PLUG-IN MONO, STEREO AND SCA GENERATORS. The FM-300K and FM-300KD transmitters may be equipped for mono or stereo operation, with or without SCA. The design versatility allows you to order for mono operation originally, then add stereo

and/or SCA at a later date by plugging the appropriate module(s) into the exciter. Since the SCA generators have spectrally pure filtered outputs, 41 and 67 kHz SCA channels may be operated simultaneously while in the mono mode without harmonic interference.

DIGITALLY SYNTHESIZED MODULATION (DSM). The DSM stereo generator is an

rectional coupler samples and meters forward and reflected power, with remote metering capability. A harmonic filter is placed at the RF module output, reducing harmonics to a low level. The balanced 600 ohm audio input is transformerless to give maximum common mode rejection and excellent transient response. Inputs will withstand high transients or steady voltages above or below ground reference.

The transmitters can be quickly and easily programmed to any carrier frequency in the 87.5 to 108 MHz band in 50 kHz increments. Carrier frequencies are generated through a digital synthesizer which is locked to a 10 MHz TCXO high stability frequency standard. The TCXO has improved crystal aging characteristics and does not require an oven. The TCXO output may be conveniently and directly com-

pared with any one of several worldwide frequency standards.

EASE OF MAINTENANCE. The transmitters are modular for ease of trouble-shooting and maintenance. An extender card is provided to allow easy servicing. Extensive metering is provided, and LED status lights on the exciter modules indicate various performance features.

FM-300K/FM-300KD SPECIFICATIONS

GENERAL

POWER OUTPUT: 300 watts.

FREQUENCY RANGE: 87.5 to 108 MHz. Exciter programmable in 50 kHz increments. IPA and PA wideband.

RF OUTPUT IMPEDANCE: 50 ohms.

OUTPUT TERMINATION: Type N female.

FREQUENCY STABILITY: ± 300 Hz 0° to 45° C TCXO.

TYPE OF MODULATION: Direct Carrier Frequency Modulation (DCFM).

MODULATION CAPABILITY: ± 100 kHz.

AC INPUT POWER: 208 to 245 VAC, 50 or 60 Hz. Single phase, $\pm 5\%$ variation.

RF HARMONICS: 60 dB or better.

POWER SUPPLY RECTIFIERS: Silicon.

ALTITUDE: 12,000 ft. (3658 meters) maximum at rated ambient.

AMBIENT TEMPERATURE RANGE: 0° C to $+50^\circ$ C.

HUMIDITY: Up to 95% non-condensing.

MAXIMUM VSWR: 1.2 to 1.

OVERALL CABINET SIZE: Approx. $27\frac{3}{4}$ " W x $71\frac{3}{4}$ " H x $29\frac{3}{4}$ " D (70.5 cm x 182.3 cm x 75.6 cm).

FINISH: White, blue and black.

MONAURAL MODE

AUDIO INPUT IMPEDANCE: 600 ohms balanced, resistive, adaptable to other impedances.

INPUT FILTER: Controlled response LPF, defeatable.

AUDIO INPUT LEVEL: $+10$ dBm ± 1 dB for 100% modulation at 400 Hz.

AUDIO FREQUENCY RESPONSE: Standard 75 microsecond FCC pre-emphasis curve ± 0.5 dB, 30-15,000 Hz. Selectable: flat, 25 or 50 microsecond pre-emphasis.

HARMONIC DISTORTION: 0.2% or less, 30-15,000 Hz.

IMD: 0.2%, 60/7000 Hz, 4:1 ratio.

FM NOISE: 68 dB below 100% modulation (ref. 400 Hz @ ± 75 kHz deviation).

AM NOISE: 65 dB below reference carrier AM modulation 100%.

STEREOPHONIC MODE

TYPE OF MODULATION: Digitally Synthesized Modulation (DSM).

AUDIO INPUT IMPEDANCE: (Left to right) 600 ohms balanced, resistive. Adaptable to other impedances.

AUDIO INPUT LEVEL: (Left and right) $+10$ dBm ± 1 dB for 100% modulation at 400 Hz.

AUDIO FREQUENCY RESPONSE: (Left and right) Standard 75 microsecond, FCC pre-emphasis curve ± 0.5 dB 30-15,000 Hz. Selectable: flat, 25 or 50 microsecond pre-emphasis.

INPUT FILTERING: 15 kHz LPF, greater than 45 dB rejection at 19 kHz.

OVERSHOOT PROTECTION: Dynamic transient response (DTR) filter.

AUDIO TRANSIENT RESPONSE: 2% maximum overshoot beyond steady state. Defeatable for test purposes.

HARMONIC DISTORTION: (Left or right) 0.4% or less, 30-15,000 Hz.

IMD: 0.4%, 60/7000 Hz, 4:1 ratio.

FM NOISE: (Left or right) 65 dB minimum below 100% modulation. Reference: 400 Hz, 75 microsecond de-emphasis, ± 75 kHz deviation.

PILOT OSCILLATOR: Crystal controlled.

PILOT STABILITY: 19 kHz ± 1 Hz, 0° to 45° C.

PILOT PHASE: Automatically controlled.

STEREO SEPARATION: 40 dB minimum 30-15,000 Hz.

CROSSTALK: (Main to stereo sub-channel or stereo sub-to-main channel) 45 dB below 90% modulation.

SUB CARRIER SUPPRESSION: 60 dB below 90% modulation.

76 kHz SUPPRESSION: 60 dB minimum below 100% modulation.

MODES: Stereo, mono (L + R), mono (L), mono (R). Remoteable.

SCA SPECIFICATIONS

MODULATION: Direct FM.

FREQUENCY: 41 or 67 kHz programmable, any frequency between 25 and 75 kHz on special order.

FREQUENCY STABILITY: ± 500 Hz.

MODULATION CAPABILITY: ± 7.5 kHz.

AUDIO INPUT IMPEDANCE: 600 ohms balanced (AC coupled) and 2000 ohms unbalanced (DC coupled).

AUDIO INPUT LEVEL: $+10$ dBm ± 1 dB for 100% modulation at 400 Hz.

AUDIO FREQUENCY RESPONSE: 41 kHz and 67 kHz, 150 microsecond pre-emphasis ± 1 dB, standard. Selectable: flat, 50 or 75 microsecond pre-emphasis.

INPUT FILTERING: Programmable LPF, 4.5 kHz standard.

DISTORTION: Less than 1%, 30-4500 Hz. ± 5 kHz deviation.

FM NOISE: (Main channel not modulated) 55 dB minimum (Ref: 100% = ± 5 kHz deviation at 400 Hz).

CROSSTALK: (SCA to main or stereo sub-channel): -60 dB or better.

CROSSTALK: (Main or stereo sub-channel to SCA): 50 dB below ± 5 kHz deviation of SCA, with mono or stereo channels modulated by frequencies 30-15,000 Hz, SCA demodulated with 150 microsecond de-emphasis.

CROSSTALK: SCA to SCA (41 kHz/67 kHz) 50 dB demodulated with 150 microsecond de-emphasis.

AUTOMATIC MUTE LEVEL: Variable from 0 to -30 dBm.

MUTE DELAY: Adjustable 0.5 to 20 seconds.

INJECTION LEVEL: 1% to 30% of composite. Adjustable.

WIDEBAND MODE

INPUT IMPEDANCE: Greater than 5000 ohms resistive, unbalanced.

INPUT LEVEL: 1.0 VRMS nominal for ± 75 kHz deviation.

AMPLITUDE RESPONSE: ± 0.25 dB, 30 Hz to 75 kHz.

PHASE LINEARITY: $\pm 2^\circ$, 30 Hz to 75 kHz.

ORDERING INFORMATION

FM-300K, 300 Watt All Solid-State Transmitter—mounted in a 24" cabinet, for 50/60 Hz operation. 50 ohm type N female connector, equipped for wide band operation 994-8296-001

FM-300KD, Two Identical 300 Watt All Solid-State Transmitters—mounted in a single 24" cabinet, for 50/60 Hz operation, 50 ohm type N female output connectors. Equipped for wide band operation with STL 994-8297-001

Specifications subject to change without notice.



HARRIS

FM-100K

100 WATT FM TRANSMITTER

- Two separate configurations (transmitter, or stand alone 100 watt amplifier)
- Plug-in power amplifier module
- Extensive amplifier protection
- Feed Forward amplification
- Built-in redundancy
- Easy-to-read control and status indicators
- Amplifier can be driven with virtually any 10 watt exciter
- MS-15 exciter

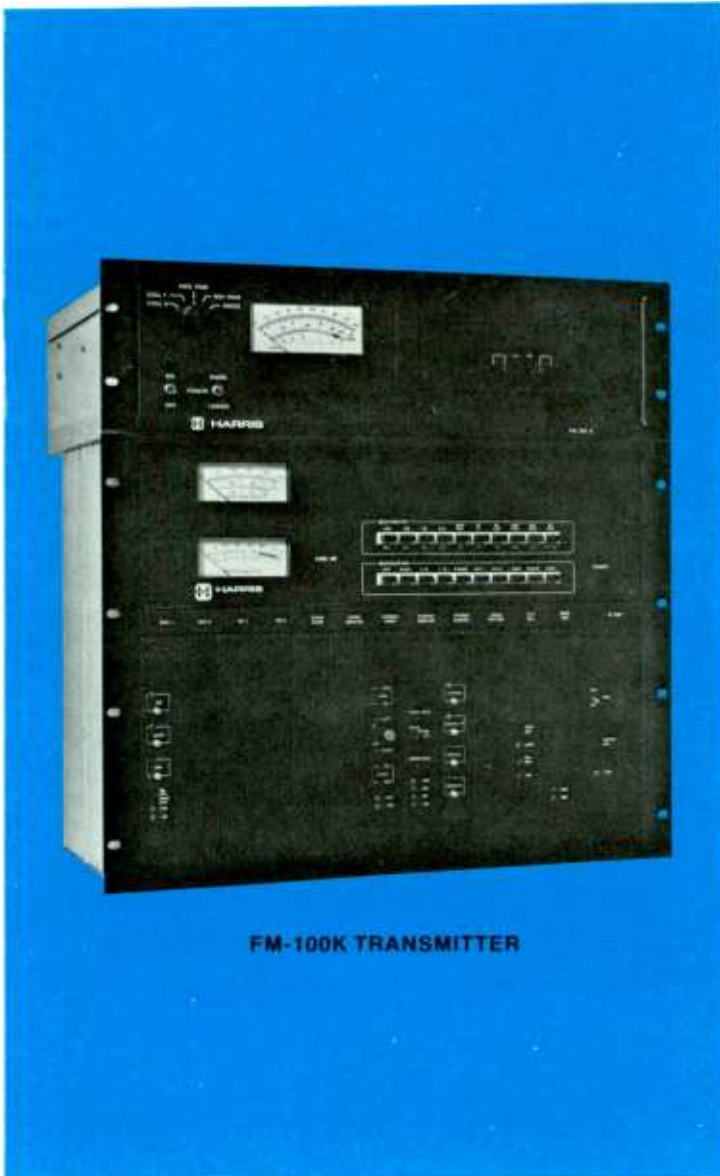

FM-100K TRANSMITTER

Two separate configurations give the Harris FM-100K flexibility to meet the needs of low power, Class D Educational broadcasters and International broadcasters requiring low power FM stations for broadcasting or program relay.

The standard FM-100K is a complete transmitter, incorporating the solid-state 100 watt broadband amplifier and the high-performance MS-15 exciter. The FM-100K 100 watt amplifier is available as a separate unit and can be driven with virtually any 10 watt exciter.

The FM-100K amplifier and MS-15 exciter both mount in a standard 19-inch equipment rack. Tolerating temperatures from 0°C. to 50°C., the complete transmitter is uniquely suitable for broadcasting environments and eliminates the need for heating or air conditioning equipment to maintain operating stability.

The amplifier can be driven with the MS-15 exciter or with most other exciters delivering 10 watts of power. Low power educational broadcasters desiring a power increase to Class A channel requirements will find this unit superbly suited to their needs. A simple connection to the existing 10 watt exciter/transmitter is all that's required.

PLUG-IN POWER AMPLIFIER MODULE

The heart of the FM-100K transmitter is the plug-in 100 watt amplifier module. This power module, providing reliable service in hundreds of worldwide installations, is the same one used in the field-proven Harris FM-300K and FM-25K transmitters. The module contains two RF transistors along with a common solid-state voltage regulator. The regulator controls collector voltage of the transistor stage, permitting continuous transmitter output power variance over a 10 to 100 watt range. By varying the collector voltage of the transistor stage rather than the RF drive, high PA efficiency is maintained over a wide output power adjustment range.

EXTENSIVE AMPLIFIER PROTECTION

The solid-state regulator performs several other important functions, including automatic current fold-back. Should a short develop in one of the transistors, the regulator senses excessive current draw and shuts down the amplifier. Should a fault occur, the automatic current fold-back feature limits excessive current and minimizes dissipation and resultant damage. The solid-state

HARRIS' FM-100K TRANSMITTER



Here a 10 watt signal is amplified by PA stage "B" to yield 55 watts. The 55 watts is asymmetrically split into a 45 watt and 10 watt signal. The 10 watt signal is further amplified by PA stage "A", while the 45 watt signal is fed forward through a delay compensation network to the output combiner. Hence the term "Feed Forward". Phase error between the two signals is eliminated by the delay compensation network, assuring proper output combining. The Harris Feed Forward Amplifier obtains 100 watts output power from 10 watts of drive signal.

BUILT-IN REDUNDANCY

Built-in redundancy gives the FM-100K amplifier a fail-safe capability. If an RF transistor fails, you can remain on the air at a reduced power of 55 watts by simply patching around the defective stage. Just unplug the printed circuit combiner board, rotate it 90°, and plug it back in. No clip leads to install; no wires to reposition.

CONTROL AND STATUS INDICATORS

From the large 4" front panel meter, you can quickly read five major operating parameters: PA collector voltage; PA collector current; forward power; VSWR; and input drive level. The RF amplifier module also incorporates two LED "go/no-go" status indicators monitoring each PA transistor.

Remote control provisions are built-in. Samples are provided for remote indication of collector voltage, collector current, and forward power. Remote on/off, along with raise and lower power, requires only momentary low current contact closure. This permits direct connection to most remote control systems, eliminating the cost of interface panels.

regulator also implements VSWR protection. Should a high antenna VSWR be detected by the built-in directional coupler, the voltage regulator automatically turns down the supply voltage to the amplifier.

FEED FORWARD AMPLIFICATION

The FM-100K utilizes a circuit called Feed Forward Amplification. Figure 1 shows in detail how the Feed Forward Amplifier works. The left block diagram depicts a conventional combiner configuration. Here a 20

watt input signal is split into equal 10 watt signals, which are amplified by PA stages into two 50 watt signals. These 50 watt signals are then combined to yield 100 watts. Unfortunately, in this conventional configuration 20 watts of drive signal is required for 100 watts output, precluding the use of most exciters as drivers.

Harris has devised a unique RF amplifier which resolves the problems of conventional combining, the Feed Forward Amplifier, shown in the right portion of figure 1.

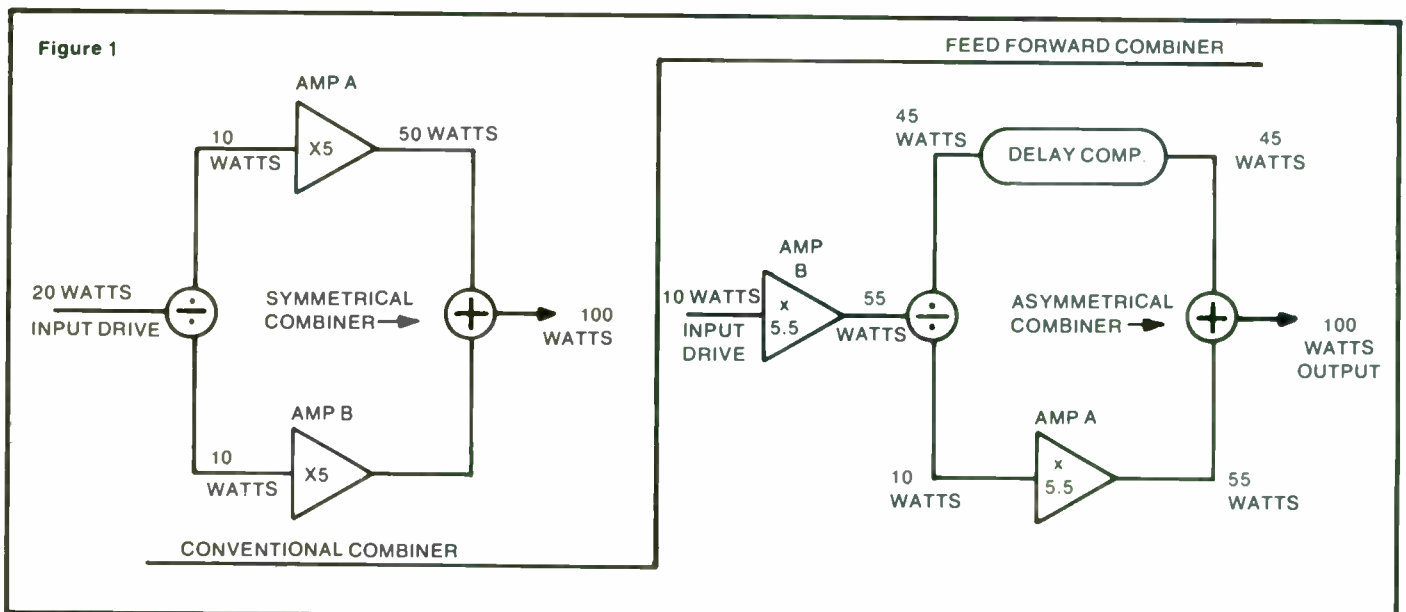

WITH FEED FORWARD AMPLIFICATION

MS-15 EXCITER

The Harris FM-100K transmitter is equipped with the high performance MS-15 exciter. The MS-15 exciter offers the broadcaster several features combining outstanding signal quality with high reliability.

GENERAL

The MS-15 mainframe is ruggedly constructed. A positive guidance system permits easy removal and reinsertion of all modules. All modules can be serviced from the front of the exciter using the supplied extender card.

Transformerless audio inputs are balanced to give maximum common mode rejection while maintaining excellent response. Inputs will withstand high transients or steady state voltages above or below ground reference. The basic exciter audio response is wideband and flat, and can be used without interface directly with a studio/transmitter link.

The exciter is configured to accept a plug-in quadrasonic FM generator, and provides metering of left and right rear audio inputs. All five competing quadrasonic systems currently under FCC consideration can be accommodated by the MS-15.

Status LED indicators are used throughout to aid in troubleshooting. Metering is provided to monitor 20 functions. A peak reading audio voltmeter aids in setting up the exciter on tones, and can serve as an accurate peak program indicator.

ULTRA-LINEAR VCO

The unique VCO of the MS-15 features superb linearity not found in conventional modulated oscillator designs. The 0.2% maximum monaural distortion specification is conservative; typical readings below this limit are not unusual. The importance of this ultra linearity can be easily seen. Non-linearities in any direct FM modulated oscillator severely limit stereo performance. No tuning adjustments are required. Performance is not compromised by complexity.

DIGITAL SYNTHESIZER

The MS-15 uses a 10 MHz TCXO high-stability reference oscillator and programmable divider chain in its dual-state phase locked loop AFC system. The synthesizer provides outputs at 2.5, 5, 10, 15, 20, and 25 MHz, permitting direct comparison against WWV transmissions on these frequencies. The synthesizer can be easily programmed to any carrier frequency in the 87.5 to 108 MHz band in 50 KHz increments. The dual-state AFC circuit will lock the VCO over a ± 10 MHz range in a maximum of 5 seconds, starting from an unlocked condition. Once locked, AFC passband is narrowed, improving FM signal to noise.



The high-performance MS-15 Exciter, above, and the FM-100K Amplifier utilize modular construction throughout for ease of service

POWER AMPLIFIER

The power amplifier module, conservatively rated at 15 watts output, requires no tuning across the entire FM band. The output is VSWR protected to prevent accidental damage to the PA.

PLUG-IN MONO, STEREO AND SCA GENERATORS

Harris' new, patented DSM stereo generator obsoletes switching and balanced modulator forms of stereo generation. The earlier types of stereo generation suffer from degraded separation at the lower and upper frequency limits (50 Hz and 15 KHz), and/or poor harmonic rejection resulting in degraded crosstalk. DSM has neither of these trade-offs. The result is the cleanest-sounding stereo performance of any FM exciter. Minimum separation is 40 dB from 30 to 15,000 Hz. Typically, separation will exceed 50 dB over this entire band. Since this exceeds guaranteed accuracy of most modulation monitors, only carefully calibrated test equipment can accurately measure the actual performance of the MS-15.

The high performance characteristics of the DSM generator are easily maintained year after year. Digital circuitry reduces user ad-

justments to a bare minimum, and adjustments are relatively non-critical in nature. An automatic pilot phase control makes it virtually impossible to misadjust this critical parameter.

OVERSHOOT COMPENSATION

A Dynamic Transient Response (DTR) filter, developed and patented by Harris for FM stereo, holds overshoot on any program material to 2% or less. As a result, from 2 to 6 dB increased loudness can be achieved with no degradation of audio quality. Controlled transient response, high stereo separation, low crosstalk and low intermodulation distortion are all maintained with increased loudness.

SCA OPERATION

Up to 2 optional SCA generators may be plugged into the exciter mainframe. A balanced 600 ohm input is provided for normal SCA program audio. A separate DC coupled wideband input to the exciter's direct FM modulator allows telemetry or data transmission where DC coupling is required. Crosstalk plagues many SCA generation systems under dynamic programming conditions, but is virtually inaudible in the MS-15 exciter system.

FM-100K TRANSMITTER SPECIFICATIONS

AMPLIFIER ONLY

FREQUENCY RANGE: 87.5-108 MHz
POWER OUTPUT: 100 watts
DRIVE REQUIREMENT FOR 100 WATT TPO: 10 watts
LINE VOLTAGE: 110-125 Vac (230 Vac 50-60 Hz available)
250 watts
PA EFFICIENCY: 55%
ALTITUDE: 3658 meters (12,000 feet)
TEMPERATURE: 0°C - 50°C ambient @ sea level (derate maximum operating temperature 2°C/1000 feet)
DIMENSIONS: 17" wide x 5¼" high x 15" deep
SHIPPING WEIGHT: Domestic - apx. 45¼ lbs (21 kg)
Export - apx. 57¼ lbs (26 kg)
HARMONIC SUPPRESSION: better than 66 dB
REMOTE CONTROL: standard
FM NOISE CONTRIBUTION: 1 dB Maximum¹
AM NOISE CONTRIBUTION: 3 dB Maximum¹
OUTPUT IMPEDANCE: 50 ohms (1.2:1 for full performance VSWR protected)
CONNECTORS: PA input and mod monitor sample - BNC
Output - N Connector
ACTIVE STAGES: 2 PA transistors
1 regulator
(1) To FCC type accepted 10 watt transmitter

FM-100K TRANSMITTER (EXCITER AND AMPLIFIER)

MONAURAL MODE

AUDIO INPUT IMPEDANCE: 600 ohms balanced, resistive, adaptable to other impedances
INPUT FILTER: Controlled response LPF, defeatable
AUDIO INPUT LEVEL: +10 dBm ± 1 dB for 100% modulation at 400 Hz
AUDIO FREQUENCY RESPONSE: Standard 75 microsecond FCC pre-emphasis curve +0.5 dB, 30-15,000 Hz. Selectable: flat, 25 or 50 microsecond pre-emphasis
HARMONIC DISTORTION: 0.2% or less, 30-15,000 Hz
IMD: 0.2%, 60/7000 Hz, 4:1 ratio
FM NOISE: 68 dB
AM NOISE: 55 dB

STEREOPHONIC MODE

TYPE OF MODULATION: Digitally Synthesized Modulation (DSM)
AUDIO INPUT IMPEDANCE: (Left to right) 600 ohms balanced, resistive. Adaptable to other impedances
AUDIO INPUT LEVEL: (Left and right) +10 dBm ± 1 dB for 100% modulation at 400 Hz
AUDIO FREQUENCY RESPONSE: (Left and right) Standard 75 microsecond FCC pre-emphasis curve +0.5 dB, 30-15,000 Hz. Selectable: flat, 25 or 50 microsecond pre-emphasis.
INPUT FILTERING: 15 kHz LPF, greater than 45 dB rejection at 19 kHz
OVERSHOOT PROTECTION: Dynamic transient response (DTR) filter
AUDIO TRANSIENT RESPONSE: 2% maximum overshoot beyond steady state. Defeatable for test purposes

HARMONIC DISTORTION: (Left or right) 0.4% or less, 30-15,000 Hz
IMD: 0.4%, 60/7000 Hz, 4:1 ratio
FM NOISE: (Left or right) 65 dB minimum below 100% modulation. Reference: 400 Hz, 75 microsecond de-emphasis, +75 kHz deviation
PILOT OSCILLATOR: Crystal controlled
PILOT STABILITY: 19 kHz ± 1 Hz, 0° to 45°C
PILOT PHASE: Automatically controlled
STEREO SEPARATION: 40 dB minimum 30-15,000 Hz
CROSSTALK: (Main to stereo sub-channel or stereo sub-to-main channel) 45 dB below 90% modulation
SUB CARRIER SUPPRESSION: 60 dB below 90% modulation
76 kHz SUPPRESSION: 60 dB minimum below 100% modulation
MODES: Stereo, mono (L + R), mono (L), mono (R). Remoteable

SCA SPECIFICATIONS

MODULATION: Direct FM
FREQUENCY: 41 or 67 kHz programmable, any frequency between 25 and 75 kHz on special order
FREQUENCY STABILITY: ± 500 Hz
MODULATION CAPABILITY: ± 7.5 kHz
AUDIO INPUT IMPEDANCE: 600 ohms balanced, (AC coupled) and 2000 ohms unbalanced (DC coupled)
AUDIO INPUT LEVEL: +10 dBm ± 1 dB for 100% modulation at 400 Hz
AUDIO FREQUENCY RESPONSE: 41 kHz and 67 kHz, 150 microsecond pre-emphasis ± 1 dB, standard. Selectable: flat, 50 or 75 microsecond pre-emphasis
INPUT FILTERING: Programmable LPF, 4.5 kHz standard
DISTORTION: Less than 1%, 30-4500 Hz. ± 5 kHz deviation
FM NOISE: (Main channel not modulated) 55 dB minimum (ref: 100% = ± 5 kHz deviation at 400 Hz)
CROSSTALK: (SCA to main or stereo sub-channel): -60 dB or better
CROSSTALK: (Main or stereo sub-channel to SCA): 50 dB below ± 5 kHz deviation of SCA, with mono or stereo channels modulated by frequencies 30-15,000 Hz, SCA demodulated with 150 microsecond de-emphasis
CROSSTALK: SCA to SCA (41 kHz/67 kHz) 50 dB demodulated with 150 microsecond de-emphasis
AUTOMATIC MUTE LEVEL: Variable from 0 to -30 dBm
MUTE DELAY: Adjustable 0.5 to 20 seconds
INJECTION LEVEL: 1% to 30% of composite. Adjustable

WIDEBAND MODE

INPUT IMPEDANCE: Greater than 5000 ohms resistive, unbalanced
INPUT LEVEL: 1.0 VRMS nominal for ± 75 kHz deviation
AMPLITUDE RESPONSE: ± 0.25 dB, 30 Hz to 75 kHz
PHASE LINEARITY: ± 2°, 30 Hz to 75 kHz
DIMENSIONS: 17.7" wide x 19¼" high x 15" deep
SHIPPING WEIGHT: Domestic - apx. 115¼ lbs (53 kg)

Specifications subject to change without notice

ORDERING INFORMATION

FM-100K Transmitter with MS-15 exciter for wideband operation	994-8453-001
100 Watt FM Amplifier	994-8453-002
Mono Module for mono operation	994-8019-001
DSM Stereo Generator for stereo operation	994-8020-001
SCA Generator for SCA operation (specify 41 and/or 67 KHz)	994-7992-001



HARRIS

MS-15

Maximum Signal FM Exciter

- Patented DSM Stereo Generator provides separation exceeding accurate measurement capability of most monitors
- DTR filter technique permits 2 to 6 dB loudness increase by eliminating overshoot
- Ultra linear VCO for minimum distortion
- Ovenless TCXO provides maximum stability
- System design virtually eliminates crosstalk into L-R and SCA channels under dynamic and steady state conditions
- Automatic pilot phase control and digital circuitry give long-term high performance
- MS-15--the first significant advance in FM excitors in over a decade

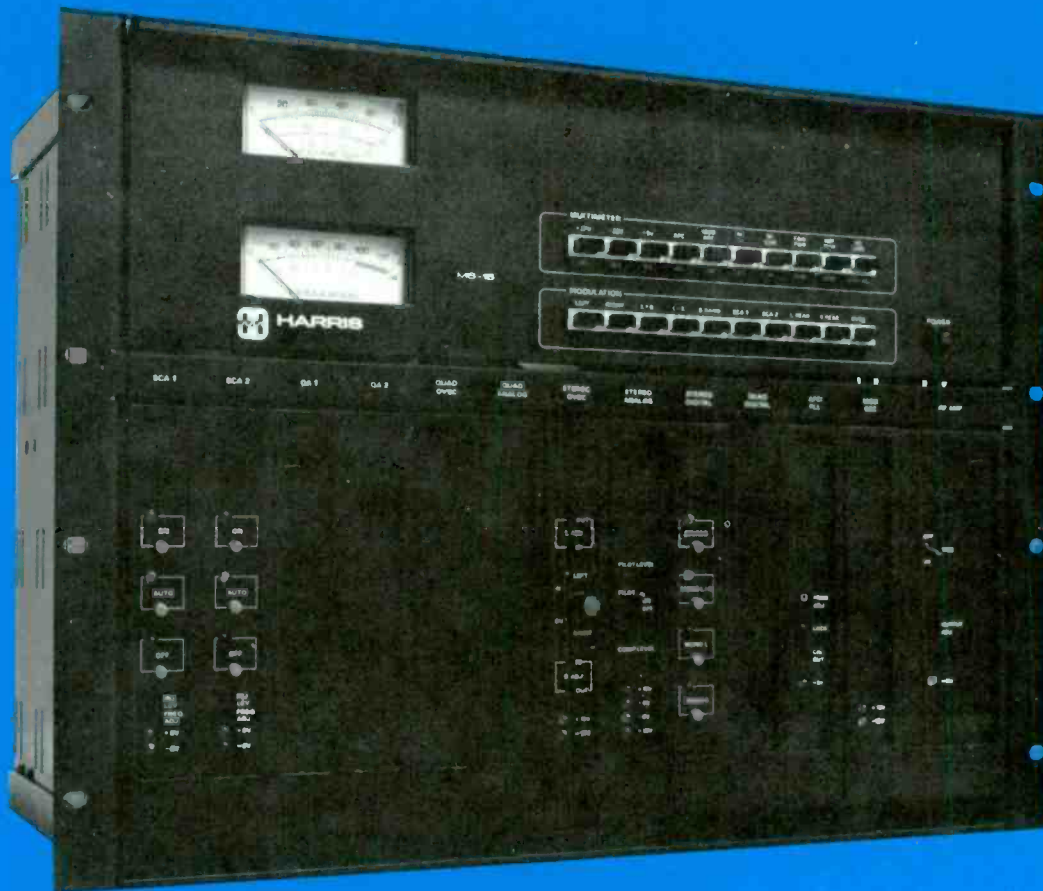

FM EXCITER IN THE INDUSTRY

a maximum of 5 seconds, starting from an unlocked condition. Once locked, the AFC passband is narrowed, maximizing FM signal to noise.

DIGITALLY SYNTHESIZED MODULATION.

The DSM stereo generator is a new, patented development that obsoletes switching and balanced modulator forms of stereo generation. While these earlier types of stereo generation suffer from degraded separation at the lower and upper frequency limits (50 Hz and 15 kHz), and/or poor harmonic rejection resulting in degraded crosstalk, DSM has neither of these trade-offs. This results in the cleanest-sounding stereo performance of any FM exciter. Minimum separation is 45 dB from 30 to 15,000 Hz and typically separation will exceed 50 dB over this entire band. Since this exceeds guaranteed accuracy of most modulation monitors, only carefully calibrated test equipment will be able to accurately measure the actual performance of the MS-15.

The high performance characteristics of the DSM generator are easy to maintain year after year. The digital circuitry employed reduces user adjustments to a bare minimum, and these are relatively non-critical in nature. An automatic pilot phase control makes it virtually impossible to misadjust this critical parameter.

OVERSHOOT COMPENSATION. A Dynamic Transient Response (DTR) filter was developed by Harris for FM stereo which holds overshoot on any program material to 2% or less. As a result, from 2 to 6 dB increased loudness can be achieved with no degradation of audio quality. Controlled transient response, high stereo separation, low crosstalk and low intermodulation distortion are all maintained with the increased loudness.

SCA OPERATION. Up to 2 optional SCA generators may be plugged into the exciter mainframe. A balanced 600 ohm input is provided for normal SCA program audio, and a separate DC coupled wideband input to the generator's direct FM modulator is provided for telemetry or data transmission where DC coupling is required. Crosstalk under dynamic programming conditions, which plagues many SCA generation systems, is virtually inaudible in the MS-15 exciter system.

POWER AMPLIFIER. The power amplifier module is conservatively rated at 15 watts output, and requires no tuning across the entire FM band. A lowpass filter with one tuning adjustment keeps RF harmonics to less than -53 dB. The output is VSWR protected to prevent accidental damage to the PA.

GENERAL. The MS-15 mainframe is

ruggedly constructed from interlocking aluminum extrusions. A positive guidance system permits easy removal and reinsertion of all modules. All modules can be serviced from the front of the exciter using the extender card supplied with the exciter.

Audio inputs are transformerless and balanced to give maximum common mode rejection while maintaining excellent response. Inputs will withstand high transients or steady state voltages above or below ground reference.

The basic exciter audio response is wideband and flat, and can be used, without interface, directly with a studio-transmitter link.

The exciter is configured to accept a plug-in quadraphonic FM generator and provides metering of Left and Right rear audio inputs. All of the five competing quadraphonic systems currently under consideration by the FCC can be accommodated by the MS-15.

Status LED indicators are used throughout to aid in troubleshooting. Metering is provided to monitor 20 functions. A peak reading audio voltmeter aids in setting up the exciter on tones, and can serve as an accurate peak program indicator.



The Harris DSM stereo generator, with digitally synthesized modulation, provides 45 dB stereo separation minimum, 30-15,000 Hz, and overshoot no greater than 2%.

GENERAL

MS-15 SPECIFICATIONS

POWER OUTPUT: 3W to 15W, continuously variable.
FREQUENCY RANGE: 87.5 to 108 MHz, tuned to specified operating frequency (programmable, 50 kHz channel spacing).
RF OUTPUT IMPEDANCE: 50 ohms, open and short circuit proof.
OUTPUT CONNECTION: BNC.
FREQUENCY STABILITY: ± 300 Hz 0° to 50°C , TCXO.
TYPE OF MODULATION: Direct Carrier Frequency Modulation (DCFM).
MODULATION CAPABILITY: ± 100 kHz.
AC INPUT POWER: 100 to 130 VAC or 200 to 260 VAC, 60 or 50 Hz, 150 W.
RF HARMONICS: Suppression meets all FCC requirements for 10 watt educational (53 dB).
POWER SUPPLY RECTIFIERS: Silicon.
ALTITUDE: 15,000 ft.
AMBIENT TEMPERATURE RANGE: 0°C to 50°C (operational to -20°C).
OVERALL CABINET SIZE: 17.7" W (44 cm) x 14"H (35 cm) x 12"D (30 cm). (19" rack mounting standard)
FINISH: Black
AUDIO/CONTROL CONNECTIONS: 2 x 18 pin barrier strips paralleled by 36 pin and socket connector.
MODULATION METER: 10 position, fast rise A/C metering (adjustable to meet FCC ballistics).
MULTIMETER: 10 position, DC metering.

MONAURAL MODE

AUDIO INPUT IMPEDANCE: 600 ohms balanced, resistive, adaptable to other impedances.
INPUT FILTER: Controlled response LPF, defeatable.
AUDIO INPUT LEVEL: +10 dBm ± 1 dB for 100% modulation at 400 Hz.
AUDIO FREQUENCY RESPONSE: Standard 75 microsecond FCC pre-emphasis curve ± 0.5 dB, 30-15,000 Hz. Selectable: flat, 25 or 50 microsecond pre-emphasis.
HARMONIC DISTORTION: 0.2% or less, 30-15,000 Hz.
IMD: 0.2%, 60/7000 Hz, 4:1 ratio.
FM NOISE: 68 dB below 100% modulation (ref. 400 Hz @ ± 75 kHz deviation, measured 30 Hz to 15 kHz with 75 microsecond de-emphasis).
AM NOISE: 70 dB below reference carrier AM modulation 100%, P out = 15 W.

STEREOPHONIC MODE

TYPE OF MODULATION: Digitally synthesized modulation (DSM).
AUDIO INPUT IMPEDANCE: (left and right) 600 ohms balanced, resistive. Adaptable to other impedances.
AUDIO INPUT LEVEL: (left and right) +10 dBm ± 1 dB for 100% modulation at 400 Hz.
AUDIO FREQUENCY RESPONSE: (left and right). Standard 75 microsecond, FCC pre-emphasis curve ± 0.5 dB 30-15,000 Hz. Selectable: flat, 25 or 50 microsecond pre-emphasis.
INPUT FILTERING: 15 kHz LPF, 45 dB rejection at 19 kHz.
OVERSHOOT PROTECTION: Dynamic transient response (DTR) filter.

AUDIO TRANSIENT RESPONSE: 2% maximum overshoot beyond steady state. Defeatable for test purposes.
HARMONIC DISTORTION: (left or right). 0.4% or less, 30-15,000 Hz. IMD: 0.4%, 60/7000 Hz, 4:1 ratio.
FM NOISE: (left or right) 65 dB minimum below 100% modulation. Reference: (400 Hz, 75 microsecond de-emphasis, ± 75 kHz deviation, measured 30 Hz to 15 kHz).
PILOT OSCILLATOR: Crystal controlled.
PILOT STABILITY: 19 kHz ± 1 Hz, 0° to 50°C .
PILOT PHASE: Automatically controlled.
STEREO SEPARATION: 45 dB minimum, 30-15,000 Hz.
DYNAMIC STEREO SEPARATION: 40 dB minimum under normal programming conditions.
CROSSTALK: (main to stereo sub-channel or stereo sub-to-main channel) 45 dB below 90% modulation.
SUB-CARRIER SUPPRESSION: 60 dB below 100% modulation.
76 kHz SUPPRESSION: 60 dB minimum below 100% modulation.
MODES: Stereo, mono (L + R) mono (L), mono (R). Remoteable.

SCA SPECIFICATIONS

MODULATION: Direct FM
FREQUENCY: 41 or 67 kHz programmable, any frequency between 25 and 75 kHz on special order.
FREQUENCY STABILITY: ± 500 Hz.
MODULATION CAPABILITY: ± 7.5 kHz.
AUDIO INPUT IMPEDANCE: 600 ohms balanced (AC coupled) and 2000 ohms unbalanced (DC coupled, BNC connections on rear panel).
AUDIO INPUT LEVEL: +10 dBm ± 1 dB for 100% modulation at 400 Hz.
AUDIO FREQUENCY RESPONSE: 41 kHz and 67 kHz, 150 microsecond pre-emphasis ± 1 dB, standard. Selectable: flat, 50 or 75 microsecond pre-emphasis.
INPUT FILTERING: Programmable LPF, 4.5 kHz standard.
DISTORTION: Less than 1%, 30-4,500 Hz. ± 5 kHz deviation.
FM NOISE: (Main channel not modulated) 55 dB minimum (ref: 100% = ± 5 kHz deviation at 400 Hz).
CROSSTALK: (SCA to main or stereo sub-channel); -60 dB or better.
CROSSTALK: (Main or stereo sub-channel to SCA); 50 dB below ± 5 kHz deviation of SCA, with mono or stereo channels modulated by frequencies 30-15,000 Hz, SCA demodulated with 150 microsecond de-emphasis.
CROSSTALK: SCA to SCA (41 kHz/67 kHz) 50 dB demodulated with 150 microsecond de-emphasis.
AUTOMATIC MUTE LEVEL: Variable from 0 to -30 dBm.
MUTE DELAY: Adjustable 0.5 to 20 seconds.
INJECTION LEVEL: 1% to 30% of composite. Adjustable.

WIDEBAND MODE

INPUT CONNECTOR: BNC.
INPUT IMPEDANCE: Greater than 5000 ohms resistive, unbalanced.
INPUT LEVEL: 1.0 VRMS nominal for ± 75 kHz deviation.
AMPLITUDE RESPONSE: ± 0.25 dB, 30 Hz to 75 kHz.
PHASE LINEARITY: $\pm 2^\circ$, 30 Hz to 75 kHz.

SPECIFICATIONS SUBJECT TO CHANGE WITHOUT NOTICE

ORDERING INFORMATION:

MS-15 exciter, for wideband operation, 19 inch rack mounted	994-7950-002
Mono option (add for mono operation)	994-8019-001
DSM stereo generator with DTR (add for stereo operation)	994-8020-001
SCA generator (add for SCA operation, specify 41 or 67 kHz)	994-7992-001



HARRIS

FMH SUPER-POWER CIRCULARLY POLARIZED FM ANTENNA

- High power handling capability
- Silver soldered internal feed point to each radiating element
- Multi-station capability
- Excellent bandwidth characteristics
- Rugged brass construction
- Silver plated inner-conductor connectors
- Radiused element tips to avoid corona problems
- Stainless steel support brackets and hardware
- Radiating element is machine extruded for added strength

The Harris super-power FMH circularly polarized FM antennas feature unusually high power handling capabilities, excellent bandwidth characteristics, and multi-station capability.

RADIATING ELEMENT. The radiating element is of brass construction, and has an outside diameter of 3- $\frac{1}{8}$ ". The silver soldered feed point is completely internal, with a pressurized environment up to the feed point. Each element is rated at 40 kW, with the exceptions of the "A" series end fed 1 and 2 bay antennas and the center fed 2 bay, which are rated at 32 and 39 kW respectively. Element ratings are limited only by the average power handling capability of the 3- $\frac{1}{8}$ " rigid coaxial line, which we have conservatively derated from 48 kW to 40 kW.

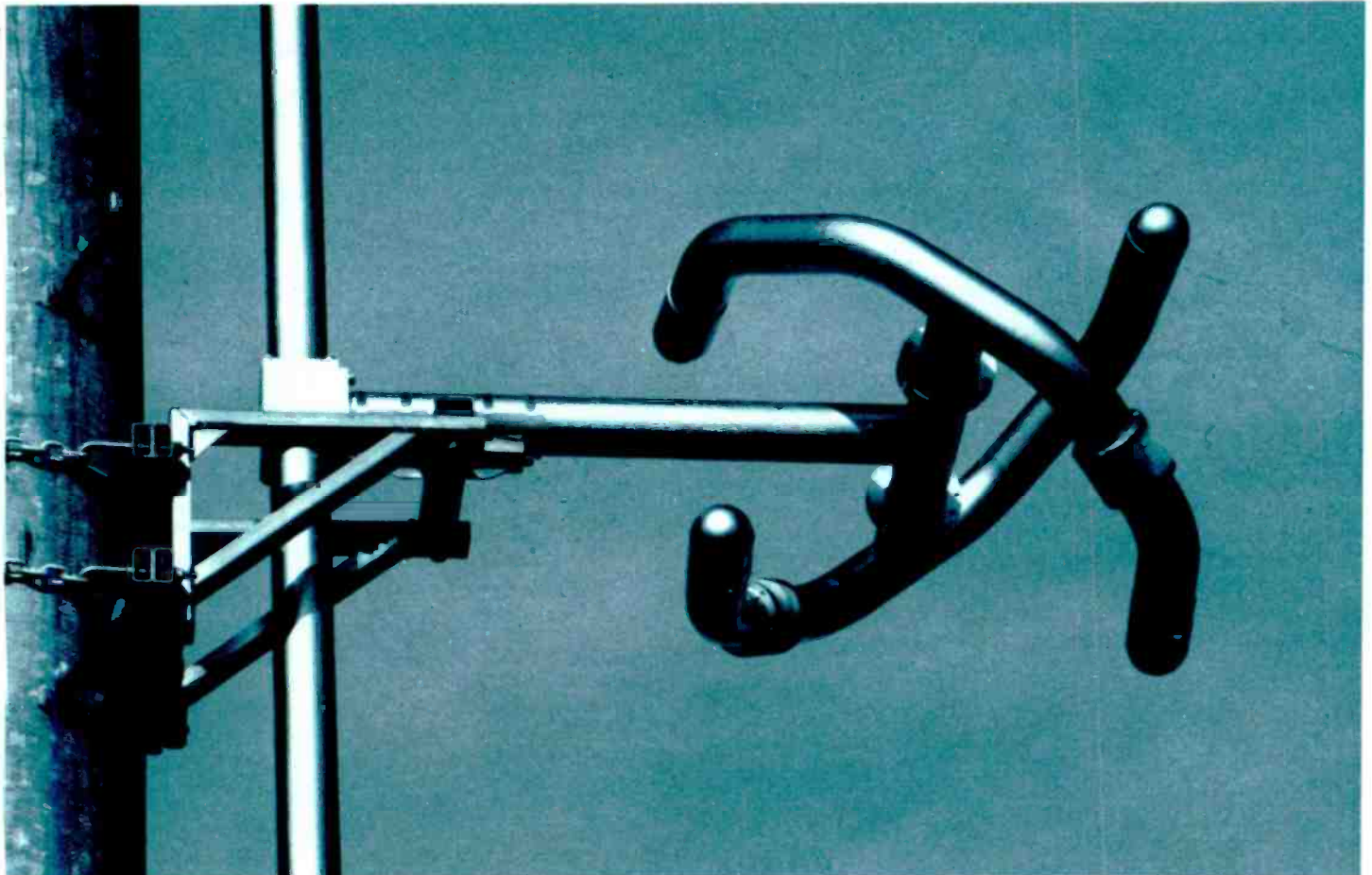

The rugged construction means these antennas will withstand the most severe weather extremes and wind velocities up to 150 miles per hour.

BANDWIDTH CAPABILITY. The FMH antenna has a low standing wave ratio of 1.07:1 or less, \pm 200 kHz per given channel with field trimming. VSWR at antenna input without field trimming is 1.2:1 for pole mounting atop a tower. VSWR at antenna input without field trimming is 1.5:1 or less when side mounted on a tower.

Due to the excellent bandwidth characteristics of the radiating element, multi-station operation is possible using a common antenna system. The necessary filtering components are available from Harris for such duplexing or multiplexing operations. Stations having a frequency separation of up to 4 MHz may be duplexed on a common antenna. However, in the case of 40 kW transmitters, a minimum frequency separation of 1.2 MHz is advisable to avoid excessive heating of filter components. Field tuning requiring multiple slug technology may be required for multiple station operation.

CIRCULARITY. The horizontally polarized radiation pattern is omni-directional when the antenna is pole mounted atop a tower, and circularity is typically \pm 2 dB when the antenna is mounted on a 14" diameter steel pole. When side mounted, the antenna pattern will be somewhat affected by the supporting structure.

DEICING. Deicers are not required in a normal environment, as the typical VSWR is 1.5:1 or less with 1/2-inch of radial ice. However, heaters for deicing and/or radomes are available at additional cost, and should be specified at time of purchase.

ANTENNA MODELS. The Harris FMH super-power FM antenna is available in three versions. The "A" version uses a 3-1/8" element feed stem, and 3-1/8" rigid interbay line. It is available in 3-1/8" end fed, 3-1/8" center fed and 6-1/8" center fed models, in arrays of up to 16 bays.

The FMH "B" version uses a 4-1/8" element feed stem, and a 4-1/8" rigid interbay line. It is available in either 6-1/8" end fed or 6-1/8" center fed models in arrays of up to 12 bays.

The FMH "C" version uses a 4-1/8" element feed stem, and 6-1/8" rigid interbay line, with 6-1/8" end feed. It is available in arrays of up to 6 bays.

Each antenna is supplied with a 6-foot input transformer. The input is 50 ohm EIA with either a 3-1/8" flange or a 6-1/8" flange, depending on the model type. All antennas are completely assembled and tuned to the customer's frequency at the factory. Also, pressure testing is done at that time to assure the customer of a leak-free antenna, provided the antenna is properly installed by a qualified erector and is free of damage.

MOUNTING. Stainless steel mounting brackets and hardware are supplied for standard constant cross section towers having less than 4 ft. face or steel poles at no additional cost. Brackets for mounting on tapered towers are available at additional cost.

DIMENSIONS. Each FMH element is approximately 47-1/2 inches long, and 30 inches high. Weight is approximately 57 pounds per element with line block.

MODEL NUMBERS. Because of the many variations within each FMH model category, it is helpful in ordering to understand the Harris model numbers:

FMH-1BE	FMH-4AC6
1 = 1 bay	4 = 4 bay
B = "B" Model	A = "A" Model
E = End Fed	C = Center Fed
	6 = 6-1/8" input

"A" Model, 3-1/8" Interbay Line, 3-1/8" Element Stem

TYPE NO.	POWER GAIN ¹		FEMALE 50 OHM INPUT	POWER ² INPUT CAPABILITY	CALCULATED WT. [LBS]	CALCU- ³ LATED WIND-LOAD [LBS]
	POWER	dB				
FMH-1AE	0.4611	-3.3623	3 1/8"	32kW	114	137
FMH-2AE	0.9971	-0.0128	3 1/8"	32kW	225	304
FMH-2AC	0.9971	-0.0128	3 1/8"	39kW	250	319
FMH-2AC6	0.9971	-0.0128	6 1/8"	64kW	301	421
FMH-3AE	1.5888	1.9278	3 1/8"	32kW	336	470
FMH-4AE	2.1332	3.2903	3 1/8"	32kW	447	637
FMH-4AC	2.1332	3.2903	3 1/8"	39kW	472	652
FMH-4AC6	2.1332	3.2903	6 1/8"	64kW	523	758
FMH-5AE	2.7154	4.3384	3 1/8"	32kW	558	804
FMH-6AE	3.3028	5.1888	3 1/8"	32kW	669	971
FMH-6AC	3.3028	5.1888	3 1/8"	39kW	694	986
FMH-6AC6	3.3028	5.1888	6 1/8"	64kW	745	1096
FMH-7AE	3.8935	5.9034	3 1/8"	32kW	780	1138
FMH-8AE	4.4872	6.5197	3 1/8"	32kW	891	1305
FMH-8AC	4.4872	6.5197	3 1/8"	39kW	916	1320
FMH-8AC6	4.4872	6.5197	6 1/8"	64kW	967	1433
FMH-10AC	5.6800	7.5435	3 1/8"	39kW	1138	1653
FMH-10AC6	5.6800	7.5435	6 1/8"	64kW	1189	1770
FMH-12AC	6.8781	8.3747	3 1/8"	39kW	1360	1987
FMH-12AC6	6.8781	8.3747	6 1/8"	64kW	1411	2108

"B" Model, 4-1/8" Interbay Line, 4-1/8" Element Stem

TYPE NO.	POWER GAIN ¹		FEMALE 50 OHM INPUT	POWER ² INPUT CAPABILITY	CALCULATED WT. [LBS]	CALCU- ³ LATED WIND-LOAD [LBS]
	POWER	dB				
FMH-1BE	0.4611	-3.3623	6 1/8"	40kW	159	201
FMH-2BE	0.9971	-0.0128	6 1/8"	56kW	297	407
FMH-2BC	0.9971	-0.0128	6 1/8"	80kW	336	468
FMH-3BE	1.5888	1.9278	6 1/8"	56kW	435	613
FMH-4BE	2.1332	3.2903	6 1/8"	56kW	573	818
FMH-4BC	2.1332	3.2903	6 1/8"	112kW	612	879
FMH-5BE	2.7154	4.3384	6 1/8"	56kW	711	1024
FMH-6BE	3.3028	5.1888	6 1/8"	56kW	849	1229
FMH-6BC	3.3028	5.1888	6 1/8"	112kW	888	1290
FMH-7BE	3.8935	5.9034	6 1/8"	56kW	987	1435
FMH-8BE	4.4872	6.5197	6 1/8"	56kW	1125	1641
FMH-8BC	4.4872	6.5197	6 1/8"	112kW	1164	1702
FMH-10BC	5.6800	7.5435	6 1/8"	112kW	1440	2113
FMH-12BC	6.8781	8.3747	6 1/8"	112kW	1716	2524

"C" Model, 6-1/8" Interbay Line, 4-1/8" Element Stem

TYPE NO.	POWER GAIN ¹		FEMALE 50 OHM INPUT	POWER ² INPUT CAPABILITY	CALCULATED WT. [LBS]	CALCU- ³ LATED WIND-LOAD [LBS]
	POWER	dB				
FMH-1CE	0.4611	-3.3623	6 1/8"	40kW	205	260
FMH-2CE	0.9971	-0.0128	6 1/8"	80kW	410	520
FMH-3CE	1.5888	1.9278	6 1/8"	120kW	615	780
FMH-4CE	2.1332	3.2903	6 1/8"	120kW	820	1040
FMH-5CE	2.7154	4.3384	6 1/8"	120kW	1025	1300
FMH-6CE	3.3028	5.1888	6 1/8"	120kW	1230	1560

FOOTNOTES-(Apply to all models)

1. Horizontal and vertical power gain and dB gain are the same. 2. Power input capability up to 2,000 ft. above mean sea level. Derating required above 2,000 ft. 3. Windload based on 50/33 PSF. 112 m.p.h. actual wind velocity. NOTE: Brackets included in weight and windload calculations.



HARRIS

FML LOW POWER CIRCULARLY POLARIZED FM ANTENNA

- Radomes or deicers not needed in most environments - eliminates associated maintenance and operating costs.
- Excellent bandwidth minimizes VSWR problems.
- Rugged brass element construction with stainless steel support brackets impedes corrosion.
- Wide power input rating permits flexibility in transmitting system design.

The Harris low power FML circularly polarized FM antenna features excellent bandwidth characteristics and the same rugged construction as Harris' higher-power FM antennas.

RADIATING ELEMENT. The radiating element of the FML antenna is of brass tubular construction, with an outside diameter of 1- $\frac{3}{4}$ inches. The feed point is completely internal, with a pressurized environment up to the feed point.

ANTENNA MODELS. Two versions of the FML are available. The "E" version is an end fed model mounted on 1- $\frac{5}{8}$ inch, 50 ohm rigid line. The "C" version is center fed, and uses 3- $\frac{1}{8}$ inch, 50 ohm rigid line.

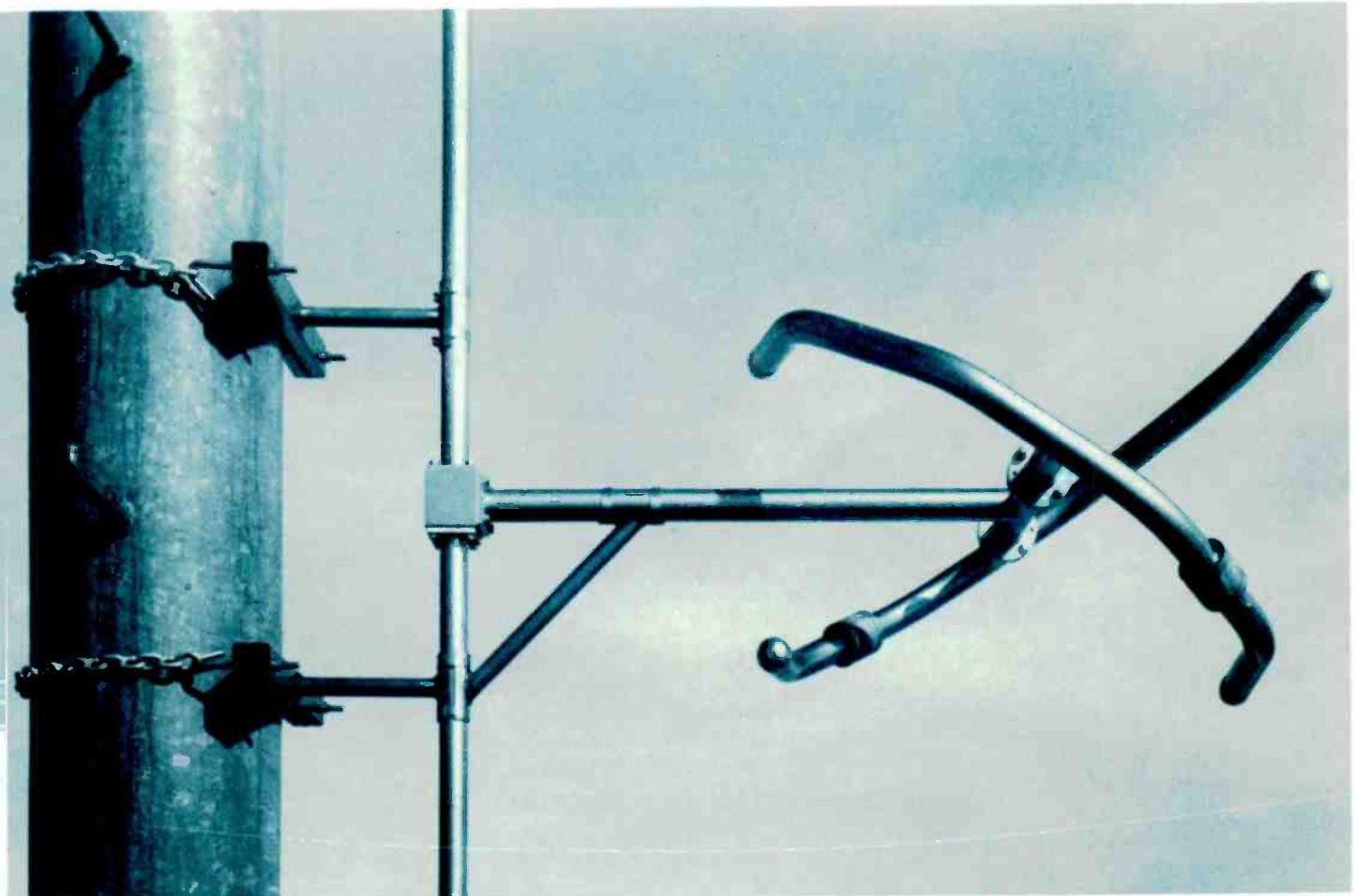

End fed models have a power input capability of 9 kW, limited by the average power capability of the 1- $\frac{1}{8}$ inch rigid coaxial line, which we have conservatively derated from 15 kW to 9 kW. The center fed versions have a power input capability of 12 kW with the 3- $\frac{1}{8}$ inch input feed. Each antenna comes with a 6 foot input transformer. The antenna system feed point is 6 feet below the bottom bay for end fed models, and approximately 6 feet below the center of the antenna for center fed antenna systems. The input is standard 1- $\frac{1}{8}$ inch EIA female flange for end fed models, and 3- $\frac{1}{8}$ inch EIA female flange for center fed models.

The element stem is of heavy wall brass tubing assuring that the element will withstand rugged environmental conditions.

RADIATION PATTERN. Complete antenna patterning facilities are available for measuring the antenna radiation patterns. An electrically equivalent full size tower section, approximately 20 feet long, is set up on the antenna range. The exact size and location of the ladder, coaxial transmission lines, conduits and cables are duplicated on this tower section, and an identical antenna element is mounted on the tower for such measurements.

Pattern optimization for the vertical polarization component, or both vertical and horizontal polarization components is available to improve the pattern circularity. Antenna pattern measurement and optimization is at additional cost.

BANDWIDTH CAPABILITY. The FML antenna has a low standing wave ratio of 1.1:1 or less, \pm 200 kHz per given channel with field trimming. VSWR at antenna input, without field trimming is 1.2:1 for pole mounting atop a tower. VSWR at antenna input, without field trimming, is 1.5:1 or less, when side mounted on a tower.

CIRCULARITY. The horizontally polarized radiation pattern is omnidirectional when the antenna is pole mounted, and circularity is typically \pm 2 dB when the antenna is mounted on a 14 inch diameter steel pole. When side mounted, the antenna pattern will be affected by the structure.

LOW VSWR. The typical VSWR of the FML antenna with $\frac{1}{2}$ inch of radial ice is 1.5:1, or less, thus almost totally eliminating the need for deicers. Only in extremely cold mountainous environments experiencing several inches of radial ice on antenna elements would the FML antenna encounter VSWR problems. For areas experiencing over $\frac{1}{2}$ inch of radial ice, radomes are offered to prevent excessive VSWR during severe icing conditions.

CONSTRUCTION. The radiating element and support stem are of brass tubular construction, using thick wall brass in the support stem. This provides a rugged construction capable of survival under severe weather extremes and with wind velocities up to 150 miles per hour (90 lbs. per square foot on flat members, 60 lbs. per square foot on cylindrical members).

Each antenna is completely assembled and tuned to the customer's frequency at the factory. The antenna is also pressure tested at that time in order to assure an antenna free of leaks.

The mounting brackets are supplied for uniform cross section towers having face dimensions of less than 4 feet or steel poles. Brackets for mounting on tapered towers are available at extra cost. All brackets and hardware are made of stainless steel.

MODEL NUMBERS. The Harris model numbers for the low power FML circularly polarized FM antenna are interpreted as follows:

FML-1E	FML-12C
1 = 1 bay	12 = 12 bay
E = end fed	C = center fed

FML LOW POWER CIRCULARLY POLARIZED FM ANTENNAS

TYPE NO.	POWER GAIN ¹		TYPE FEED	FEMALE 50 OHM INPUT	POWER ² INPUT CAPABILITY	CALCULATED WEIGHT [LBS.]	CALCULATED WIND LOAD [LBS.]
	POWER	dB					
FML-1E	0.4611	-3.3623	END	1- $\frac{5}{8}$ "	9 kW	57	102
FML-2E	0.9971	-0.0128	END	1- $\frac{5}{8}$ "	9 kW	114	212
FML-3E	1.5588	1.9278	END	1- $\frac{5}{8}$ "	9 kW	170	323
FML-4E	2.1322	3.2903	END	1- $\frac{5}{8}$ "	9 kW	227	433
FML-4C	2.1322	3.2903	CENTER	3- $\frac{1}{8}$ "	12 kW	260	509
FML-5E	2.7154	4.3384	END	1- $\frac{5}{8}$ "	9 kW	283	543
FML-5C	2.7154	4.3384	OFF CENTER	3- $\frac{1}{8}$ "	12 kW	317	620
FML-6E	3.3028	5.1888	END	1- $\frac{5}{8}$ "	9 kW	340	654
FML-6C	3.3028	5.1888	CENTER	3- $\frac{1}{8}$ "	12 kW	373	730
FML-7E	3.8935	5.9034	END	1- $\frac{5}{8}$ "	9 kW	396	764
FML-7C	3.8935	5.9034	OFF CENTER	3- $\frac{1}{8}$ "	12 kW	430	840
FML-8E	4.4872	6.5197	END	1- $\frac{5}{8}$ "	9 kW	453	874
FML-8C	4.4872	6.5197	CENTER	3- $\frac{1}{8}$ "	12 kW	486	950
FML-9C	5.0826	7.0608	OFF CENTER	3- $\frac{1}{8}$ "	12 kW	543	1060
FML-10C	5.6800	7.5435	CENTER	3- $\frac{1}{8}$ "	12 kW	599	1171
FML-11C	6.2783	7.9785	OFF CENTER	3- $\frac{1}{8}$ "	12 kW	656	1281
FML-12C	6.8781	8.3747	CENTER	3- $\frac{1}{8}$ "	12 kW	712	1391
FML-13C	7.4785	8.7381	OFF CENTER	3- $\frac{1}{8}$ "	12 kW	769	1501
FML-14C	8.0800	9.0741	CENTER	3- $\frac{1}{8}$ "	12 kW	825	1612

FOOTNOTES. 1. Horizontal and vertical power gain and dB gain are the same. 2. Power input capability up to 2,000 ft. above mean sea level. Derating required above 2,000 ft. 3. Wind load based on 112 mph wind velocity (50/30 psf) and the wind blowing normal to the side of the antenna. Weight and wind load calculations include brackets, interbay line and the transformer section. Calculations based on the frequency of 95 MHz.

SPECIFICATIONS SUBJECT TO CHANGE WITHOUT NOTICE.



HARRIS

FMS DUAL-CYCLOID

CIRCULARLY POLARIZED FM ANTENNA

The Harris Dual-Cycloid Type FMS antenna transmits circular polarization as authorized by FCC rules and regulations. The station's effective radiated power will still be determined by the signal radiated in the horizontal plane. This is determined by the antenna gain (see table) in the horizontal plane multiplied by the power input to the antenna.

Any number of elements from one to sixteen may be utilized, providing maximum flexibility in the selection of power gain for a particular installation. Antennas with null fill, beam tilt, and special horizontal to vertical power splits (other than 50/50) are available. Radomes or deicers are available for climates that experience icing conditions.

The Dual-Cycloid consists of two basic parts: (1) the radiating element and, (2) interconnecting transmission line sections. The radiating elements in an array are all identical electrically and mechanically. Utilizing the effective ring design of the Cycloid as the basic unit, two vertical elements have replaced the fixed end plates; the rear terminal block is now a matching balun mating the antenna impedance to the interconnecting transmission line.

The vertical sections have adjustable caps for a fine adjustment of the horizontal/vertical radiation ratio which is set at the factory. Corona suppression balls are included as a standard item. Designed for rugged trouble-free operation, all antenna elements are fabricated of a durable weather resistant brass alloy with excellent electrical properties.

Antenna elements are normally spaced one wave length apart with interconnecting transmission line sections and feed through a common system input termination of 50 ohms, which is a standard 3 1/8" EIA female flange.

CIRCULARITY. Both the horizontal and vertical radiation pattern of the Dual-Cycloid antenna have been measured within ± 2 dB in free space. When side mounted, the antenna pattern will be somewhat affected by the supporting structure.

Supplied on a standard 3 1/8" EIA line, the antenna is complete with mounting brackets for standard AM and FM towers.

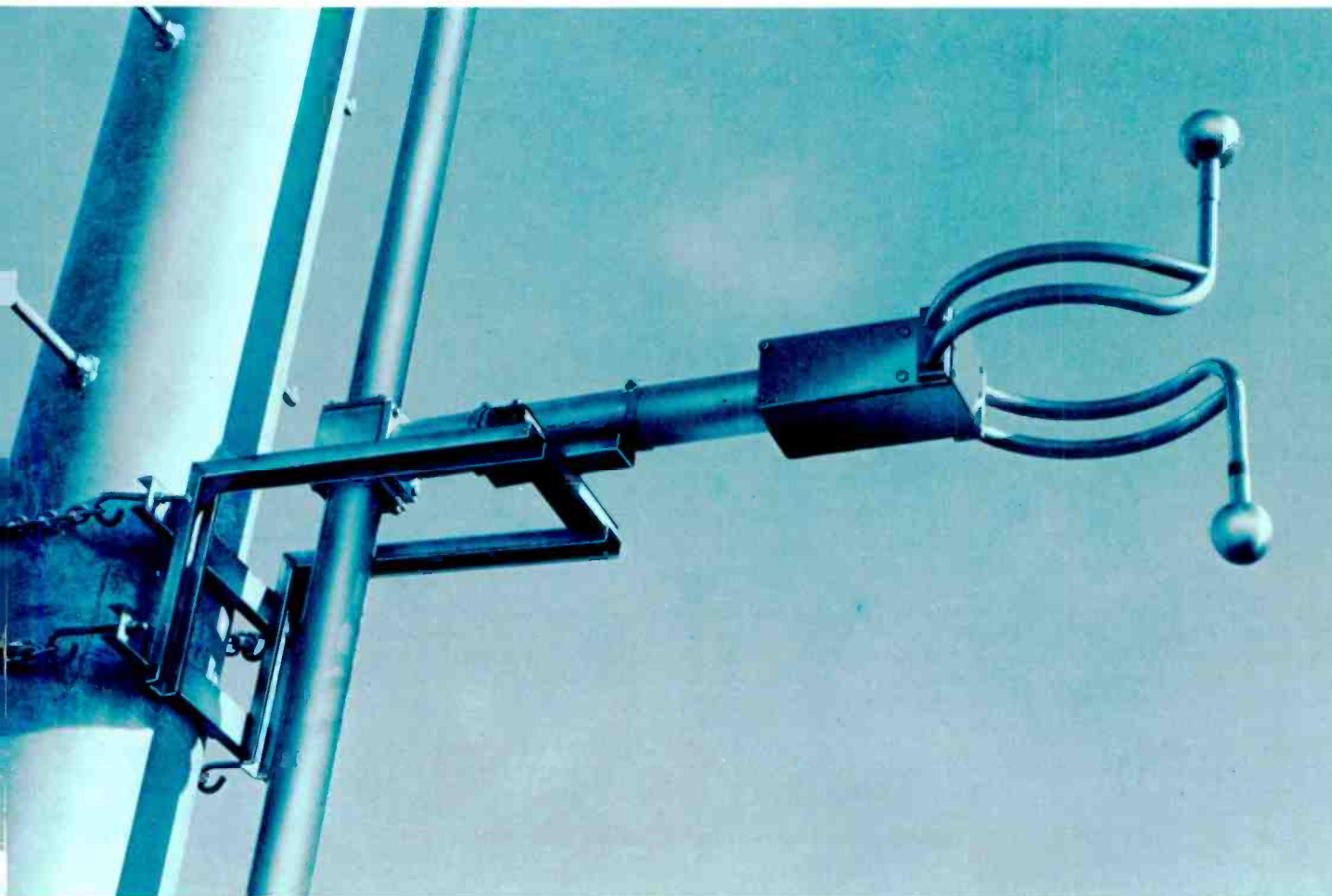

FEED POINT. Antennas of 8 bays or less are usually end fed; a 6 foot matching transformer is connected to the bottom bay. Antennas of 9 bays or more are center fed if an even number of bays, or at a point one-half way below the antenna center if an odd number of bays; a 10 foot matching transformer is connected to an elbow attached to the center feed tee.

MOUNTING. The antenna is mounted on a specially designed stainless steel supporting bracket, fabricated to mate with the tower in a mounting arrangement specified by the purchaser. Antennas are usually mounted on the leg or tower face of a guyed or self supporting tower. A special quotation will be made for brackets on TV towers and non-standard radiators and poles.

Order Type FMS-(X) (X indicates number of bays required)



Radomes available for FMS Antenna

FMS DUAL-CYCLOID SPECIFICATIONS

FREQUENCY RANGE: Factory tuned to one frequency in the 88 to 108 MHz band.

POLARIZATION: Circular, clockwise.

POWER GAIN: See table below. Referred to a half-wave dipole in free space.

AZIMUTHAL PATTERN: Circular ± 2.0 dB in free space for horizontal polarization: same for vertical polarization.

VSWR AT INPUT (Without field trimming): Top mounting, 1.2:1 or better. Side mounting, 1.5:1 or better.

VSWR AT INPUT (With field trimming): Top or side mounting, 1.1:1 or better over ± 100 kHz.

INPUT IMPEDANCE: 50 ohms.

INPUT CONNECTION: 3/8 inch, 50 ohm EIA female flange.

POWER INPUT RATING: Approximately 10 kW per bay (see table).

WINDLOAD: 50 lbs. per square foot for flat surfaces; 33 lbs. per square foot for cylindrical surfaces. Figures available for other wind loading.

DIMENSIONS: (One bay) 30 in. high \times 35 1/2 in. typical.

FEED POINT: One to eight bays, end fed. Nine bays and over, center fed with even number of bays, or at a point 1/2 bay below center with odd number of bays.

FMS DUAL-CYCLOID ANTENNA

TYPE NO.	POWER GAIN [in each polarization]			INPUT POWER RATING KW	APPROX. LENGTH FT. ²	WEIGHT [INCL. BRACKETS] LBS. ³	WIND LOAD LBS. ⁴	WIND LOAD W/RADOMES LBS. ⁴
	POWER	dB	FIELD ¹					
FMS-1	0.4611	-3.3623	0.6790	10	—	80	133	259
FMS-2	0.9971	-0.0128	0.9985	20	10	176	296	547
FMS-3	1.5588	1.9278	1.2485	30	20	262	458	835
FMS-4	2.1332	3.2903	1.4605	40	30	348	620	1123
FMS-5	2.7154	4.3384	1.6478	40	40	434	783	1411
FMS-6	3.3028	5.1888	1.8174	40	50	520	945	1699
FMS-7	3.8935	5.9034	1.9732	40	60	606	1108	1987
FMS-8	4.4872	6.5197	2.1183	40	70	692	1270	2275
FMS-9	5.0826	7.0608	2.2545	40	80	799	1506	2636
FMS-10	5.6800	7.5435	2.3833	40	90	885	1668	2924
FMS-11	6.2783	7.9785	2.5057	40	100	971	1831	3212
FMS-12	6.8781	8.3747	2.6226	40	110	1057	1993	3500
FMS-13	7.4785	8.7381	2.7347	40	120	1143	2156	3788
FMS-14	8.0800	9.0741	2.8425	40	130	1229	2318	4076
FMS-15	8.6818	9.3861	2.9465	40	140	1315	2480	4364
FMS-16	9.2846	9.6776	3.0471	40	150	1401	2643	4652

FOOTNOTES

1. To obtain the effective free space field intensity at one mile in mv/m for one kilowatt antenna input power, multiply field gain by 137.6. 2. When determining coax line length on end feed antenna, add 10' to allow for matching stub. When determining coax line lengths on center feed antenna, termination will be 6' below center due to matching stub. 3. Radome weight is 20 lbs. additional per bay. Heaters are not included in weights given. Heater weight, including junction boxes and interbay cable is 7 lbs. additional per bay. Heater elements replaceable in the field. 4. Based on 50 psf wind pressure on flat surfaces, 33 psf on cylindrical surfaces (112 mph actual wind velocity). Antenna will withstand velocities up to 150 mph.

EQUIPMENT FURNISHED: Antenna elements as ordered; antenna mounting hardware (specify tower manufacturer and type); interconnecting rigid coax transmission line; standard 3/8 inch EIA female flange.

ACCESSORY EQUIPMENT: Deicer system, 300 watts or 500 watts per bay, 115 volts or 230 volts, 50/60 Hz...complete with conduit boxes and RF shielded interbay wiring harness. Radomes also available.

SPECIFICATIONS SUBJECT TO CHANGE WITHOUT NOTICE



HARRIS

DUAL-CYCLOID II DUAL-CYCLOID III

Circularly Polarized FM Antennas



DUAL-CYCLOID II. Harris' Dual-Cycloid II circularly polarized FM antenna provides all of the electrical advantages of the Dual-Cycloid, in a lighter weight, low silhouette design for minimum windloading. The antenna features center feed for medium power handling capabilities—from four to twelve bays handle transmitter powers through 10 kilowatts. Antenna elements are normally spaced one wavelength apart with interconnecting transmission line sections and feed through a common antenna system input termination of 50 ohms, with a standard 3/8 inch EIA female flange.

All antenna elements are fabricated of a durable, weather-resistant brass alloy. Null fill and beam tilt are available. Standard stainless steel brackets for mounting the antenna on the tower leg are included with the antenna. Optional deicers are available, consisting of two 150-watt heating elements per bay, for either 115 volts or 230 volts, as specified. The heater elements are replaceable in the field. Junction boxes and shielded interbay wiring is included. Heater weight including junction boxes and interbay cable, is 6 lbs. additional per bay. Order type FMC-(X) B (X indicates number of bays). Optional radomes are available.

FMC-[X] B SPECIFICATIONS

FREQUENCY RANGE: Factory tuned to one specific frequency in the 88 to 108 MHz band.

POLARIZATION: Circular, clockwise.

FREE SPACE PATTERN: Horizontal component circular ± 2 dB. Vertical component circular ± 2 dB.

VERTICAL TO HORIZONTAL POWER RATIO: Fixed at 50/50.

VSWR: 1.2 to 1 or better ± 200 kHz as tuned at the factory. VSWR when tower mounted 1.5 to 1 or better ± 200 kHz as tuned at the factory. VSWR when tower mounted 1.5 to 1 or better ± 200 kHz. Capable of adjustment 1.1 to 1 ± 100 kHz with field tuning.

POWER GAIN: Horizontal polarization: see table. Vertical polarization: see table. Referred to a half wave dipole in free space.

POWER INPUT RATING: Maximum of 12 kW.

INPUT CONNECTION: 3/8" EIA female flange, 50 ohm.

WINDLOAD: Designed for 50 psf for flat surfaces, 33 psf for cylindrical surfaces.

WEIGHT: Single bay 24 lbs., less brackets. 1 1/2" interbay coaxial line weighs approximately 13 lbs. per section.

DIMENSIONS: Single bay height approximately 30". Length approximately 27".

DUAL-CYCLOID III. Designed for lower power stations, Harris' Dual-Cycloid III circularly polarized FM antenna is an end-fed version of the Dual-Cycloid II—it is lighter in weight, and has less windloading. From one to eight bays handle transmitter powers through 7.5 kilowatts.

The antenna consists of 1 1/2-inch transmission line with individual bays separated by approximately one wavelength at the operating frequency. All antenna elements are fabricated of durable, weather-resistant brass alloy. Null fill and beam tilt are not available on the Dual-Cycloid III.

Deicers are available, they consist of two 150-watt or 300-watt heating elements per bay for either 115 volts or 230 volts, as specified. Junction boxes and shielded interbay wiring harness are included. These elements are factory installed, and are replaceable in the field. Heater weight, including junction boxes and interbay cable, is 6 lbs. Standard stainless steel brackets for mounting the antenna on the tower leg are included with the antenna. Order type FMC-(X) A (X indicates the number of bays required). Optional radomes are available.

FMC-[X] A SPECIFICATIONS

FREQUENCY RANGE: Factory tuned to one specific frequency in the 88 - 108 MHz band.

POLARIZATION: Circular, clockwise.

FREE SPACE PATTERN: Horizontal component circular ± 2 dB. Vertical component circular ± 2 dB.

VERTICAL TO HORIZONTAL RATIO: Fixed at 50/50.

VSWR: 1.2 to 1 or better ± 200 kHz as tuned at the factory. VSWR when tower mounted 1.5 to 1 or better ± 200 kHz. Capable of adjustment to 1.1 to 1 ± 100 kHz with field tuning.

POWER GAIN: Horizontal polarization: see table. Vertical polarization: see table. Referred to a half wave dipole in free space.

POWER INPUT RATING: Maximum of 7.5 kW for three to eight bays. 3 kW for single bay, 6 kW for two bays.

INPUT CONNECTION: A six foot transformer section is attached to the bottom bay of each antenna system which has a 1 1/2" 50 ohm EIA female connector.

WINDLOAD: Designed for 50 psf for flat surfaces, 33 psf for cylindrical surfaces.

WEIGHT: Single bay 24 lbs., less brackets. 1 1/2" interbay coaxial line weighs approximately 13 lbs. per section.

DIMENSIONS: Single bay height approximately 30". Length approximately 27".

DUAL-CYCLOID II

TYPE NO.	POWER GAIN ¹			POWER INPUT [kW]	WT. ² [LBS.]	WIND- ³ LOAD [LBS.]	WIND- ³ W/RAD-OMES [LBS.]
	POWER	dB	FIELD				
FMC-4B	2.1332	3.2903	1.4605	12	197	415	764
FMC-5B	2.7154	4.3384	1.6478	12	238	505	941
FMC-6B	3.3028	5.1888	1.8174	12	279	595	1118
FMC-7B	3.8935	5.9034	1.9732	12	320	685	1296
FMC-8B	4.4872	6.5197	2.1183	12	361	775	1473
FMC-9B	5.0826	7.0608	2.2545	12	402	865	1650
FMC-10B	5.6800	7.5435	2.3833	12	443	955	1828
FMC-11B	6.2783	7.9785	2.5057	12	484	1045	2005
FMC-12B	6.8781	8.3747	2.6226	12	525	1135	2182

DUAL-CYCLOID III

TYPE NO.	POWER GAIN ¹			POWER INPUT [kW]	WT. ² [LBS.]	WIND- ³ LOAD [LBS.]	WIND- ³ W/RAD-OMES [LBS.]
	POWER	dB	FIELD				
FMC-1A	0.4661	-3.3623	0.6790	3	36	74	161
FMC-2A	0.9971	-0.0128	0.9985	6	77	164	338
FMC-3A	1.5588	1.9278	1.2485	7.5	118	254	515
FMC-4A	2.1332	3.2903	1.4605	7.5	159	344	693
FMC-5A	2.7154	4.3384	1.6478	7.5	200	434	870
FMC-6A	3.3028	5.1888	1.8174	7.5	241	524	1047
FMC-7A	3.8935	5.9034	1.9732	7.5	282	614	1224
FMC-8A	4.4872	6.5197	2.1183	7.5	323	704	1402

FOOTNOTES. 1. Power gain in each polarization. To obtain effective free space field intensity at one mile MV/M for one kilowatt antenna power, multiply field gain by 137.6. 2. Weights given include brackets, interbay transmission line and transformer section (center fed tee section and elbow weight also included in Dual-Cycloid III weight). Weight per radome is 18 lbs. for Dual-Cycloid II and 18 lbs. for Dual-Cycloid III (should be multiplied times the number of bays). 3. Windload based on 50 psf on flat surfaces and 33 psf for cylindrical surfaces (actual wind velocity 112 mph). Computed for 100 MHz antenna with mounting brackets but less heater junction boxes and heater cables.

DUAL-CYCLOID II-Length of 4 bay antenna is approximately 30 feet. To determine the length of other antennas, add 10 feet per additional bay. Dual-Cycloid II antennas fed at center if an even number of bays, or at a point 1/2-bay below antenna center if an odd number of bays. A 10-ft. matching transformer is attached to an elbow attached to the center feed tee.

DUAL-CYCLOID III-Length of 2 bay antenna is approximately 10 feet. To determine length of other antennas, add 10 feet per additional bay. When determining coax length, add six feet to antenna length.

EDUCATIONAL FM ANTENNAS

The Harris FM-11 series of FM antennas uses lightweight horizontally polarized ring type radiators having a horizontal plane radiation pattern that is essentially omni-directional. The FM-11 uses a single ring element; the FM-22 uses two ring elements; the FM-33 uses three elements; and, the FM-44 uses four ring elements. Antennas having more than one ring element use a vertical spacing of one wavelength between elements.

The antennas are designed for mounting on a pipe or pole having an outside diameter of 2 to 2½ inches. Two "U" bolts are provided on each antenna element for mounting. The mounting pole is not supplied, but can be provided at additional cost, as can the proper coaxial cable.

FM-11 SERIES SPECIFICATIONS

FREQUENCY RANGE: Factory tuned to one specific frequency in the 88-108 MHz band.

POLARIZATION: Horizontal.

TYPICAL PATTERN WHEN MOUNTED ON SMALL STEEL POLE: Horizontal plane pattern circularity of approximately ± 3 dB.

TYPICAL VSWR: 1.5 to 1, or less, ± 1.2 MHz.

INPUT CONNECTOR: Type UHF female which mates with the type UHF male (PL-259 or 83-1SP).

WINDLOAD CALCULATION: Based on 50 lbs./sq. ft. for flat surfaces, 33 lbs./sq. ft. for cylindrical surfaces (wind velocity of 112 miles per hour).

DIMENSIONS: Single bay height approximately 9". Length approximately 23". Two bay antenna 11 ft. high; 3 bay is 22 ft.; 4 bay is 33 ft.

ORDERING INFORMATION

FM-11A Single ring antenna710-0102-000
 FM-22A 2-ring antenna710-0103-000
 FM-33A 3-ring antenna710-0201-000
 FM-44A 4-ring antenna710-0202-000

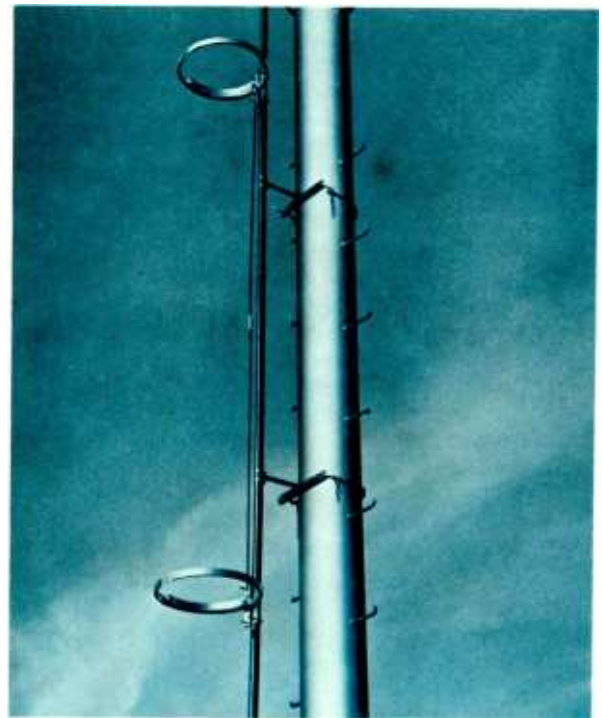

FM11 SERIES

TYPE NO.	POWER GAIN			POWER RATING [WATTS]	WT. [LBS.]	WIND-LOAD [LBS.]
	POWER	dB	FIELD			
FM-11	0.80	-0.969	0.894	500	7.5	52.5
FM-22	1.80	2.55	1.342	800	16.5	117
FM-33	2.75	4.39	1.658	800	27.5	196
FM-44	3.72	5.70	1.929	800	36	257

SPECIFICATIONS SUBJECT TO CHANGE WITHOUT NOTICE.



HARRIS

DIRECTIONAL DUAL POLARIZED FM ANTENNA

- No de-icing required under normal environmental conditions
- Internal feed point to radiating element
- Pattern tested
- Field trimming normally not required
- High power handling capability
- Rugged brass construction
- Stainless steel support brackets
- Wide bandwidth characteristics

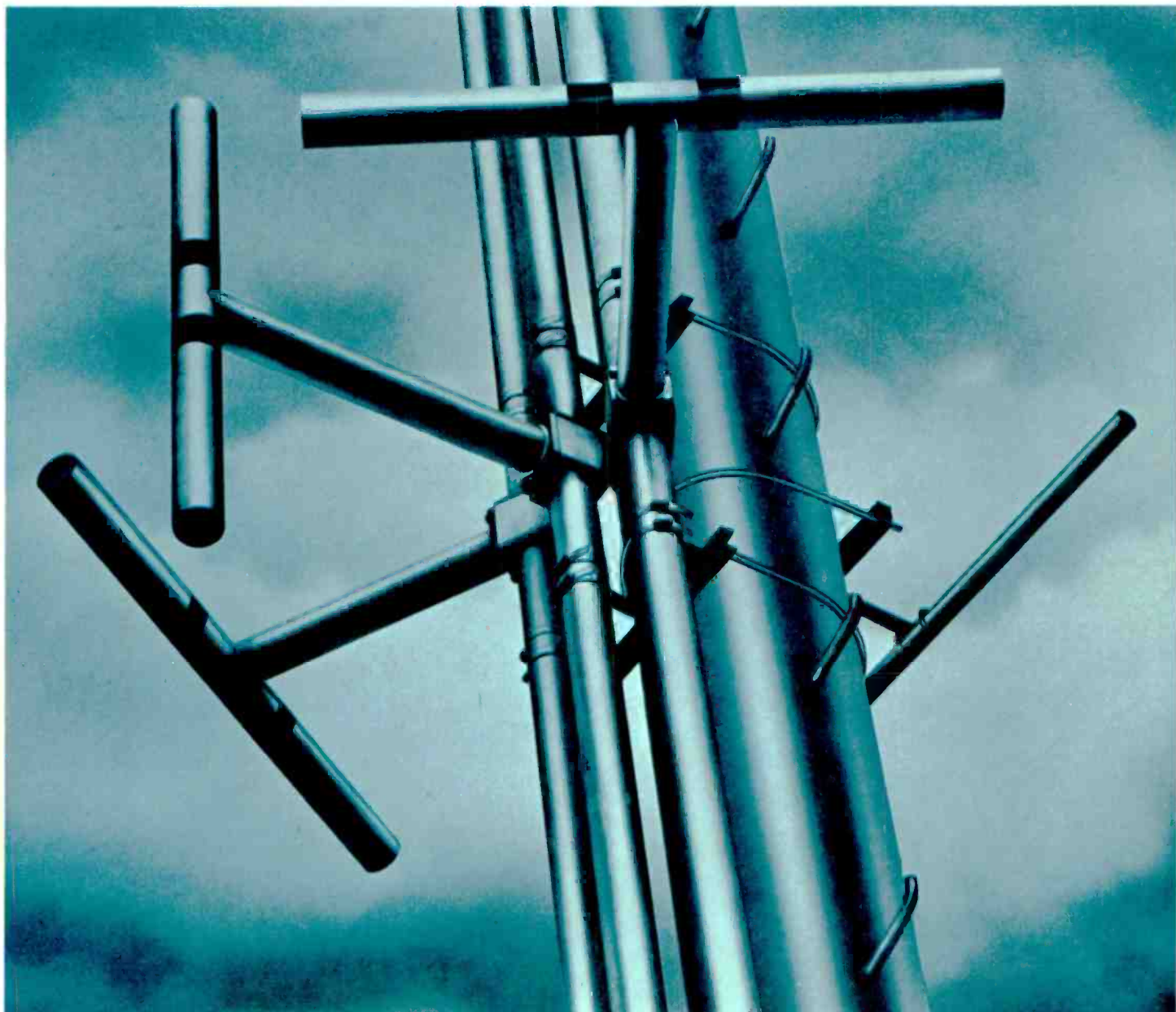

Harris' FMD-(X) is a directional dual polarized FM antenna designed for pole mounting. It is available with up to eight bays and with either 1- 5/8 inch or 3- 1/2 inch EIA 50 ohm female input. The "X" in the type number indicates the number of bays. The suffix "A" following the complete type number signifies 1- 5/8" input and the suffix "B" indicates 3- 1/2" input. (Example—FMD-4A is a 4-bay antenna with 1- 5/8" input).

UP TO 40 KW INPUT POWER. The maximum power input capability for the "A" series is 12 kilowatts. The maximum power input capability for the "B" series is 20 kilowatts for a single bay, and 40 kilowatts for two (2) through eight (8) bays.

The interbay lines use 3- 1/8 inch rigid, with three such lines used between bays, two for the horizontal element feeds and one for the vertical element feeds. A combiner, for combining the three transmission line feeds, is used below the bottom bay. A six foot transformer section is used immediately below this combiner.

BROADBAND DIPOLE ELEMENTS. The antenna uses broadband 3- 1/8" diameter dipole elements, and these will not require deicing under normal environmental conditions. Each bay level normally uses two driven horizontal elements, one horizontal parasitic reflector and one driven vertical element. In some cases, vertical parasitic elements may be used on each bay for the purpose of further shaping the vertical polarization component.

Heaters are not normally required for antenna deicing purposes due to the excellent bandwidth characteristics exhibited by the antenna. Typically, as measured between 1.5:1 VSWR points, the bandwidth is in the region of 5 to 7 MHz. As a result, the antenna could probably experience icing of up to 3/4 inch thickness without the VSWR going above 1.5:1.

ANTENNA SYSTEM PRESSURIZATION. The antenna system is designed to be pressurized, using dry air or dry nitrogen, and the system should be purged and then pressurized to a positive pressure of approximately 2 to 5 pounds per square inch (0.14 to 0.35 kilograms per square centimeter) immediately following installation.

CUSTOM MOUNTING POLE. The FMD antenna is supplied with a custom matching pole, thereby permitting the support pole to be drop shipped directly to the customer. The directional antenna may be purchased without the pole only on a special quotation basis, in which case there will be an added engineering charge made, and the cost of the Harris pole deducted from this total price. The pole is a hot dip galvanized pedestal mount, with removable step bolts. For poles 30 feet or more in length the minimum wall thickness is 0.500 inch. A plate is provided on the top of the pole as a support for a beacon. Should a buried pole support be desired, specific requirements will be needed for a special price quotation.

ANTENNAS PATTERNED AT FACTORY. Each Harris FMD directional antenna is patterned on a test range, not at the customer's site. A single bay of the antenna (in accordance with FCC pattern test requirements) is mounted on a pole identical (or electrically equivalent) to that on which the antenna is to be finally installed. If the customer supplies his own pole, then complete data on the pole must be submitted for final pattern testing.

The antenna is patterned with the test pole erected vertically on a turntable on the antenna range, and measurements made in the xy, or horizontal plane, for both the horizontal and vertical polarization components. Normally, the antenna bay being patterned is operated in the transmitting mode. A special dipole

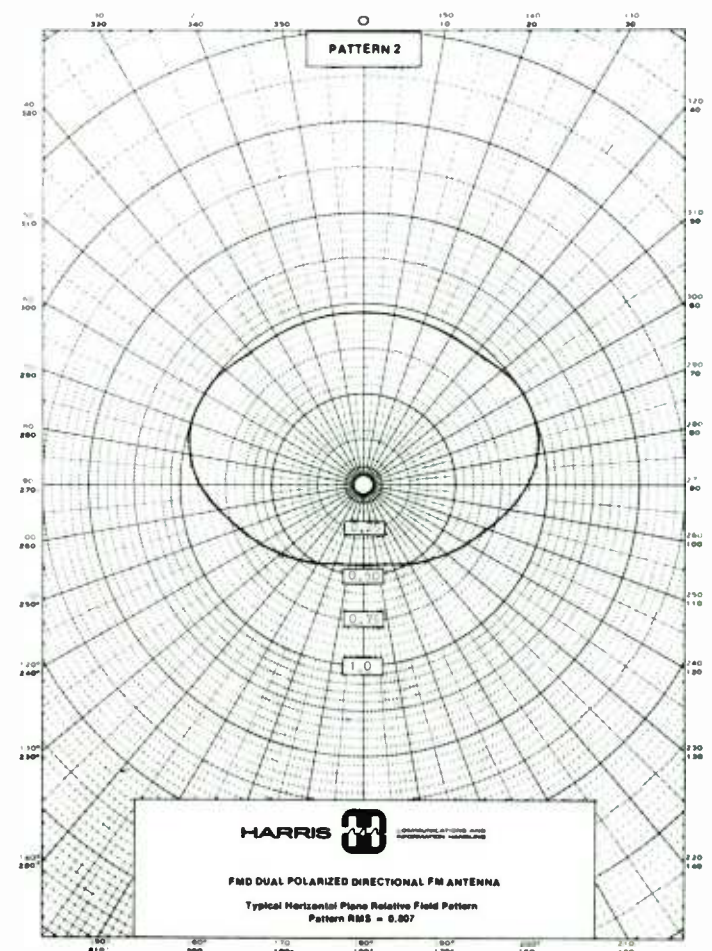
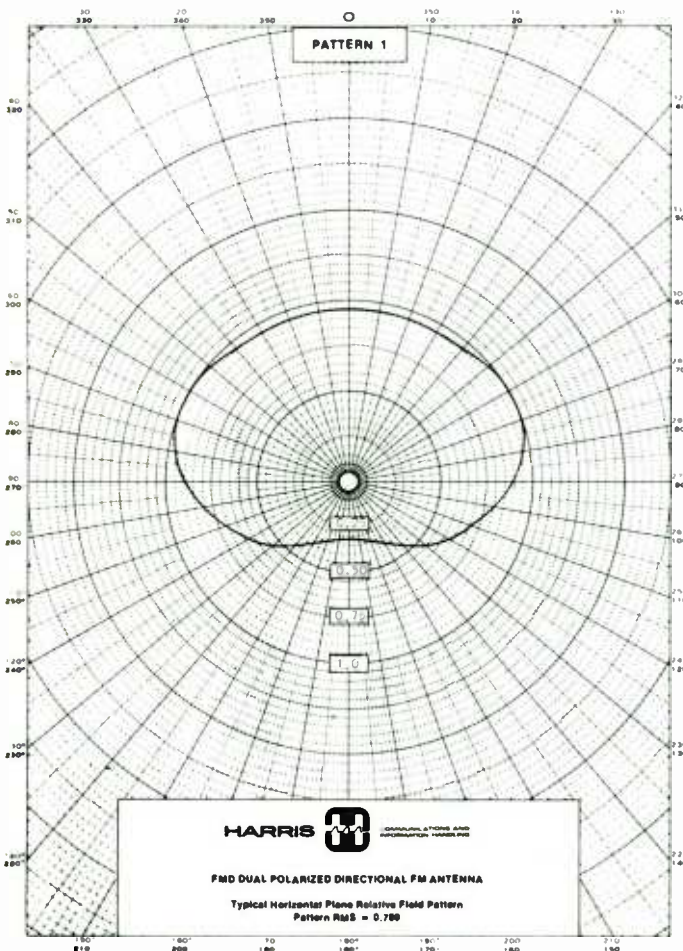

receiving antenna, located a sufficient distance away, is used with its output feeding an accurate field intensity meter, and the pattern of the antenna plotted as the test pole is rotated. Patterns for each of the two polarization components are plotted separately. Adjustments are made to the antenna bay in order to achieve a suitable antenna radiation pattern.

The complete antenna is assembled on a steel pole and carefully tuned at the factory. As a result, field trimming should normally not be required.

The final pattern achieved may be expected to differ slightly from the initial pattern proposed, so it may be necessary to file an application to modify the construction permit to comply with the exact measured pattern, which the customer will receive upon the completion of the antenna pattern tests.

Following the completion of the final patterning of the antenna, Harris will provide the station, and/or its consultant, with the final measured antenna radiation pattern, calculated gain data, and the details of the antenna pattern measurement procedure. This final data is then submitted by the station to the FCC or other broadcasting authority.

ORDERING INFORMATION. Orders for the Harris Dual Polarized Directional FM Antenna should specify the desired true azimuth orientation, maximum ERP permitted, radiated power limitations and their true orientation, transmission line efficiency (or specify the type of transmission line and its length), and the transmitter power output capability. Such antenna pattern requirements are normally specified by the stations's consultant. Ideally, a copy of the FCC construction permit should be supplied so that the manufacturer can assure full compliance with the requirements of such authorization relative to the antenna.

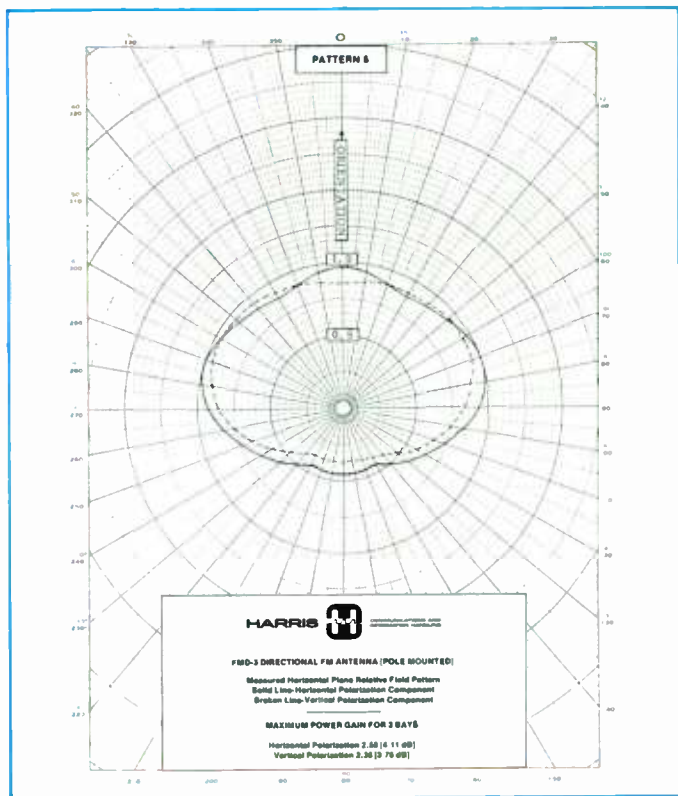

The pattern shown above is that of a three-bay Harris FMD-3 Dual Polarized Directional FM Antenna designed specifically for the 107.7 MHz frequency.

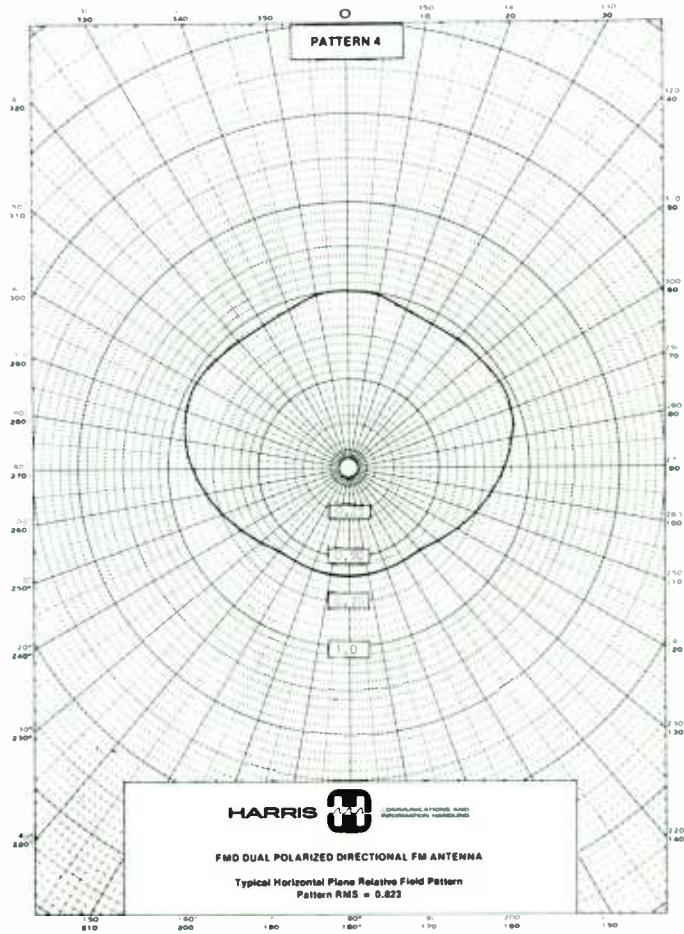
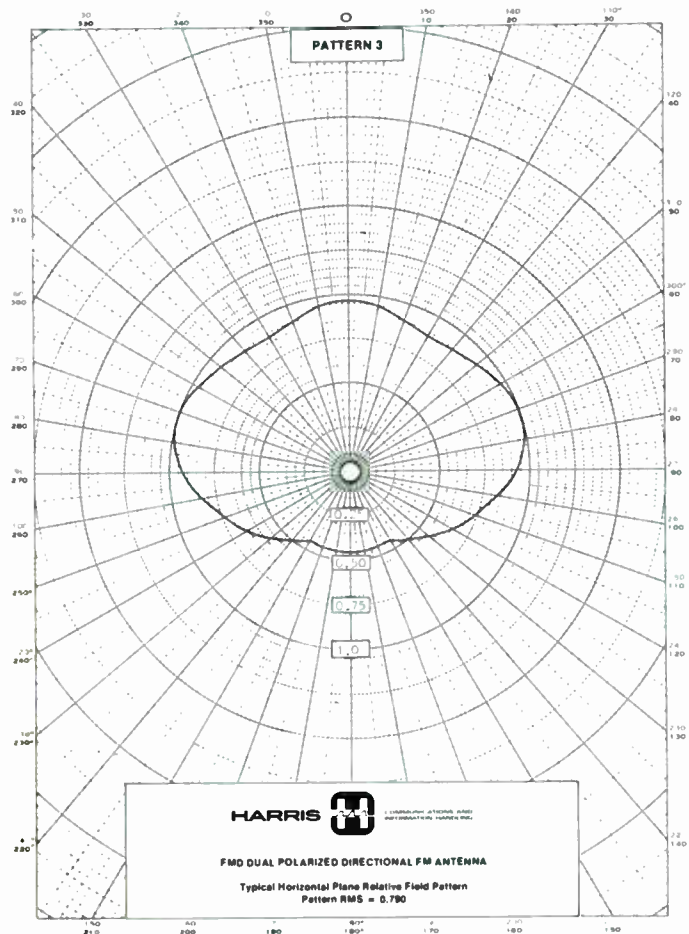

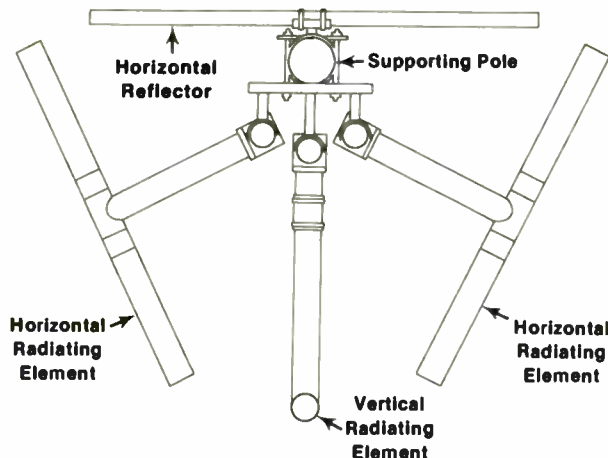

**HARRIS FMD DUAL POLARIZED
DIRECTIONAL FM ANTENNA-TOP VIEW**

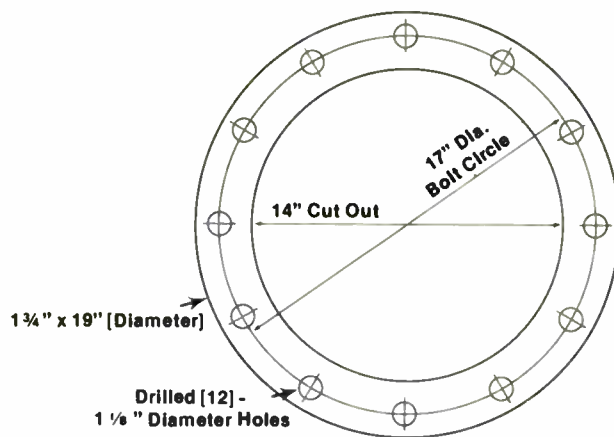

**POLE MOUNTING FLANGE
For Harris Dual Polarized
Directional FM Antenna
[Does not apply to FMD-1A or 1B]**

ELECTRICAL AND MECHANICAL DATA

HARRIS TYPE NO.	INPUT POWER RATING KW	FEMALE INPUT FLANGE	POLE LENGTH FT	WEIGHT POLE AND ANTENNA LBS	TOTAL WIND LOAD [BASED ON 50/33 PSF] LBS	OVER-TURNING MOMENT FT LBS	HEIGHT ELEC-TRICAL CENTER ABOVE TOWER TOP FT	BOLT CIRCLE DIAMETER INCHES
FMD-1A	12	1 5/8 "	20	606	796	9595	16	9
FMD-1B	20	3 1/8 "	20	626	832	10000	16	9
FMD-2A	12	1 5/8 "	30	2240	1821	30024	21	17
FMD-2B	40	3 1/8 "	30	2260	1856	30593	21	17
FMD-3A	12	1 5/8 "	40	2994	2557	54917	26	17
FMD-3B	40	3 1/8 "	40	3014	2593	55682	26	17
FMD-4A	12	1 5/8 "	50	4245	3490	89308	31	17
FMD-4B	40	3 1/8 "	50	4265	3526	90254	31	17
FMD-5A	12	1 5/8 "	62	5901	4680	153210	38	17
FMD-5B	40	3 1/8 "	62	5921	4716	154407	38	17
FMD-6A	12	1 5/8 "	72	7956	5523	208204	43	17
FMD-6B	40	3 1/8 "	72	7976	5559	209581	43	17
FMD-7A	12	1 5/8 "	82	9250	6350	271315	48	17
FMD-7B	40	3 1/8 "	82	9270	6386	272872	48	17
FMD-8A	12	1 5/8 "	92	11305	7192	343159	53	17
FMD-8B	40	3 1/8 "	92	11325	7227	344847	53	17

MAXIMUM POWER GAIN FOR TYPICAL PATTERNS 1-4 ON PREVIOUS PAGES

HARRIS TYPE NO.	PATTERN 1		PATTERN 2		PATTERN 3		PATTERN 4	
	HORIZ.	VERT.	HORIZ.	VERT.	HORIZ.	VERT.	HORIZ.	VERT.
FMD-(1A or 1B)	0.81	0.72	0.79	0.70	0.76	0.70	0.72	0.69
FMD-(2A or 2B)	1.74	1.53	1.70	1.49	1.63	1.50	1.54	1.47
FMD-(3A or 3B)	2.71	2.39	2.64	2.33	2.54	2.34	2.39	2.29
FMD-(4A or 4B)	3.70	3.26	3.61	3.18	3.47	3.19	3.26	3.13
FMD-(5A or 5B)	4.71	4.14	4.58	4.03	4.40	4.05	4.14	3.98
FMD-(6A or 6B)	5.71	5.03	5.56	4.90	5.35	4.92	5.03	4.83
FMD-(7A or 7B)	6.73	5.92	6.55	5.77	6.29	5.79	5.92	5.68
FMD-(8A or 8B)	7.75	6.82	7.55	6.64	7.25	6.67	6.82	6.54

NOTE: The above power gain figures are approximate only, but are useful as a guide in determining the number of bays required. The gain figures will vary with the pattern shape, and the exact gain figures are determined when the final antenna pattern is achieved.

The power gain for the vertical polarization component is less than the horizontal polarization component since it will differ a bit in shape, and in addition, the vertically polarized component can not exceed the horizontally polarized component at any azimuth.



HARRIS

TV-50H

50-Kilowatt VHF High Band
Color Television Transmitter

TVD-100H

100-Kilowatt Dual VHF High Band
Color Television Transmitter

- Compact TV-50H design permits 100-kW dual configuration for CP use in approximately same floor space as existing 50-kW transmitters
- Solid-State IPA's
- Only 3 tubes (TV-50H)/6 tubes (TVD-100H)
- Transversal SideBand filter—no group delay, no tuning adjustments required
- IF Modulation of the visual and aural carriers
- Automatic power control standard
- Excellent cooling system
- Latest design for unattended operation
- Modular, pre-wired cabinets for easiest installation

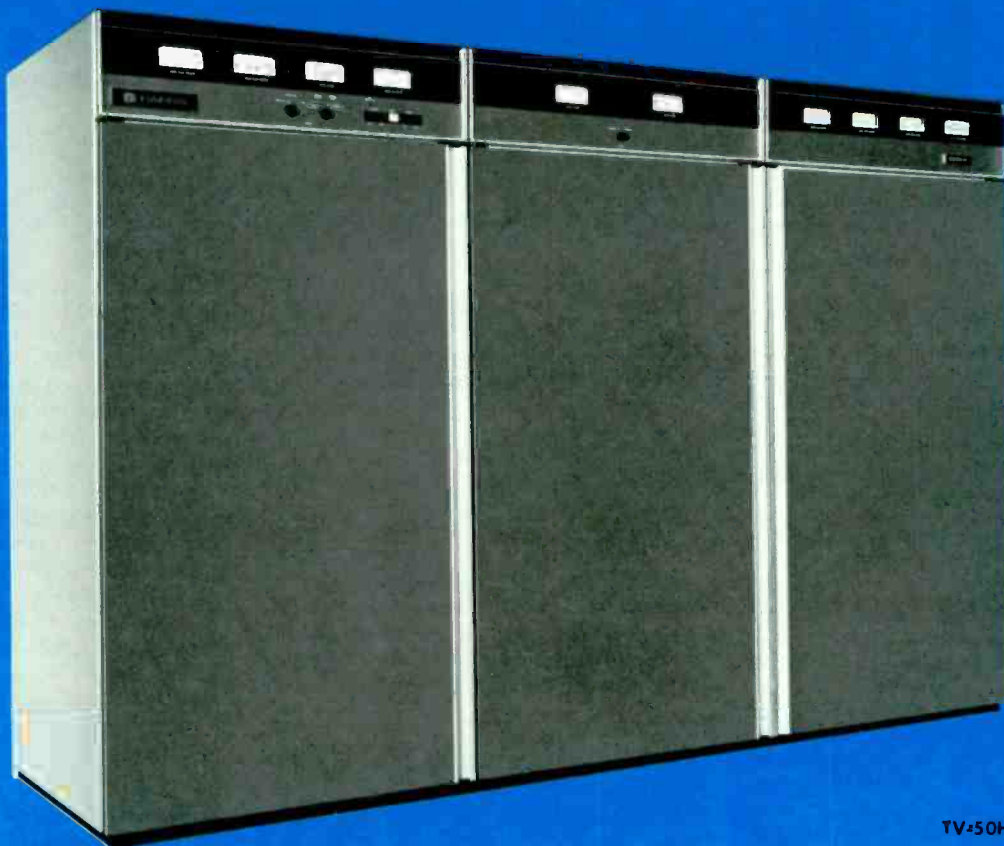

TV-50H

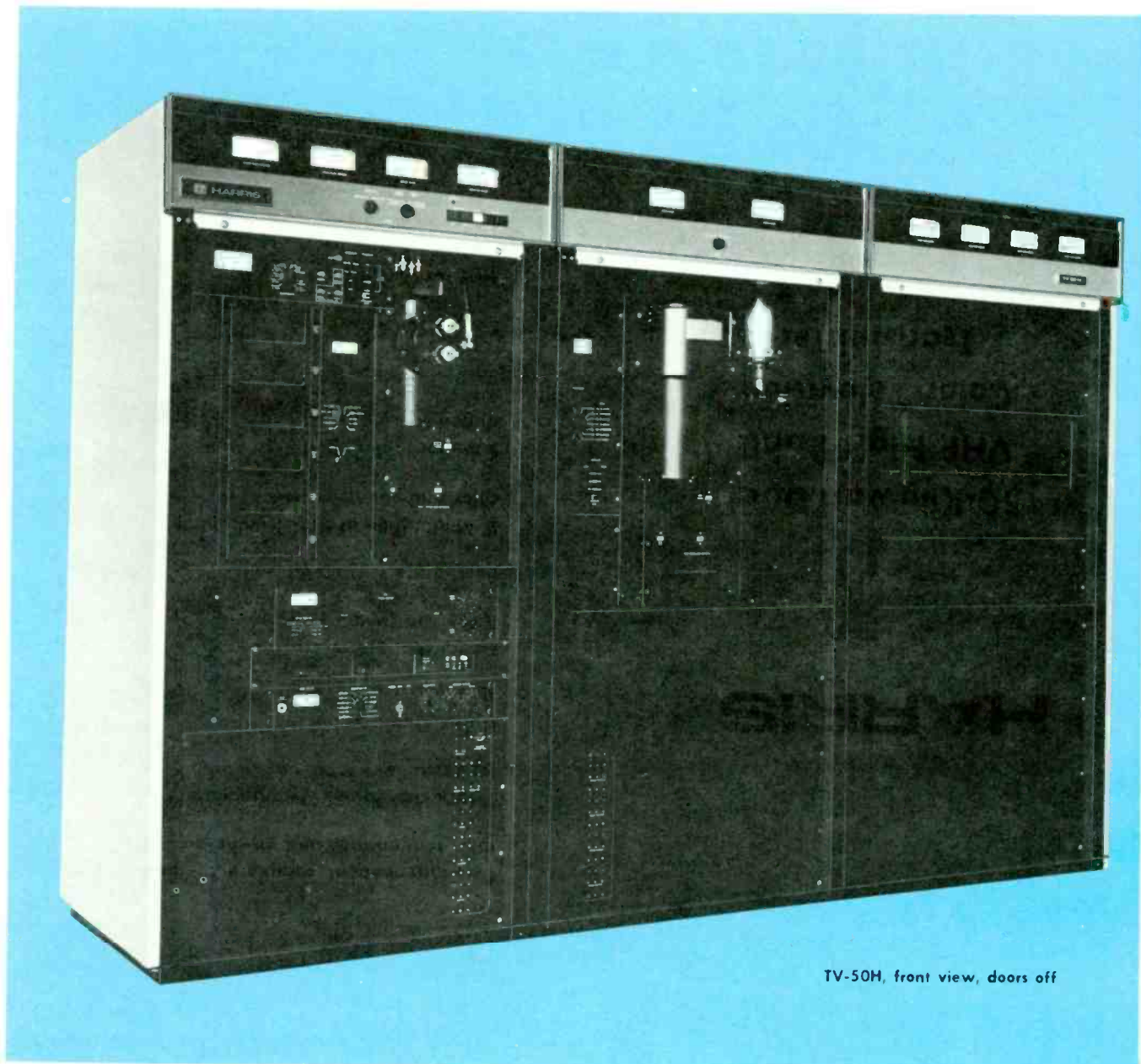

TV-50H, front view, doors off

TV-50H... SOLID-STATE IPA/ THREE-TUBE DESIGN

The Harris TV-50H features a solid-state IPA and a three-tube design to greatly enhance reliability, reduce tuning requirements and allow an unusually compact cabinet configuration.

This advanced high band VHF-TV transmitter requires only one aural and two visual tubes to provide a 50-kilowatt visual and a 5-kilowatt aural output. A circulator between the visual stages minimizes retuning requirements after a tube change.

The solid-state IPA contains broadband amplifiers so that no tuning is required—and it is fully protected against damage caused by overloads or load variations. Gradual (1 to 2 seconds) RF turn-on permits DC voltage stabilization before RF drive application to power

amplifiers, for added transmitter protection. The IPA is fully metered for monitoring and maintenance, while excellent cooling helps maintain long transistor life.

DUAL CONFIGURATION FOR CP APPLICATIONS

The compact design of the TV-50H makes it ideal for 100-kilowatt dual configurations for use with circularly polarized TV antennas. A 100-kilowatt configuration, employing two TV-50H's and a center control cabinet, would require only about the same floor space as one existing 50-kilowatt transmitter!

SUPERB PERFORMANCE

In addition to a solid-state IPA, the TV-50H incorporates such state-of-the-art

features as Harris' Transversal SideBand (TSB) filter; IF (intermediate frequency) Modulation; true linear operation of power amplifiers; and solid-state visual and aural exciter/modulators, to provide the finest color performance and sound fidelity available today. As no envelope delay correction or adjustments are required for the sideband filter, stability, reliability and color quality are greatly enhanced. Frequency adjustment, power output control and amplifier tuning are straightforward and uncomplicated, while design simplicity and conservatively rated components assure long-term "hands-off" operation and minimum maintenance.

The TV-50H consists of a 1.7-kilowatt exciter/driver, an aural power amplifier, a visual power amplifier, and an external HV power supply. The transmitter employs a single-ended visual PA

(8984 tetrode) for low power consumption, and DC filaments in the visual and aural stages for improved signal-to-noise ratios.

TRANSVERSAL SIDEBAND (TSB) FILTER

The Harris solid-state sideband filter is an advanced surface acoustic wave design, and shapes visual sidebands at the IF frequency, rather than "on frequency" at the full output power of the transmitter. Unlike previous VSB filters, which require from 600 to 1000 nsec of group delay correction and many adjustments, the TSB filter has an inherent linear phase characteristic and requires no group delay correction. Other VSB filters need 6 to 12 tuning controls, while the Harris TSB filter needs no tuning controls as it requires no tuning adjustments—ever!

Additionally, the TSB filter has steeper skirts and higher attenuation outside the channel passband for improved VSB wave shaping.

Only 1½ square inches in size, the TSB filter is mounted on a PC board in the visual exciter.

SOLID-STATE VISUAL AND AURAL EXCITER/MODULATORS

The Harris solid-state MCP-1V visual exciter/modulator is an independent, self-contained unit which provides a fully processed on-channel picture signal. Power output can be varied up to one watt with a single front panel control, or from a remote location, without retuning of any kind.

The exciter is mounted in a pull-out drawer and may be operated outside the main transmitter for test purposes. A switch and meter mounted on the front panel permit monitoring exciter parameters. Power and video gain controls are motor driven with manual override provision.

The MCP-1V provides great reliability and stability, excellent frequency response, and truest color quality. It is also designed for minimum maintenance and set-up time, and for remote control and unattended operation. This is all made possible through the use of the latest design techniques, including Harris' solid-state TSB filter.

The Harris aural exciter/modulator is a solid-state self-contained unit which furnishes a fully processed aural signal at a level up to 10 watts. Power output can be set with a single knob on the front panel, or by remote control, with no need for retuning. The aural exciter/modulator is mounted in a pull-out drawer, and may be operated with the



The MCP-1V visual exciter/modulator is a solid-state, independent, self-contained "on-channel" signal source. Harris' TSB filter (right) is mounted on a PC board in the visual exciter, and measures only 1½ inches square.



drawer extended for test purposes.

IF MODULATION

One of the important features of the TV-50H is its true low-level IF Modulation, which offers a top quality picture, and excels in electrical performance, reliability and simplicity of operation.

In the TV-50H the visual and aural exciters generate fully modulated low-level IF signals. The output of a common crystal controlled reference oscillator is used to raise the individual IF signal to the desired "on channel" output frequency.

As it occurs at much lower power levels than other designs, intermediate frequency modulation needs fewer circuits to produce a fully processed, quality picture signal. Less than one volt of video signal is needed to modulate the RF carrier.

The Harris ring modulator design permits modulation percentages to approximately 2% without compromising transmitter performance—and eliminates most pre-distortion circuitry. This results in exceptional color performance and nearly perfect signal linearity. Even such colors as highly saturated yellow and cyan are faithfully reproduced with IF Modulation.

Due to the low-level techniques, which include the use of devices such as an extremely linear broadband diode ring modulator, low-level sideband filtering and very linear broadband amplifiers, the broadcast signal is a faithful reproduction of the signal applied to the transmitter input. IF Modulation results in low incidental phase noise, and the elimination of many transmission problems at their source. This means that no half-way measures—such

as numerous correction, compensation and feedback circuits—are required to eliminate the effects of these problems later.

SOLID-STATE CONTROL CIRCUITS

Solid-state memory, timing and logic circuits—employing CMOS IC's for design simplicity and enhanced reliability—offer complete and foolproof control of all transmitter functions. Built-in memory circuitry enables the entire transmitter to return to the air automatically in the stage it was operating prior to a partial or full power failure. The memory is continuous, and is maintained without an emergency power source during power failures.

The control logic and protective circuitry, in addition to commanding normal AC control functions, is also used to visually indicate, through indicator lights, the operating status of the transmitter system. These indicator lights allow isolation of circuit faults, and are easily removed.

REMOTE CONTROL, UNATTENDED AND AUTOMATIC OPERATION

All control, metering and monitoring circuits have been designed specifically for remote control and unattended operation. The power controls are motor driven and the necessary remote control sampling points are built-in on accessible terminal boards.

Today, Harris TV transmitters are being operated successfully worldwide in an unattended mode, with and without remote control access. In addition, Harris' transmitter design is consistent with anticipated automatic transmitter needs in the future.

AUTOMATIC POWER CONTROL

Automatic gain control of all RF amplifier stages, in conjunction with the exciter's automatic power control, insures constant power output, even with variations in line voltages. This feature is standard in the TV-50H.

STABILITY

One factor assuring RF stability is the use of a solid-state IPA and conservatively rated Type 8988 and 8984 ceramic tetrodes operating as VHF linear amplifiers. These amplifier stages operate in a common grid and screen configuration and tube neutralization is not required.

EXCELLENT COOLING SYSTEM

The cooling system of the TV-50H is quiet and efficient, and employs direct drive blowers, with motors fully protected by automatic reset devices. Tube manufacturers' recommendations are met or exceeded at altitudes up to 7,500 feet, enhancing tube life without power derating.

POWER SUPPLIES

The HV power supply is a multi-phase full wave rectifying system exhibiting very low ripple content prior to output filtering. It is designed for excellent regulation and low video impedance for optimum picture performance. This power supply, including transformer and solid-state rectifiers, is housed in a single assembly, mounted externally from the transmitter. Routine maintenance access is provided by a removable panel.

Vacuum tube filaments are fed with DC to maximize the output signal-to-noise ratio. Grid and screen supplies use solid-state regulators.

The 1700-watt driver cabinet has an independent solid-state HV power supply, and the visual and aural exciters have their own independent, solid-state regulated power supplies.

EASE OF MAINTENANCE AND INSTALLATION

Total transmitter component accessibility is provided, front and back. Visual and aural exciters slide out and can operate independently from the transmitter outside the exciter/driver cabinet. Various exciter circuits, such as oscillators, modulators and processing circuitry, are of modular construction and can be removed for maintenance or replacement.

Easy to read, and mounted at eye-level, 4-inch meters are provided to monitor required transmitter functions. Meter panels are double-hinged for con-

venient access during maintenance. A complete system of overload indicators is also provided in each cabinet for monitoring transmitter operation. In the event of a transmitter malfunction, an examination of the indicators will locate the problem area.

The transmitter has been built in a modular fashion so that cabinets may be separated into convenient, easy-to-handle sub-assemblies to facilitate installation. Additionally, the compact design of the TV-50H minimizes space requirements in the transmitter building.

TVD-100H - 100-KILOWATT DUAL HIGH BAND COLOR TV TRANSMITTER

Designed for use with circularly polarized television antennas, the TVD-100H furnishes a 100-kilowatt visual power output, yet occupies approximately the same floor space as existing 50-kilowatt TV transmitters! This dual transmitter consists of two completely independent 50-kilowatt transmitters (TV-50H's) operating in parallel, combined through the Harris unique-design Dualtran RF switching system.

With the TVD-100H you get two aural exciter/modulators, two visual exciter/modulators, two TSB filters, two solid-state visual and aural IPA's, two visual and aural PA's and two HV power supplies—in short, total redundancy. Complete reliability.

The Dualtran switching system is factory assembled in one cabinet, and can interface with either a hybrid or a notch diplexer.

AUTOMATIC SWITCHING. In the event of a malfunction of one-half of the parallel combination, the Harris TVD-100H offers automatic and instantaneous reduction to one-fourth authorized power. This function will occur without interruption of the carrier. With the touch of a button, half-power operation is achieved in less than three seconds.

Visual and aural exciters are connected in a hot standby condition, and will automatically switch in less than 10 milliseconds in case of failure in either unit. In all modes, aural follows visual for simplified logic control and reliable operation.

OPERATING VERSATILITY. Four modes of operation may be obtained electrically by means of control pushbuttons on the output switcher; by control buttons on the transmitter control panel; or by remote control. These are:

- Transmitters A and B combined and diplexed to the antenna (normal operating mode).
- Transmitter A diplexed to the antenna and transmitter B to the station loads (alternate/main or

emergency operation).

- Transmitter B diplexed to the antenna and transmitter A to the station loads (alternate/main or emergency operation).
- Transmitters A and B combined to the station loads (test mode).

The switching operation from one mode to any other mode requires less than three seconds.

When using a notch diplexer, three other operating modes may be selected manually by changing links on the Dualtran output switching cabinet; transmitters A and B combined and diplexed to the station loads; transmitter A diplexed to the station loads; and transmitter B diplexed into station loads.

CONTROL CABINET. The RF Phasing and Control Panel and the Automatic Exciter/Modulator Switcher are standard equipment with the TVD-100H, and are located in a control cabinet that is typically placed between the two independent 50-kilowatt transmitters. The cabinet is the same height as the transmitters, and the same color, to provide a pleasing installation. All adjustments for dual operation may be made at this cabinet.

The Harris exciter/modulators, with IF Modulation, allow phasing of transmitters for dual operation to be accomplished simply and reliably at low power levels from the RF Phasing and Control Panel. In addition to phasing control, the panel has provisions for monitoring total combined aural power and total combined visual power in forward and reflected modes.

The Automatic Exciter/Modulator Switcher is also a standard part of the control cabinet, and allows for either manual or automatic selection of exciters.

SPECIFICATIONS. Visual and aural performance specifications of the TVD-100H are the same as those of the TV-50H (with the exception of visual power output and aural power output).

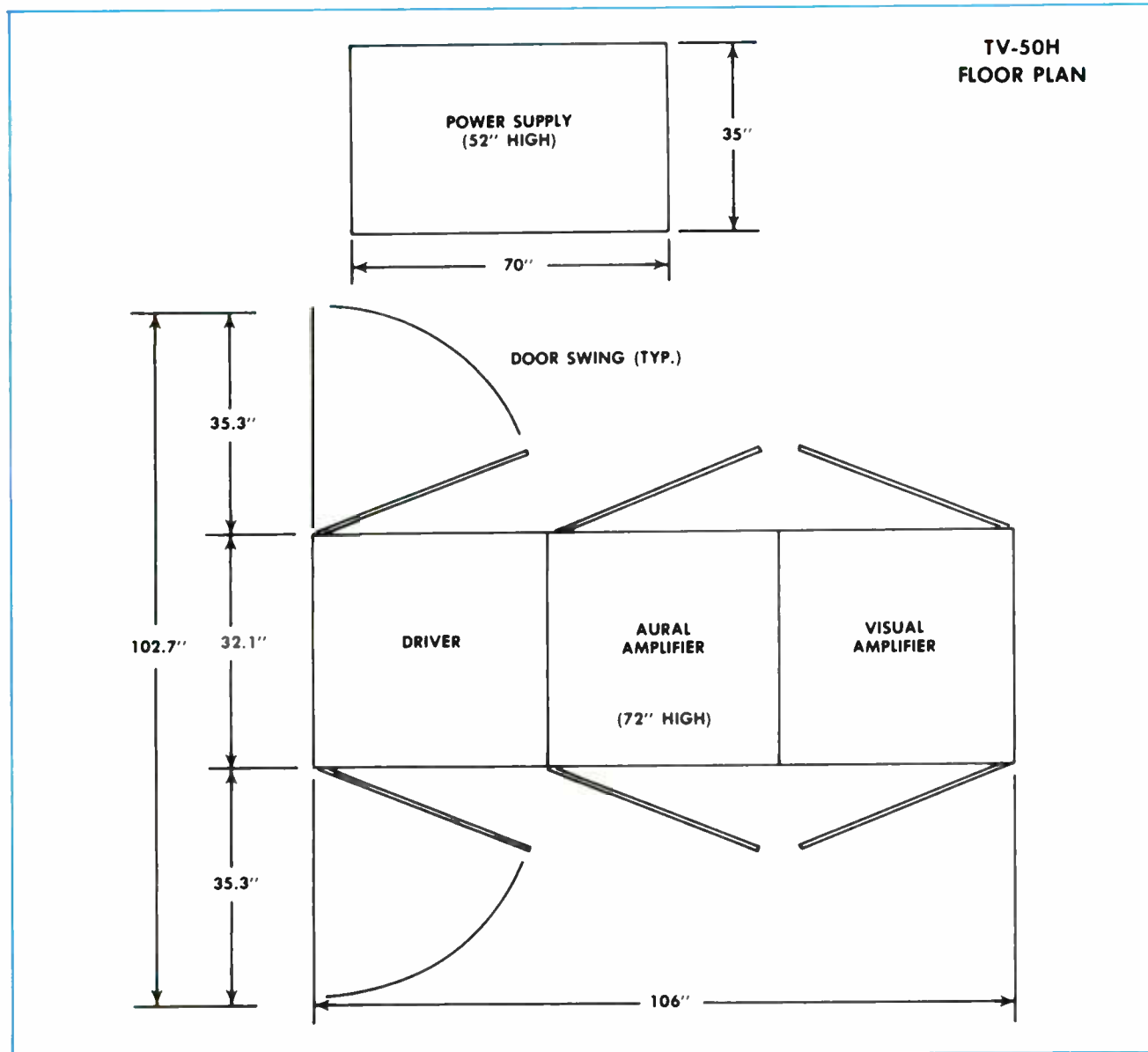
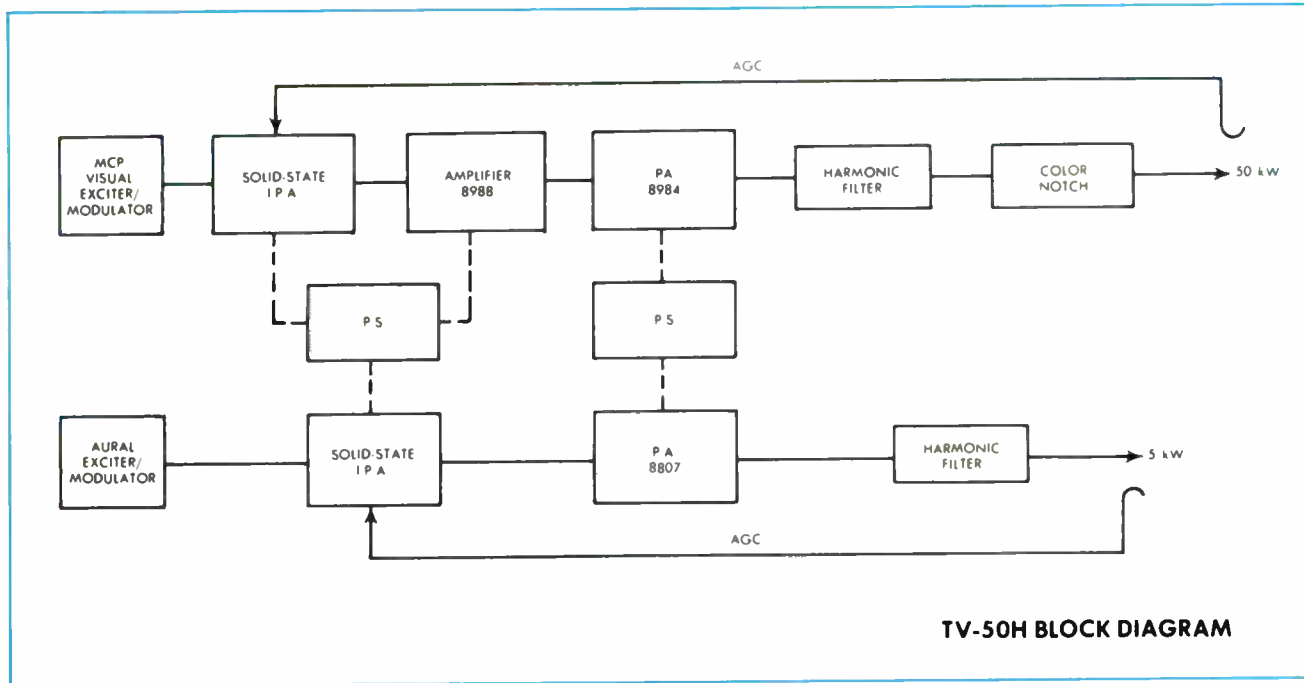

TV-50H SPECIFICATIONS

(NOTE: TVD-100H visual and aural performance specifications same as below except for visual power output and aural power output.)

VISUAL PERFORMANCE

POWER OUTPUT:
 OUTPUT IMPEDANCE:
 FREQUENCY RANGE:
 CARRIER STABILITY:¹
 REG. OF RF OUTPUT POWER (Black to white pic.):
 VARIATION OF OUTPUT (over one frame):
 VISUAL SIDEBAND RESPONSE:

FREQUENCY RESPONSE VS. BRIGHTNESS:²
 VISUAL MODULATION CAPABILITY:
 DIFFERENTIAL GAIN:³
 LINEARITY (LOW FREQUENCY):
 DIFFERENTIAL PHASE:⁴
 INCIDENTAL PHASE MODULATION:
 SIGNAL-TO-NOISE RATIO:
 K FACTORS:
 EQUIVALENT ENVELOPE DELAY:

VIDEO INPUT:⁵
 HARMONIC RADIATION:

AURAL PERFORMANCE

POWER OUTPUT:
 OUTPUT IMPEDANCE:
 AUDIO INPUT:
 FREQUENCY DEVIATION:
 INPUT IMPEDANCE:
 PRE-EMPHASIS:
 FREQUENCY RESPONSE:
 DISTORTION:
 FM NOISE:
 AM NOISE:⁶
 FREQUENCY STABILITY:⁷

SERVICE CONDITIONS

AMBIENT TEMPERATURE:
 AMBIENT HUMIDITY RANGE:
 ALTITUDE:
 PHYSICAL AND MECHANICAL DIMENSIONS:

ELECTRICAL REQUIREMENTS:

FCC

50 kW peak.
 50 ohms. Output connector: 3/8" EIA standard.
 174-216 MHz (Channels 7-13).
 ±250 Hz (maximum variation over 30 days).
 3% or less.
 Less than 2%.
 —3.58 MHz—42 dB or better
 —1.25 MHz and lower—23 dB or better
 Carrier to —0.75 MHz±0.5 dB
 Carrier0 dB reference
 Carrier to +4.20 MHz±0.5 dB
 +4.75 MHz and higher—30 dB or better
 ±0.75 dB.
 1% of sync peak.
 0.5 dB or better.
 1.0 dB or better.
 ±1° or better.
 ±3° or better.
 —55 dB or better (RMS) below sync level.
 2† 2%, 12.5† less than 5% baseline disturbance.
 .05 to 2.1 MHz: ±40 ns
 at 3.58 MHz: ±30 ns
 at 4.18 MHz: ±60 ns
 (referenced to standard curve—FCC).
 75 ohm system.
 —80 dB.

5 kW of diplexer output. (10 kW optional).
 50 ohms. Output connector: 3/8" EIA Std.
 +10 dBm, ±2 dB.
 ±25 kHz.
 600 ohms.
 75 microseconds.
 ±0.5 dB rel. to pre-emphasis (30-15,000 Hz).
 0.5% or less after 75 microseconds de-emphasis with ±25 kHz deviation
 —60 dB or better rel. to ±25 kHz dev.
 —55 dB relative to 100% modulation.
 ±250 Hz.

0° to +45°C (at sea level).
 0 to 95% relative humidity.
 Sea level to 7500 ft.
 106"W x 32.1"D x 72"H. Weight: 2600 lbs.
 Power supply: 70"W x 35"D x 52"H.
 Weight: 2600 lbs.
 Power input: 480 Volts, ±25 Volts and 208/240 volts,
 ±11 volts, 3 phase, 60 Hz. Power consumption:
 125 kVA, black picture. Power factor: .9 or better.

SPECIFICATIONS SUBJECT TO CHANGE WITHOUT NOTICE.

- ¹ After initial aging of 60 days.
- ² Measured at 65% and 15% of modulation. Reference 100%=peak of sync.
- ³ Maximum variation of sub-carrier amplitude from 75% to 10% of mod. Sub-carrier mod. percentage: 10% peak to peak.
- ⁴ Maximum variation of sub-carrier phase with respect to burst for mod. percentage from 75% to 10%. Sub-carrier mod. percentage: 10% peak to peak.
- ⁵ Bridging, loop through input with—30 dB or better return loss up to 5.5 MHz.
- ⁶ After de-emphasis.
- ⁷ Relative to frequency offset by 4.5 MHz (FCC) from the visual carrier.

ORDERING INFORMATION

TV-50H, 50 kW VHF-TV transmitter for FCC standards service, Channels 7-13, with operating tubes, transistors, IC's, solid-state rectifiers, crystals, required pre-correction circuitry, low-level vestigial sideband filter, harmonic and color notch filters 994-8225-001
 TVD-100H, 100 kW dual VHF-TV transmitter for FCC standards service, Channels 7-13, equipped as above 994-8457-001



HARRIS

TVD-50H

**50-Kilowatt Dual
VHF High Band
Color Television
Transmitter**

- Two independent, complete 25-kilowatt transmitters for total redundancy and on-the-air reliability
- "Hot" standby exciters, modulators and sideband filter for maximum redundancy
- Harris' Dualtran output switching system allows parallel, single transmitter or alternate/main operation
- Advanced Transversal SideBand (TSB) filters—no group delay, no tuning adjustments required
- Solid-State exciters and IPAs enhance reliability
- IF Modulation of the visual and aural carriers for superb color and sound reproduction
- Superior color performance—minimal corrections required
- Easily interfaced with ATS and remote control systems
- Simple solid-state logic control
- Fast turn-on time
- Modular pre-wired cabinets for fast and easy installation

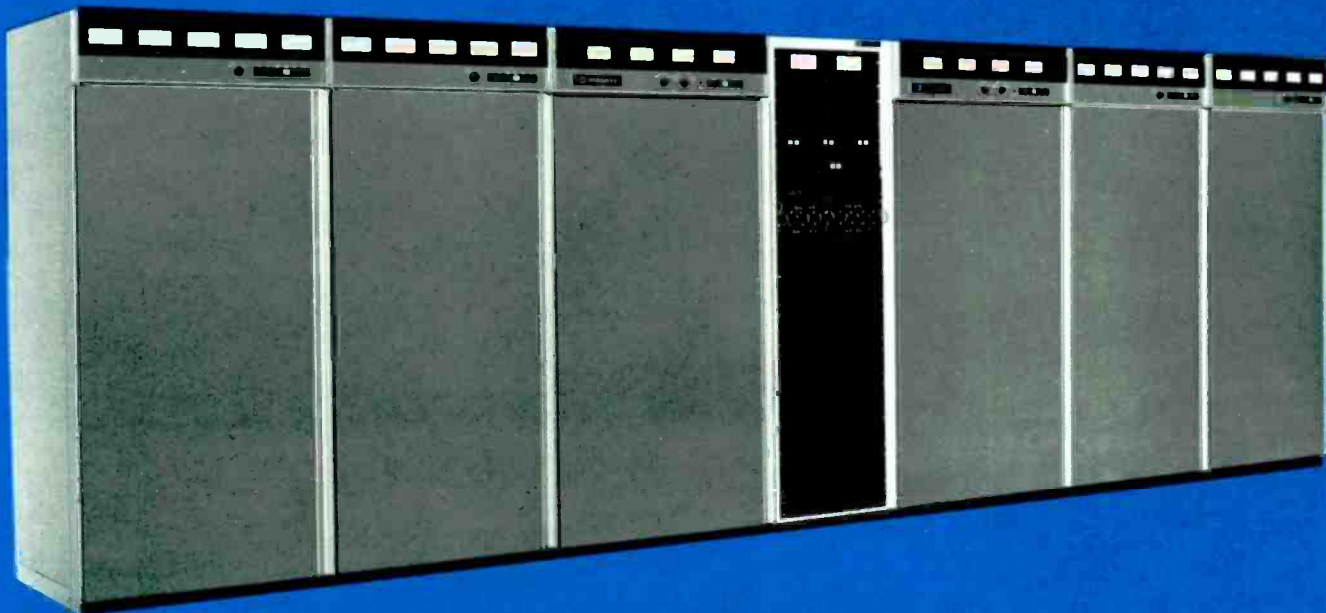

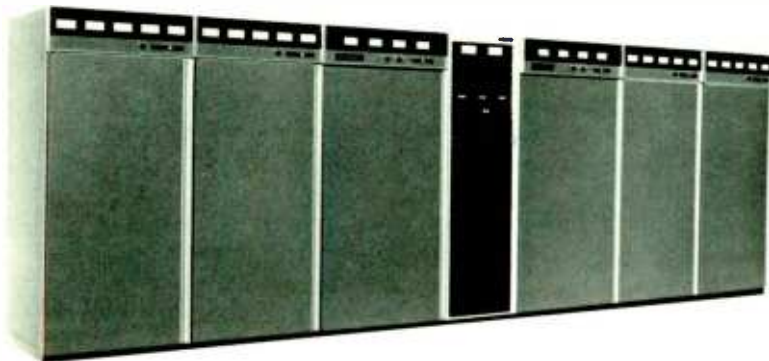

TOTAL REDUNDANCY FOR COMPLETE RELIABILITY

The Harris TVD-50H, 50-kilowatt dual high band VHF TV transmitter, is designed for television broadcasters who want the utmost in reliability and performance—with the flexibility for remote control or automatic operation. This dual transmitter consists of two completely independent 25-kilowatt transmitters operating in parallel, combined through the Harris unique-design Dualtran RF switching system.

With the TVD-50H you get two aural exciter/modulators, two visual exciter/modulators, two TSB filters, two solid-state visual and aural IPA's, two visual and aural PA's, and two HV power supplies—in short, total redundancy! Complete reliability!

The Dualtran switching system is factory assembled in one cabinet, and can be supplied to interface with either a hybrid or a notch diplexer.

IF (intermediate frequency) Modulation, low-level sideband filtering, true linear operation of power amplifiers and solid-state visual and aural exciter/modulators combine to provide outstanding color and sound fidelity. As no envelope delay correction or adjustments are required for the solid-state Transversal SideBand filter(s), stability, reliability and color quality are greatly enhanced.

Frequency adjustment, power output control and amplifier tuning are straightforward and uncomplicated, while design simplicity and conservatively rated components in the TVD-50H assure long-term "hands-off" operation and minimum maintenance. DC filaments in the visual and aural stages provide improved signal-to-noise ratios.

The transmitter is FCC type accepted, and factory power testing assures performance to specifications.

AUTOMATIC SWITCHING. In the event of a malfunction of one-half of the parallel combination, the Harris TVD-50H offers automatic and instantaneous reduction to

one-fourth authorized power. This function will occur without interruption of the carrier. With the touch of a button, half-power operation is achieved in less than two seconds.

Visual and aural exciters are connected in a hot standby condition, and will automatically switch in less than 10 milliseconds in case of failure in either unit. In all modes, aural follows visual for simplified logic control and reliable operation.

OPERATING VERSATILITY. Four modes of operation may be obtained electrically by means of control pushbuttons on the output switcher; by control buttons on the transmitter control panel; or by remote control. These are:

- Transmitters A and B combined On-Air.
- Transmitter A On-Air and transmitter B into the station loads.
- Transmitter B On-Air and transmitter A into the station loads.
- Transmitters A and B combined to the station loads (test mode).

The switching operation from one mode to any other mode requires less than two seconds.

When using a notch diplexer, three other operating modes may be selected manually by changing links on the Dualtran output switching cabinet: transmitters A and B combined and diplexed to the station loads; transmitter A diplexed into station loads; and transmitter B diplexed into station loads.

EXCELLENT PERFORMANCE

Surface acoustic wave technology is applied to vestigial sideband filtering in the visual exciter. The Transversal SideBand (TSB) filter displays a near-ideal bandpass function for CCIR Systems "M" (FCC) and "B" bandwidths. This, combined with the filter's true linear phase characteristic, offers excellent reproduction of pulse waveforms and encoded color information without adjustment.

DUALTRAN OUTPUT SWITCHER CABINET

All switches, patch panels, combiners, reject and dummy loads, couplers, sensors and control logic are factory assembled, tested and optimized for best VSWR across the channel. The only external transmission line connections are for the transmitters, antenna and diplexer. This saves installation labor and time, and insures excellent performance without field optimization. Motorized coaxial switches accomplish RF switching at the push of a button on the output switcher control panel, center transmitter control cabinet or via remote control. Solid-state control logic automatically routes command signals to turn off plate voltages, operate proper coaxial switches and re-apply plate voltage...all in two seconds or less.

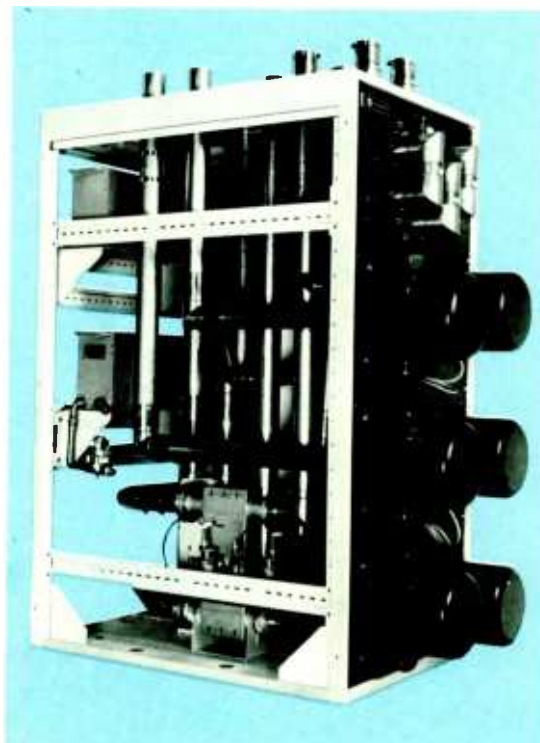

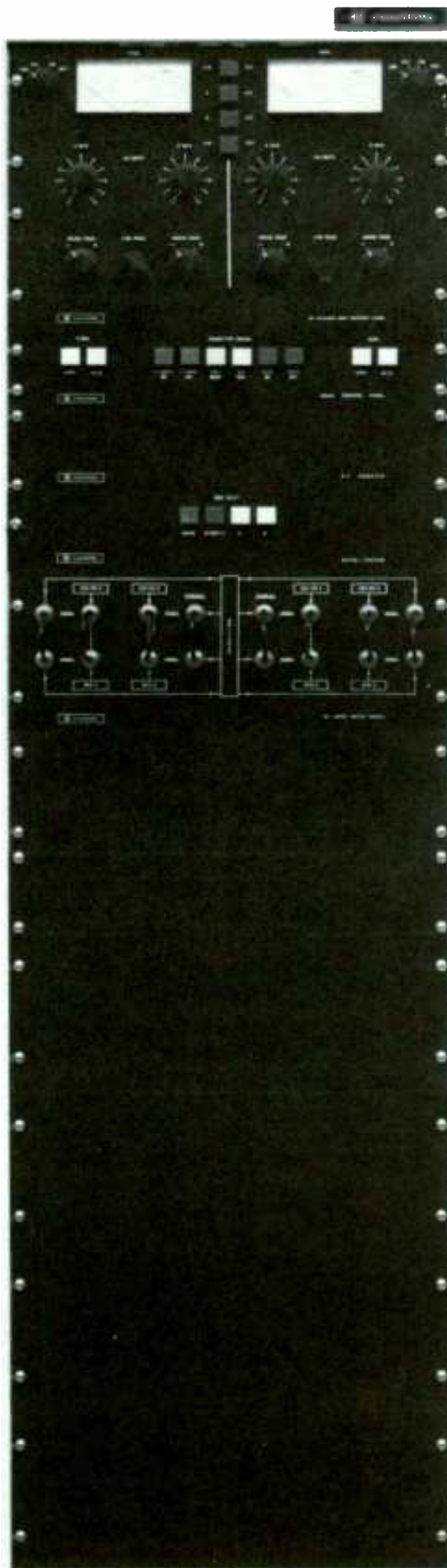

CENTER CONTROL CABINET

All adjustments and control of dual transmitter operation can be accomplished from the control cabinet, supplied as standard equipment in all Harris Dualtran systems. This cabinet is normally mounted between the two independent transmitters to provide a pleasing installation. The RF phasing and control panel, the exciter/modulator switcher, and the local control panel are standard equipment with the Harris Dualtran systems.

RF Phasing and Control Panel: Here the output of the on-air exciter/modulator is split to drive the two transmitters. Phasing controls and attenuators provide adjustment of the two signals to assure maximum combined transmitter output. Switchable visual and aural power meters are provided to monitor combined forward, combined reflected and reject power levels. Also, Dualtran output switcher control logic pushbuttons on this panel can select "A + B Air", "A Air", "B Air" or "A + B Test" modes.

Local Control Panel: Provides simultaneous control of both transmitters including filament and plate on/off and aural and visual raise/lower functions. All system remote control terminals are available on this panel.

Exciter/Modulator Switcher: Solid-state control logic provides manual or automatic switching of the two exciter/modulators from "hot standby" to "on-air" status in case of exciter failure. Switching occurs in 10 milliseconds for no perceptible loss of signal.

Input Patch Panel (Optional): Permits bypassing the exciter/modulator switcher via BNC cables to patch any combination of aural/visual exciters to any transmitter. This provides extra flexibility for emergency situations and for system maintenance and testing.

RF Input Bypass Switcher (Optional—Not Shown): In single transmitter modes this switcher removes the 3 dB coupler in the RF phasing/control panel from input circuitry, thereby putting full rated power of any one transmitter on the air.

TVD-50H

SOLID-STATE IPA

Each 25-kilowatt transmitter features a solid-state IPA to greatly enhance reliability and reduce tuning requirements.

The solid-state IPAs contain broadband amplifiers, so that periodic bandpass adjustments are not required—and they are fully protected against damage caused by overloads or load variations. For added transmitter protection, RF drive is applied over a one to two second interval, which permits DC voltage stabilization before full RF drive application to power amplifiers. The IPAs are fully metered for monitoring and maintenance, while excellent cooling helps maintain long transistor life.

Each 25-kilowatt transmitter employs a single-ended visual PA (8916 tetrode), and DC filaments in every stage for an excellent signal-to-noise ratio.

TRANSVERSAL SIDE BAND (TSB) FILTER

The Harris solid-state sideband filter is an advanced surface acoustic wave design, and shapes visual sidebands at the IF frequency, rather than "on frequency" at the full output power of the transmitter. Unlike previous VSB filters, the TSB filter has an inherent linear phase characteristic and requires no group delay correction or tuning.

SOLID-STATE VISUAL AND AURAL EXCITER/MODULATORS

The Harris solid-state MCP-1V visual exciter/modulator is an independent, self-contained unit which provides a fully processed on-channel picture signal. Power output can be varied up to one watt with a single front panel control, or from a remote location, without retuning of any kind.

The MCP-1V provides great reliability and stability, excellent frequency response, and truest color quality. It is designed for minimum maintenance and set-up time, and for remote control and unattended operation. This is all made possible through the use of the latest design techniques, including Harris' solid-state TSB filter.

The Harris aural exciter/modulator is a solid-state, self-contained unit which furnishes a fully processed aural signal at a level up to 10 watts. Power output can be set with a single knob on the front panel, or by remote control, with no need for retuning. It is mounted in a pull-out drawer, and may be operated with the drawer extended for test purposes.

INTERMEDIATE FREQUENCY (IF) MODULATION

One of the features of the TVD-50H is its true low-level IF Modulation, which offers a top quality picture, and excels in electrical performance, reliability and simplicity of operation.

Due to the low-level techniques, which include the use of devices such as an extremely linear broadband diode ring modulator, low-level sideband filtering and very linear broadband amplifiers, the color signal is a faithful reproduction of the signal applied to the transmitter input.

SOLID-STATE CONTROL CIRCUITS

Solid-state memory, timing and logic circuits offer complete and foolproof control of all transmitter functions. Built-in memory circuitry enables the entire transmitter to return to the air automatically in the state it was operating prior to an AC power interruption.

The control logic, in addition to commanding normal AC control functions, is also used to visually indicate, through indicator lights, the operating status of the transmitter system. These indicator lights allow easy isolation of circuit faults, and are easily removed.

REMOTE CONTROL, UNATTENDED AND AUTOMATIC OPERATION

All control, metering and monitoring circuits have been designed specifically for remote control and ATS. The power controls are motor driven and the necessary remote control sampling points are built-in on accessible terminal boards. Today, Harris TV transmitters are being operated successfully worldwide with a variety of remote control systems.

AUTOMATIC POWER CONTROL

Automatic gain control of all RF amplifier stages, in conjunction with the exciters' automatic power control, insures essentially constant power output, even with variations in line voltages. This feature is standard in the TVD-50H.

STABILITY

One factor assuring RF stability is the use of solid-state IPA'S and conservatively rated Type 8988, 8807 and 8916 ceramic tetrodes operating as VHF linear amplifiers. These amplifier stages operate in a common grid and screen configuration and tube neutralization is not required.

EXCELLENT COOLING SYSTEM

The cooling system of the TVD-50H is quiet and efficient, and employs direct drive blowers, with the motors fully protected by automatic reset devices.

POWER SUPPLIES

The HV power supplies for the TVD-50H visual and aural PAs exhibit very low ripple content. They are designed for excellent regulation and low video impedance for optimum picture performance. In addition, for ease of maintenance, the two power supplies, including transformers and solid-state rectifiers, are housed in two separate assemblies, mounted externally from the transmitter. Routine maintenance access is provided by removable panels.

Vacuum tube filaments in the visual transmitters are operated from DC power supplies to maximize the output signal-to-noise ratio. Grid and screen supplies are 100% solid state.

The visual and aural exciters have their own independent, solid-state regulated power supplies.

EASE OF MAINTENANCE

Convenient access to components is provided, permitting the transmitter to be easily maintained. Visual and aural exciters slide out and can operate independently from the transmitter outside the cabinet. Various exciter circuits, such as oscillators, modulators and processing circuitry, are of modular construction and can be removed for maintenance or replacement.

Easy-to-read, eye-level 4-inch meters are used to monitor required transmitter functions. Meter panels are of double-hinged construction for easy access during maintenance.

TVD-50H

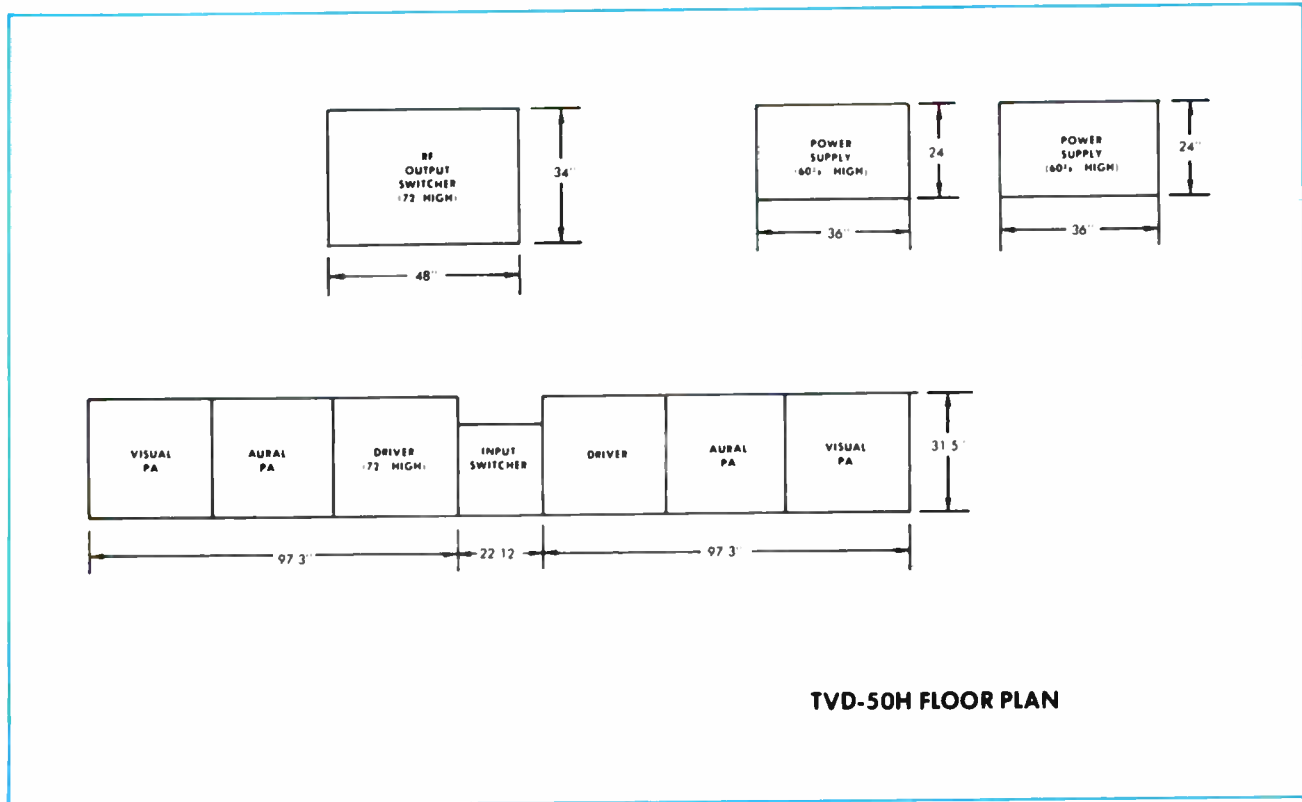
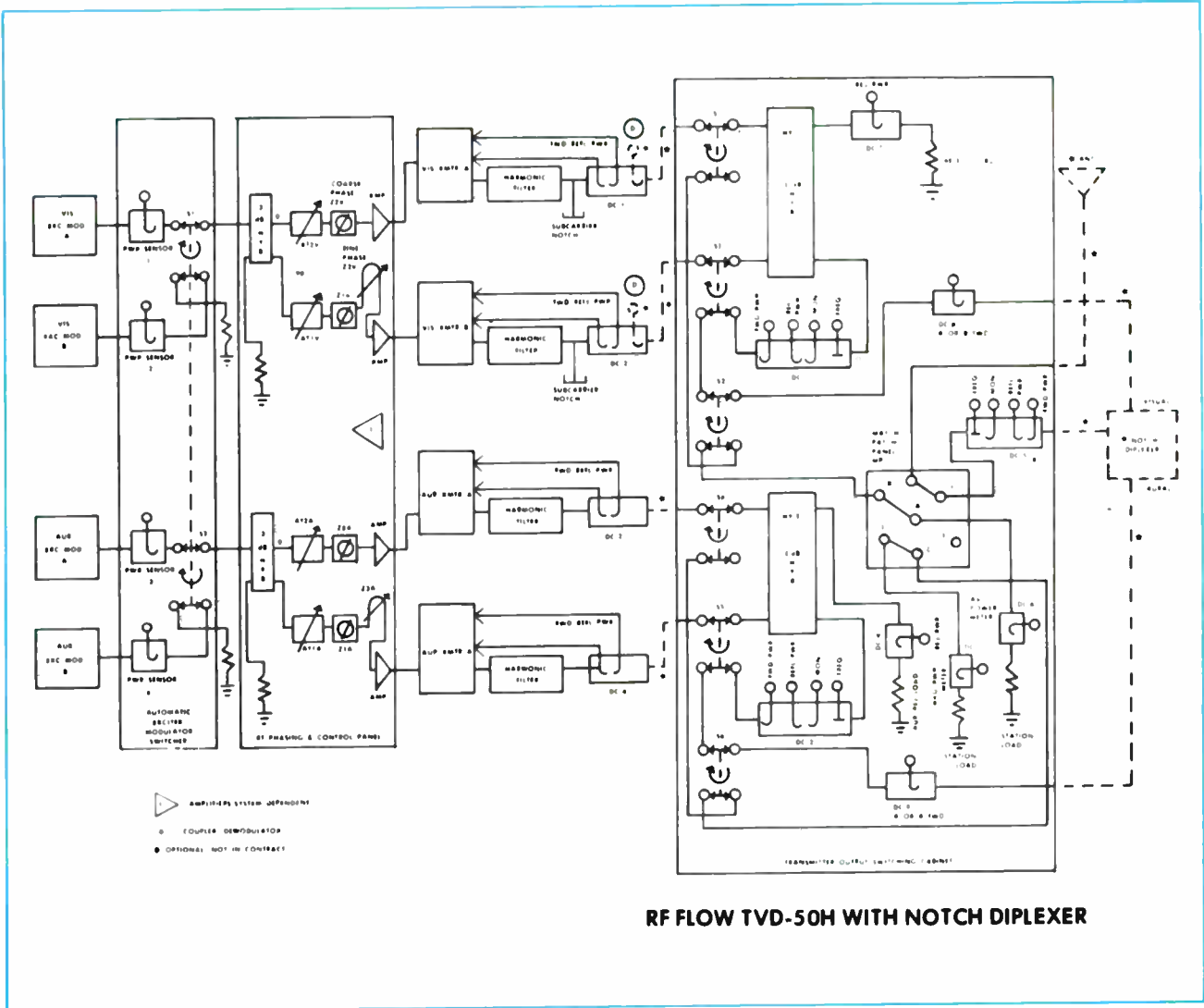

TVD-50H SPECIFICATIONS

VISUAL PERFORMANCE

POWER OUTPUT:
OUTPUT IMPEDANCE:
FREQUENCY RANGE:
CARRIER STABILITY:¹
REG. OF RF OUTPUT POWER (Black to white pic.):
VARIATION OF OUTPUT (over one frame):
VISUAL SIDEBAND RESPONSE:

FREQUENCY RESPONSE VS. BRIGHTNESS:²
VISUAL MODULATION CAPABILITY:
DIFFERENTIAL GAIN:³
LINEARITY (LOW FREQUENCY):
INCIDENTAL PHASE MODULATION:

DIFFERENTIAL PHASE:⁴
SIGNAL-TO-NOISE RATIO:
K FACTORS:
EQUIVALENT ENVELOPE DELAY:

VIDEO INPUT:⁵
HARMONIC RADIATION:

AURAL PERFORMANCE

POWER OUTPUT:
OUTPUT IMPEDANCE:
AUDIO INPUT:
FREQUENCY DEVIATION:
INPUT IMPEDANCE:
PRE-EMPHASIS:
FREQUENCY RESPONSE:
DISTORTION:

FM NOISE:
AM NOISE:⁶
FREQUENCY STABILITY:⁷

SERVICE CONDITIONS

AMBIENT TEMPERATURE:
AMBIENT HUMIDITY RANGE:
ALTITUDE:

PHYSICAL AND MECHANICAL DIMENSIONS:

ELECTRICAL REQUIREMENTS:

FCC (System "M")

50 kW peak.
 50 ohms. Output connector: 3 1/8" EIA standard.
 174-216 MHz (Channels 7-13).
 ±250 Hz (maximum variation over 30 days).
 3% or less.
 Less than 2%.
 —3.58 MHz —42 dB or better
 —1.25 MHz and lower —26 dB or better
 Carrier to —0.75 MHz ±0.5 dB
 Carrier 0 dB reference
 Carrier to +4.20 MHz ±0.5 dB
 +4.75 MHz and higher —30 dB or better
 ±0.75 dB.
 1% or better.
 3% or better.
 1.0 dB or better.
 ±3° or better.
 ±1° or better.
 —55 dB or better (RMS) below sync level.
 2± 2%, 12.5± less than 5% baseline disturbance.
 .05 to 2.1 MHz: ± 40 ns.
 at 3.58 MHz: ± 30 ns.
 at 4.18 MHz: ± 60 ns.
 (referenced to standard curve—FCC).
 75 ohm system.
 —80 dB.
 10 kW at diplexer output.
 50 ohms. Output connector: 3 1/8" EIA Std.
 +10 dBm, ±2 dB.
 ±25 kHz.
 600 ohms.
 75 microseconds.
 ±0.5 dB rel. to pre-emphasis (30-15,000 Hz).
 0.5% or less after 75 microseconds de-emphasis
 with ±25 kHz deviation.
 —60 dB or better rel. to ±25 kHz dev.
 —55 dB relative to 100% modulation.
 ±250 Hz.

—10° to +50°C (14° to 122°F).
 0 to 95% relative humidity.
 Sea level to 7500 ft.
 216.72" W x 31.5" D x 72.0" H. Weight: 6,770 lbs.
 Power supplies (2) each: 36" W x 24" D x 60.4" H.
 Weight: 950 lbs.
 Output switcher: 34" W x 48" D x 72" H. Weight:
 1,350 lbs.
 Power input: 208/240 volts, ±11 volts, 3 phase,
 50/60 Hz. Power consumption (approx.): 116
 kVA, black picture, 10% aural; 98 kVA, average
 picture (50% APL), 10% aural; 124 kVA, black
 picture at 20% aural; 106 kVA, average picture
 at 20% aural.

SPECIFICATIONS SUBJECT TO CHANGE WITHOUT NOTICE.

- ¹ After initial aging of 60 days.
- ² Measured at 65% and 15% of modulation. Reference 100%=peak of sync.
- ³ Maximum variation of sub-carrier amplitude from 75% to 10% of mod. Sub-carrier mod. percentage: 10% peak to peak.
- ⁴ Maximum variation of sub-carrier phase with respect to burst for mod. percentage from 75% to 10%. Sub-carrier mod. percentage: 10% peak to peak.
- ⁵ Bridging, loop through input with —30 dB or better return loss up to 5.5 MHz.
- ⁶ After de-emphasis.
- ⁷ Relative to frequency offset by 4.5 MHz (FCC) from the visual carrier.

ORDERING INFORMATION

TVD-50H, 50 kW dual VHF-TV transmitter for FCC standards service, Channels 7-13, with operating tubes, semiconductors, crystals, VSB filter, color notch filter, harmonic filters, input and output switchers 994-8408-001



TVD-36H

36-Kilowatt Dual VHF High Band Color Television Transmitter

- Two independent, complete 13-kilowatt transmitters for total redundancy and on-the-air reliability
- "Hot" standby exciters, modulators and sideband filter for maximum redundancy
- Harris' Dualtran output switching system allows parallel, single transmitter or alternate/main operation
- Advanced Transversal SideBand (TSB) filters—no group delay, no tuning adjustments required
- Solid-State exciters and IPAs enhance reliability
- IF Modulation of the visual and aural carriers for superb color and sound reproduction
- Superior color performance—minimal corrections required
- Easily interfaced with ATS and remote control systems
- Simple solid-state logic control
- Fast turn-on time
- Modular pre-wired cabinets for fast and easy installation

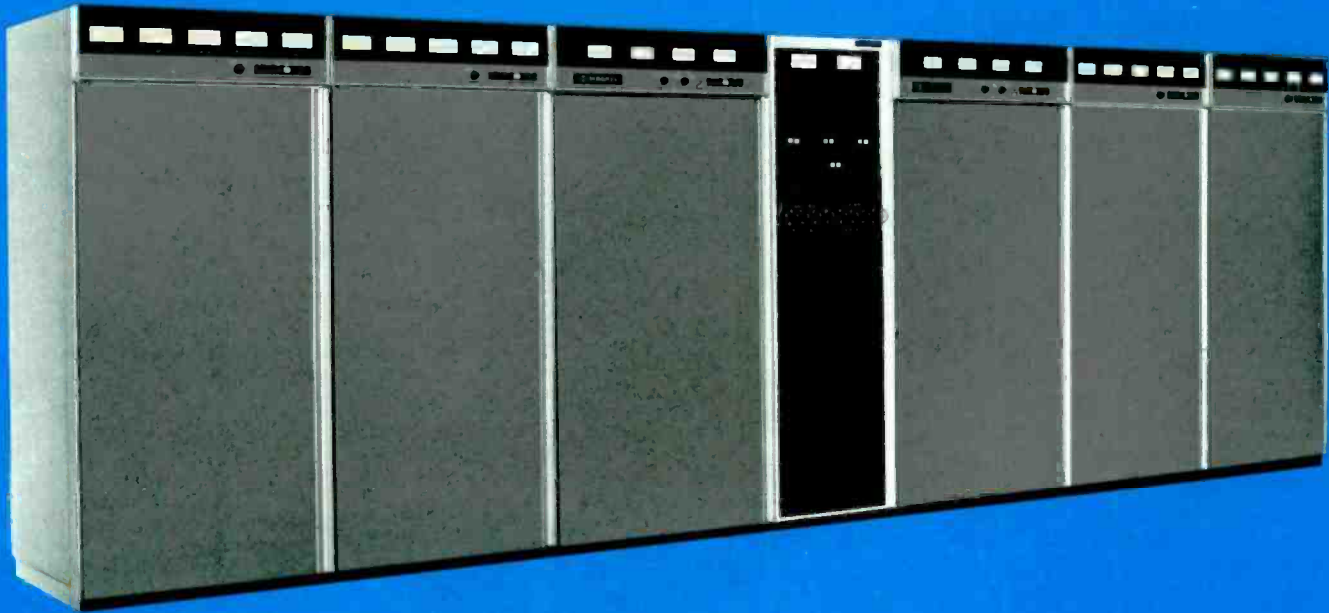

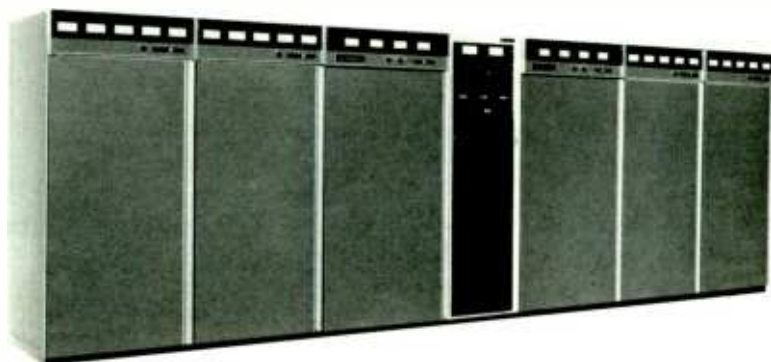

TOTAL REDUNDANCY FOR COMPLETE RELIABILITY

The Harris TVD-50H, 50-kilowatt dual high band VHF TV transmitter, is designed for television broadcasters who want the utmost in reliability and performance—with the flexibility for remote control or automatic operation. This dual transmitter consists of two completely independent 25-kilowatt transmitters operating in parallel, combined through the Harris unique-design Dualtran RF switching system.

With the TVD-50H you get two aural exciter/modulators, two visual exciter/modulators, two TSB filters, two solid-state visual and aural IPA's, two visual and aural PA's, and two HV power supplies—in short, total redundancy! Complete reliability!

The Dualtran switching system is factory assembled in one cabinet, and can be supplied to interface with either a hybrid or a notch diplexer.

IF (intermediate frequency) Modulation, low-level sideband filtering, true linear operation of power amplifiers and solid-state visual and aural exciter/modulators combine to provide outstanding color and sound fidelity. As no envelope delay correction or adjustments are required for the solid-state Transversal SideBand filter(s), stability, reliability and color quality are greatly enhanced.

Frequency adjustment, power output control and amplifier tuning are straightforward and uncomplicated, while design simplicity and conservatively rated components in the TVD-50H assure long-term "hands-off" operation and minimum maintenance. DC filaments in the visual and aural stages provide improved signal-to-noise ratios.

The transmitter is FCC type accepted, and factory power testing assures performance to specifications.

AUTOMATIC SWITCHING. In the event of a malfunction of one-half of the parallel combination, the Harris TVD-50H offers automatic and instantaneous reduction to

one-fourth authorized power. This function will occur without interruption of the carrier. With the touch of a button, half-power operation is achieved in less than two seconds.

Visual and aural exciters are connected in a hot standby condition, and will automatically switch in less than 10 milliseconds in case of failure in either unit. In all modes, aural follows visual for simplified logic control and reliable operation.

OPERATING VERSATILITY. Four modes of operation may be obtained electrically by means of control pushbuttons on the output switcher; by control buttons on the transmitter control panel; or by remote control. These are:

- Transmitters A and B combined On-Air
- Transmitter A On-Air and transmitter B into the station loads.
- Transmitter B On-Air and transmitter A into the station loads.
- Transmitters A and B combined to the station loads (test mode).

The switching operation from one mode to any other mode requires less than two seconds.

When using a notch diplexer, three other operating modes may be selected manually by changing links on the Dualtran output switching cabinet: transmitters A and B combined and diplexed to the station loads; transmitter A diplexed into station loads; and transmitter B diplexed into station loads.

EXCELLENT PERFORMANCE

Surface acoustic wave technology is applied to vestigial sideband filtering in the visual exciter. The Transversal SideBand (TSB) filter displays a near-ideal bandpass function for CCIR Systems "M" (FCC) and "B" bandwidths. This, combined with the filter's true linear phase characteristic, offers excellent reproduction of pulse waveforms and encoded color information without adjustment.

DUALTRAN OUTPUT SWITCHER CABINET

All switches, patch panels, combiners, reject and dummy loads, couplers, sensors and control logic are factory assembled, tested and optimized for best VSWR across the channel. The only external transmission line connections are for the transmitters, antenna and diplexer. This saves installation labor and time, and insures excellent performance without field optimization. Motorized coaxial switches accomplish RF switching at the push of a button on the output switcher control panel, center transmitter control cabinet or via remote control. Solid-state control logic automatically routes command signals to turn off plate voltages, operate proper coaxial switches and re-apply plate voltage...all in two seconds or less.

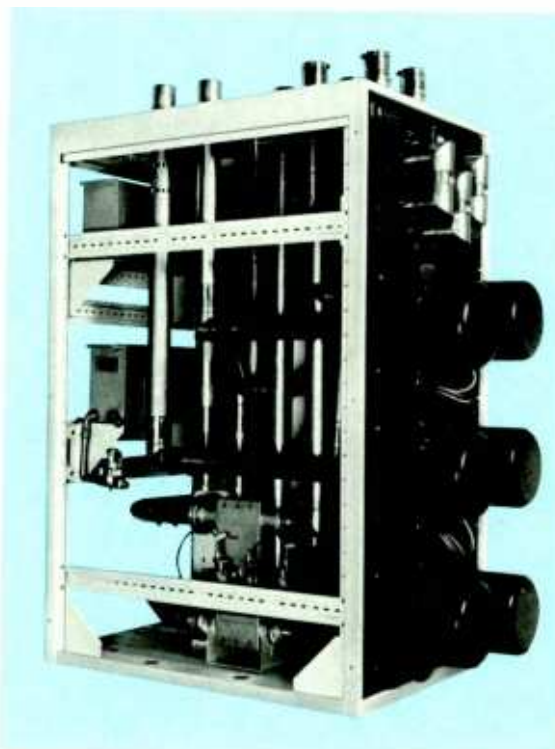

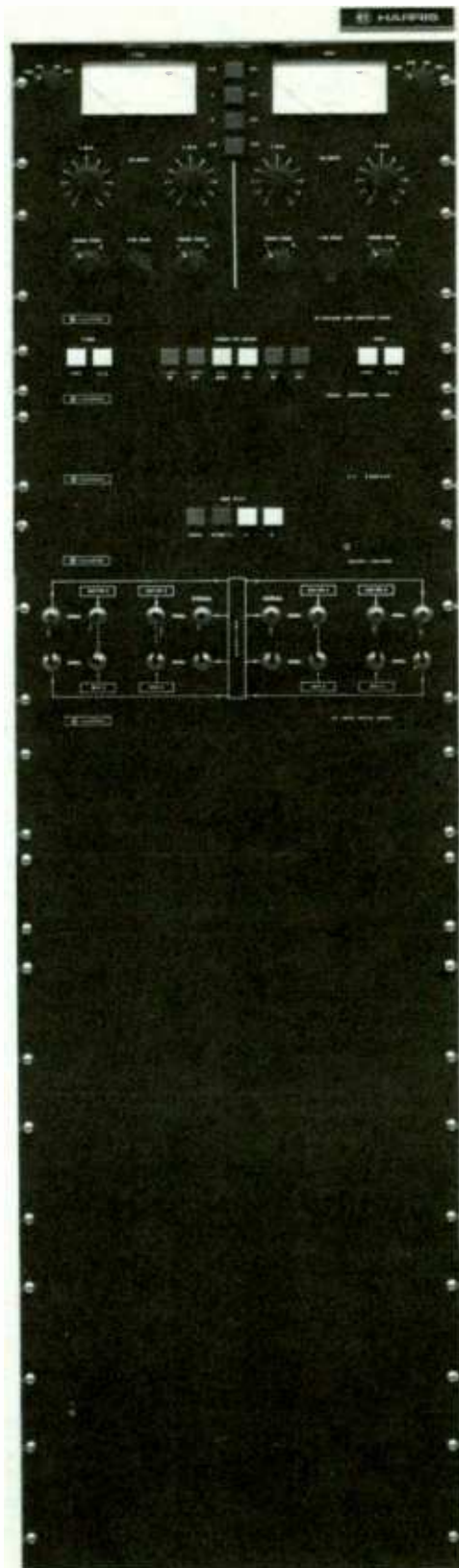

CENTER CONTROL CABINET

All adjustments and control of dual transmitter operation can be accomplished from the control cabinet, supplied as standard equipment in all Harris Dualtran systems. This cabinet is normally mounted between the two independent transmitters to provide a pleasing installation. The RF phasing and control panel, the exciter/modulator switcher, and the local control panel are standard equipment with the Harris Dualtran systems.

RF Phasing and Control Panel: Here the output of the on-air exciter/modulator is split to drive the two transmitters. Phasing controls and attenuators provide adjustment of the two signals to assure maximum combined transmitter output. Switchable visual and aural power meters are provided to monitor combined forward, combined reflected and reject power levels. Also, Dualtran output switcher control logic pushbuttons on this panel can select "A + B Air", "A Air", "B Air" or "A + B Test" modes.

Local Control Panel: Provides simultaneous control of both transmitters including filament and plate on/off and aural and visual raise/lower functions. All system remote control terminals are available on this panel.

Exciter/Modulator Switcher: Solid-state control logic provides manual or automatic switching of the two exciter/modulators from "hot standby" to "on-air" status in case of exciter failure. Switching occurs in 10 milliseconds for no perceptible loss of signal.

Input Patch Panel (Optional): Permits bypassing the exciter/modulator switcher via BNC cables to patch any combination of aural/visual exciters to any transmitter. This provides extra flexibility for emergency situations and for system maintenance and testing.

RF Input Bypass Switcher (Optional—Not Shown): In single transmitter modes this switcher removes the 3 dB coupler in the RF phasing/control panel from input circuitry, thereby putting full rated power of any one transmitter on the air.

TVD-36H

SOLID-STATE IPA

Each 18-kilowatt transmitter features a solid-state IPA to greatly enhance reliability and reduce tuning requirements.

The solid-state IPAs contain broadband amplifiers, so that periodic bandpass adjustments are not required—and they are fully protected against damage caused by overloads or load variations. For added transmitter protection, RF drive is applied over a one to two second interval, which permits DC voltage stabilization before full RF drive application to power amplifiers. The IPAs are fully metered for monitoring and maintenance, while excellent cooling helps maintain long transistor life.

Each 18-kilowatt transmitter employs a single-ended visual PA (8916 tetrode) and DC filaments in every stage for an excellent signal-to-noise ratio.

TRANSVERSAL SIDE BAND (TSB) FILTER

The Harris solid-state sideband filter is an advanced surface acoustic wave design, and shapes visual sidebands at the IF frequency, rather than "on frequency" at the full output power of the transmitter. Unlike previous VSB filters, the TSB filter has an inherent linear phase characteristic and requires no group delay correction or tuning.

SOLID-STATE VISUAL AND AURAL EXCITER/MODULATORS

The Harris solid-state MCP-1V visual exciter/modulator is an independent, self-contained unit which provides a fully processed on-channel picture signal. Power output can be varied up to one watt with a single front panel control, or from a remote location, without retuning of any kind.

The MCP-1V provides great reliability and stability, excellent frequency response, and truest color quality. It is designed for minimum maintenance and set-up time, and for remote control and unattended operation. This is all made possible through the use of the latest design techniques, including Harris' solid-state TSB filter.

The Harris aural exciter/modulator is a solid-state, self-contained unit which furnishes a fully processed aural signal at a level up to 10 watts. Power output can be set with a single knob on the front panel, or by remote control, with no need for retuning. It is mounted in a pull-out drawer, and may be operated with the drawer extended for test purposes.

INTERMEDIATE FREQUENCY (IF) MODULATION

One of the features of the TVD-36H is its true low-level IF Modulation, which offers a top quality picture, and excels in electrical performance, reliability and simplicity of operation.

Due to the low-level techniques, which include the use of devices such as an extremely linear broadband diode ring modulator, low-level sideband filtering and very linear broadband amplifiers, the color signal is a faithful reproduction of the signal applied to the transmitter input.

SOLID-STATE CONTROL CIRCUITS

Solid-state memory, timing and logic circuits offer complete and foolproof control of all transmitter functions. Built-in memory circuitry enables the entire transmitter to return to the air automatically in the state it was operating prior to an AC power interruption.

The control logic, in addition to commanding normal AC control functions, is also used to visually indicate, through indicator lights, the operating status of the transmitter system. These indicator lights allow easy isolation of circuit faults, and are easily removed.

REMOTE CONTROL, UNATTENDED AND AUTOMATIC OPERATION

All control, metering and monitoring circuits have been designed specifically for remote control and ATS. The power controls are motor driven and the necessary remote control sampling points are built-in on accessible terminal boards. Today, Harris TV transmitters are being operated successfully worldwide with a variety of remote control systems.

AUTOMATIC POWER CONTROL

Automatic gain control of all RF amplifier stages, in conjunction with the exciters' automatic power control, insures essentially constant power output, even with variations in line voltages. This feature is standard in the TVD-36H.

STABILITY

One factor assuring RF stability is the use of solid-state IPA'S and conservatively rated Type 8988, 8807 and 8916 ceramic tetrodes operating as VHF linear amplifiers. These amplifier stages operate in a common grid and screen configuration and tube neutralization is not required.

EXCELLENT COOLING SYSTEM

The cooling system of the TVD-36H is quiet and efficient, and employs direct drive blowers, with the motors fully protected by automatic reset devices.

POWER SUPPLIES

The HV power supplies for the TVD-36H visual and aural PAs exhibit very low ripple content. They are designed for excellent regulation and low video impedance for optimum picture performance. In addition, for ease of maintenance, the two power supplies, including transformers and solid-state rectifiers, are housed in two separate assemblies, mounted externally from the transmitter. Routine maintenance access is provided by removable panels.

Vacuum tube filaments in the visual transmitters are operated from DC power supplies to maximize the output signal-to-noise ratio. Grid and screen supplies are 100% solid state.

The visual and aural exciters have their own independent, solid-state regulated power supplies.

EASE OF MAINTENANCE

Convenient access to components is provided, permitting the transmitter to be easily maintained. Visual and aural exciters slide out and can operate independently from the transmitter outside the cabinet. Various exciter circuits, such as oscillators, modulators and processing circuitry, are of modular construction and can be removed for maintenance or replacement.

Easy-to-read, eye-level 4-inch meters are used to monitor required transmitter functions. Meter panels are of double-hinged construction for easy access during maintenance.

TVD-36H SPECIFICATIONS

VISUAL PERFORMANCE

POWER OUTPUT:
OUTPUT IMPEDANCE:
FREQUENCY RANGE:
CARRIER STABILITY:¹
REG. OF RF OUTPUT POWER (Black to white pic.):
VARIATION OF OUTPUT (over one frame):
VISUAL SIDEBAND RESPONSE:

FREQUENCY RESPONSE VS. BRIGHTNESS:²
VISUAL MODULATION CAPABILITY:
DIFFERENTIAL GAIN:³
LINEARITY (LOW FREQUENCY):
INCIDENTAL PHASE MODULATION:

DIFFERENTIAL PHASE:⁴
SIGNAL-TO-NOISE RATIO:
K FACTORS:
EQUIVALENT ENVELOPE DELAY:

VIDEO INPUT:⁵
HARMONIC RADIATION:

AURAL PERFORMANCE

POWER OUTPUT:
OUTPUT IMPEDANCE:
AUDIO INPUT:
FREQUENCY DEVIATION:
INPUT IMPEDANCE:
PRE-EMPHASIS:
FREQUENCY RESPONSE:
DISTORTION:

FM NOISE:
AM NOISE:⁶
FREQUENCY STABILITY:⁷

SERVICE CONDITIONS

AMBIENT TEMPERATURE:
AMBIENT HUMIDITY RANGE:
ALTITUDE:

PHYSICAL AND MECHANICAL DIMENSIONS:

ELECTRICAL REQUIREMENTS:

FCC (System "M")

36 kW peak.
 50 ohms. Output connector: 3 1/8" EIA standard.
 174-216 MHz (Channels 7-13).
 ±250 Hz (maximum variation over 30 days).
 3% or less.
 Less than 2%.
 —3.58 MHz —42 dB or better
 —1.25 MHz and lower —26 dB or better
 Carrier to —0.75 MHz ±0.5 dB
 Carrier 0 dB reference
 Carrier to +4.20 MHz ±0.5 dB
 +4.75 MHz and higher —30 dB or better
 ±0.75 dB.
 1% or better.
 3% or better.
 1.0 dB or better.
 ±3° or better.
 ±1° or better.
 —55 dB or better (RMS) below sync level.
 2† 2%, 12.5† less than 5% baseline disturbance.
 .05 to 2.1 MHz: ± 40 ns.
 at 3.58 MHz: ± 30 ns.
 at 4.18 MHz: ± 60 ns.
 (referenced to standard curve—FCC).
 75 ohm system.
 —80 dB.

7.2 kW at diplexer output.
 50 ohms. Output connector: 3 1/8" EIA Std.
 +10 dBm, ±2 dB.
 ±25 kHz.
 600 ohms.
 75 microseconds.
 ±0.5 dB rel. to pre-emphasis (30-15,000 Hz).
 0.5% or less after 75 microseconds de-emphasis
 with ±25 kHz deviation.
 —60 dB or better rel. to ±25 kHz dev.
 —55 dB relative to 100% modulation.
 ±250 Hz.

—10° to +50°C (14° to 122°F).
 0 to 95% relative humidity.
 Sea level to 7500 ft.

216.72" W x 31.5" D x 72.0" H. Weight: 6,770 lbs.
 Power supplies (2) each: 36" W x 24" D x 60.4" H.
 Weight: 950 lbs.

Output switcher: 34" W x 48" D x 72" H. Weight:
 1,350 lbs.

Power input: 208/240 volts, ±11 volts, 3 phase,
 50/60 Hz. Power consumption (approx.): 110
 kVA, block picture, 10% aural; 93.6 kVA,
 average picture (50% APL), 10% aural; 118 kVA,
 black picture at 20% aural; 100.4 kVA, average
 picture at 20% aural.

SPECIFICATIONS SUBJECT TO CHANGE WITHOUT NOTICE.

- ¹ After initial aging of 60 days.
- ² Measured at 65% and 15% of modulation. Reference 100%=peak of sync.
- ³ Maximum variation of sub-carrier amplitude from 75% to 10% of mod. Sub-carrier mod. percentage: 10% peak to peak.
- ⁴ Maximum variation of sub-carrier phase with respect to burst for mod. percentage from 75% to 10%. Sub-carrier mod. percentage: 10% peak to peak.
- ⁵ Bridging, loop through input with —30 dB or better return loss up to 5.5 MHz.
- ⁶ After de-emphasis.
- ⁷ Relative to frequency offset by 4.5 MHz (FCC) from the visual carrier.

ORDERING INFORMATION

TVD-36H, 36 kW dual VHF-TV transmitter for FCC standards service, Channels 7-13, with operating tubes, semiconductors, crystals, VSB filter, color notch filter, harmonic filters, input and output switchers 994-8499-001



HARRIS

TV-35H

35-Kilowatt VHF
High Band
Color Television
Transmitter

- Ultra-linear driver with solid-state IPAs for maximum reliability and signal transparency
- Advanced Transversal SideBand (TSB) filter—requires no group delay correction, no tuning adjustments
- Superior color performance, with minimal correction circuitry
- IF Modulation of the visual and aural carriers
- Automatic power control insures constant power output
- Solid-state memory, timing and logic circuits
- Easily interfaced with ATS and remote control systems
- Parallel operation available for higher power and maximum redundancy

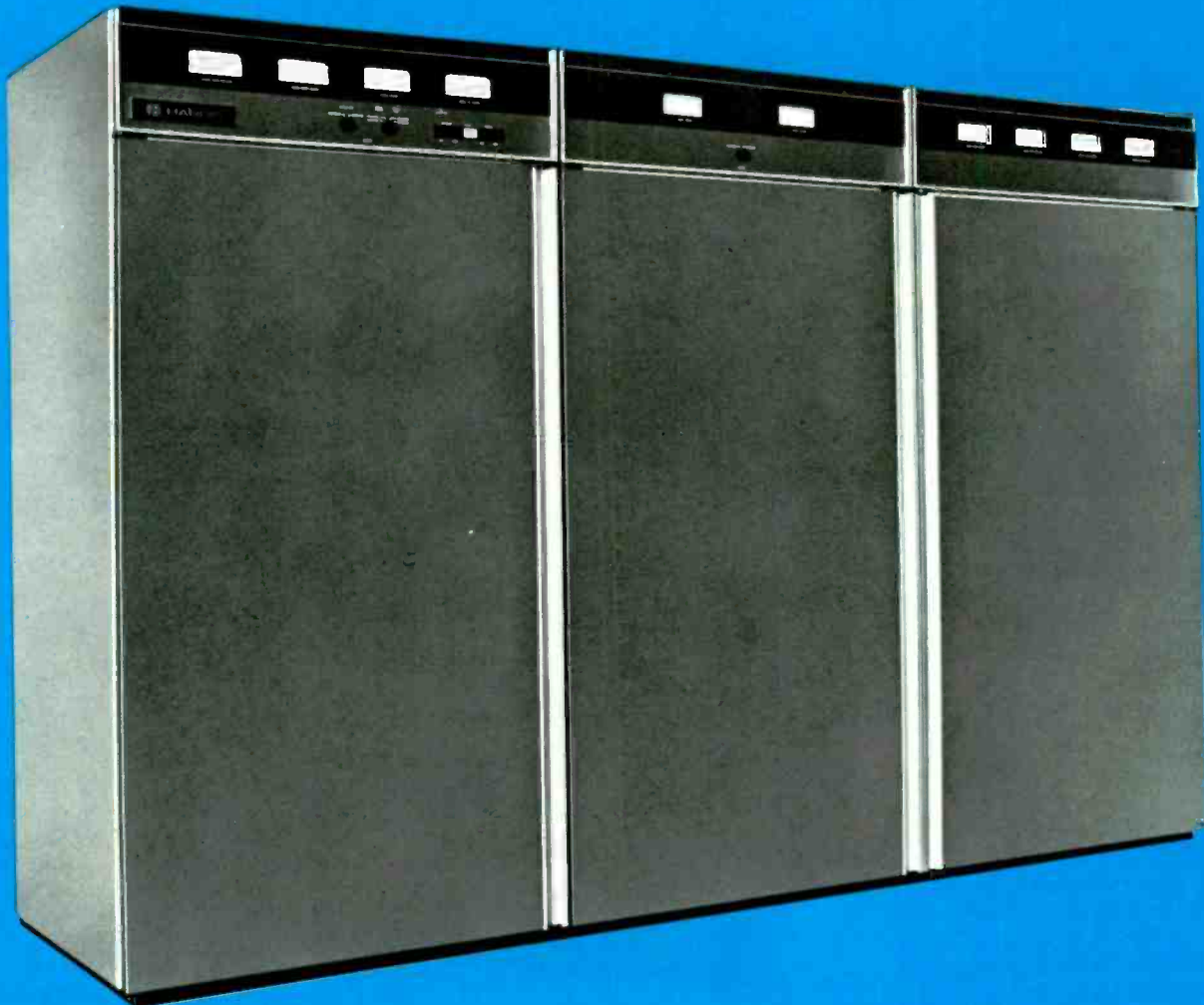

TV-35H . . . straightforward design for top

Harris' TV-35H, 35-kilowatt high band VHF television transmitter, is the most cost-effective TV transmitter available in its power range. Its straightforward design requires less complicated circuitry to meet the high performance standards demanded by today's discriminating broadcaster. And less complicated circuitry means greater reliability . . . the type of year-in, year-out dependability broadcasters need for impressive bottom line results.

The ultra-linear driver employs a broadband Class A solid-state IPA and a single conservatively-operated tetrode to drive the final visual amplifier. This means maximum linearity and signal transparency without the need for complicated correction circuitry . . . for unmatched reliability and maintainability.

The solid-state visual and aural IPAs not only enhance reliability, but also reduce tuning requirements, as they contain broadband amplifiers so that periodic bandpass adjustment is not required. They are fully protected against damage caused by overloads or load variations. For added transmitter protection, RF drive is applied over a one to two second interval, which permits DC voltage stabilization before full RF drive application to power amplifiers. The IPAs are fully metered for monitoring and maintenance, while excellent cooling helps maintain long transistor life.

Surface acoustic wave technology is applied to vestigial sideband filtering in the visual exciter. The Harris solid-state Transversal SideBand (TSB) filter displays a near-ideal bandpass function for Systems M (FCC) and B bandwidths. This, combined with the filter's true linear phase characteristic, offers excellent reproduction of pulse waveforms and encoded information. The TSB filter requires no group delay correction or tuning. Only 1½ square inches in size, it is located on a PC board in the visual exciter.

This compact transmitter requires only three tubes—visual PA, visual driver and aural PA—to provide a 35-kilowatt visual and a 4.5-kilowatt aural output. Under normal operating conditions the quick heat tubes permit transmitter turn-on within 120 seconds; faster turn-on times are possible in emergency conditions. A circulator between the visual stages minimizes retuning requirements after a tube change.

SUPERB COLOR PERFORMANCE

In addition to the ultra-linear driver, solid-state IPAs and TSB filter, Harris' TV-35H incorporates such features as IF Modulation, true linear operation of power amplifiers, and a solid-state visual exciter/modulator, to

provide the finest color performance available today.

As no envelope delay correction or adjustments are required for the sideband filter, stability, reliability and color quality are greatly enhanced. Frequency adjustment, power output control and amplifier tuning are straightforward and uncomplicated, while conservatively-rated components assure long-term "hands-off" operation and minimum maintenance.

The transmitter employs a single-ended visual PA (8984 tetrode), and DC filaments in every visual stage for an excellent signal-to-noise ratio.

SOLID-STATE VISUAL AND AURAL EXCITER/MODULATORS

The Harris MCP-1V visual exciter/modulator is an independent, self-contained unit which provides a fully processed on-channel picture signal. Power output can be varied up to one watt with a single front panel control, or from a remote location, without retuning of any kind.

The exciter is mounted in a pull-out drawer and may be operated outside the main transmitter for test purposes. A switch and meter mounted on the front panel permit monitoring exciter parameters. Power and video gain controls are motor driven with manual override provision to permit both local and remote adjustment.

The MCP-1V provides great reliability and stability, excellent frequency response, and truest color quality. It is designed for minimum maintenance and set-up time, and for remote control and unattended operation. This is all made possible through the use of the latest design techniques, including Harris' solid-state TSB filter.

The Harris aural exciter/modulator is a solid-state, self-contained unit which furnishes a fully processed aural signal at a level up to 10 watts. Power output can be set with a single knob on the front panel, or by remote control, with no need for retuning. It is mounted in a pull-out drawer, and may be operated with the drawer extended for test purposes.

INTERMEDIATE FREQUENCY (IF) MODULATION

One of the important features of the TV-35H is its true low-level IF Modulation, which offers a top quality picture, and excels in electrical performance, reliability and simplicity of operation.

In the TV-35H the visual and aural exciters generate fully modulated low-level IF signals.

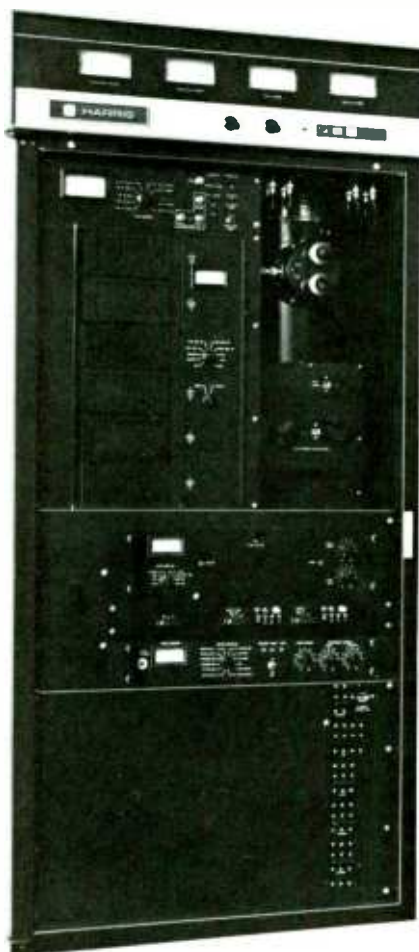

Ultra-linear driver with solid-state IPA.

reliability and color performance

The output of a common crystal controlled reference oscillator is used to raise the individual IF signal to the desired "on channel" output frequency.

Due to the low-level techniques, which include the use of devices such as an extremely linear broadband diode ring modulator, low-level sideband filtering and very linear broadband amplifiers, the color signal is a faithful reproduction of the signal applied to the transmitter input.

SOLID-STATE CONTROL CIRCUITS

Solid-state memory, timing and logic circuits offer complete and foolproof control of all transmitter functions. Built-in memory circuitry enables the entire transmitter to return to the air automatically in the state it was operating prior to an AC power interruption.

The control logic, in addition to commanding normal AC control functions, is also used to visually indicate, through indicator lights, the operating status of the transmitter system. These indicator lights allow isolation of circuit faults, and are easily removed.

REMOTE CONTROL, UNATTENDED AND AUTOMATIC OPERATION

All control, metering and monitoring circuits have been designed specifically for remote control and ATS. The power controls are motor driven and the necessary remote control sampling points are built-in on accessible terminal boards. Today, Harris TV transmitters are successfully operated worldwide with a variety of remote control systems, including the versatile, cost-saving Harris 9100 Facilities Control.

AUTOMATIC POWER CONTROL

Automatic gain control of all RF amplifier stages, in conjunction with the exciters' automatic power control, insures constant power output, even with variations in line voltages. This feature is standard in the TV-35H.

STABILITY

One factor assuring RF stability is the use of solid-state IPAs and conservatively rated Type 8988, 8807 and 8984 ceramic tetrodes operating as VHF linear amplifiers. These amplifier stages operate in a common grid and screen configuration and tube neutralization is not required.

EXCELLENT COOLING SYSTEM

The cooling system of the TV-35H is quiet and efficient, and employs direct drive blowers, with the motors fully protected by automatic reset devices.

POWER SUPPLIES

The HV power supply for the visual and aural PAs exhibits very low ripple content. It is designed for excellent regulation and low video impedance for optimum picture performance. In addition, for ease of maintenance, this power supply, including transformer and solid-state rectifiers, is housed in a single assembly, mounted externally from the transmitter. Routine maintenance access is provided by a removable panel.

Vacuum tube filaments in the visual and aural transmitters are operated from DC power supplies to maximize the output signal-to-noise ratios. Grid and screen supplies are 100% solid state.

The visual and aural exciters have their own independent, solid-state regulated power supplies.

EASE OF MAINTENANCE

Convenient access to components is provided, permitting the transmitter to be easily maintained. Visual and aural exciters

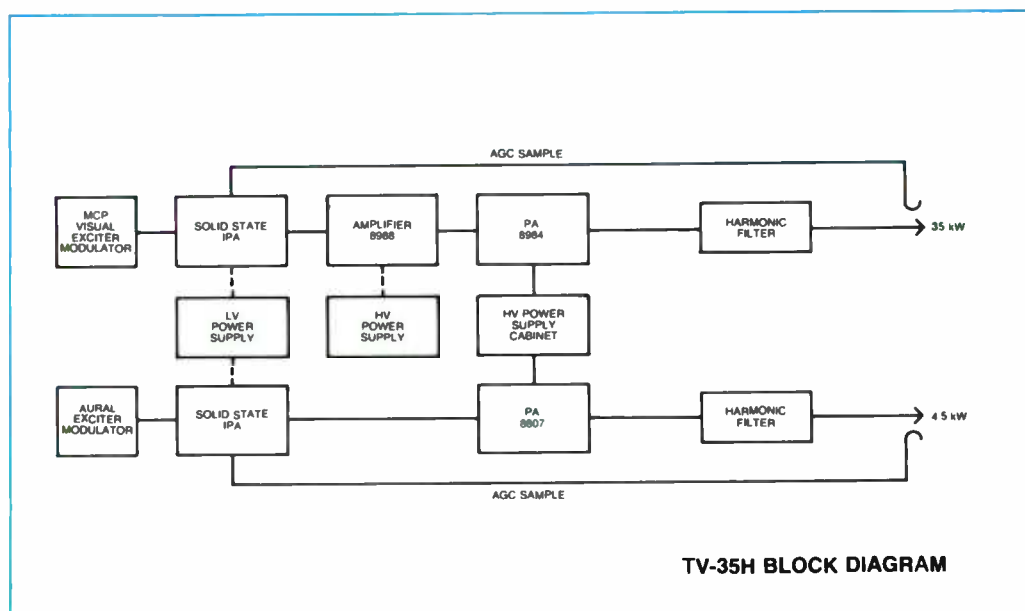

slide out and can operate independently from the transmitter outside the cabinet. Various exciter circuits, such as oscillators, modulators and processing circuitry, are of modular construction and can be removed for maintenance or replacement.

Easy-to-read, eye-level 4-inch meters are used to monitor required transmitter functions. Meter panels are of double-hinged construction for easy access during maintenance.

DUAL TRANSMITTER

The TV-35H is also available in a dual transmitter configuration, the TVD-70H, with 70 kW peak visual power. Using the famous Harris "Dualtran" RF switching concept, the TVD-70H can be used as main/alternate 35-kilowatt transmitters or as a full parallel 70-kilowatt transmitter for high power circularly polarized applications.

TV-35H SPECIFICATIONS

VISUAL PERFORMANCE

POWER OUTPUT:
LOAD IMPEDANCE:
FREQUENCY RANGE:
CARRIER FREQUENCY STABILITY:¹

REG. OF RF OUTPUT POWER (All black to all white pic.):
VARIATION OF OUTPUT (over one frame):
VISUAL SIDEBAND RESPONSE:²

FREQUENCY RESPONSE VS. BRIGHTNESS:³
VISUAL MODULATION CAPABILITY:
DIFFERENTIAL GAIN:⁴
INCIDENTAL PHASE MODULATION:
LINEARITY (LOW FREQUENCY):⁵
DIFFERENTIAL PHASE:⁴
SIGNAL-TO-NOISE:

Total random and periodic noise unweighted:
K-FACTORS:
EQUIVALENT ENVELOPE DELAY:

VIDEO INPUT LEVEL:
HARMONIC RADIATION:

AURAL PERFORMANCE

POWER OUTPUT:⁶
LOAD IMPEDANCE:
AUDIO INPUT LEVEL:
FREQUENCY DEVIATION CAPABILITY:
INPUT IMPEDANCE:
PRE-EMPHASIS:
FREQUENCY RESPONSE:
DISTORTION:⁷
FM NOISE:
INTERCARRIER PHASE MODULATION (noise):⁷
AM NOISE:
SYNCHRONOUS AM NOISE:⁸
FREQUENCY STABILITY:⁹

SERVICE CONDITIONS

AMBIENT TEMPERATURE:¹⁰
AMBIENT HUMIDITY RANGE:
ALTITUDE:
PHYSICAL AND MECHANICAL DIMENSIONS:

ELECTRICAL REQUIREMENTS:

System M/NTSC

(Systems B/PAL and B/SECAM specifications available on request.)

35 kW peak.
 50 ohms. Output connectors: 3/8" EIA standard.
 174-216 MHz (Channels 7-13).
 ±250 Hz (maximum variation over 30 days).
 ±2 Hz with optional precise frequency control.

3% or less relative to sync peak.
 Less than 2%.
 -3.58 MHz -42 dB or better
 -1.25 MHz and lower -26 dB or better
 -0.75 MHz to +4.10 MHz ±0.5 dB
 +4.18 MHz +0.5, -1 dB
 +4.75 MHz and higher -30 dB or better
 ±0.75 dB.

0%.
 3% or better.
 ±3° or better relative to blanking.
 1.0 dB or better.
 ±1° or better.

-55 dB RMS or better relative to sync peak.
 2T 2%, 20T less than 5% baseline disturbance.
 0.2 to 2.1 MHz ±40 ns
 at 3.58 MHz ±25 ns
 at 4.18 MHz ±60 ns
 (referenced to FCC standard curve)
 75 ohm, -30 dB or better return loss up to 5.5 MHz.
 -80 dB relative to peak of sync.

4.5 kW.
 50 ohms. Output connector: 3/8" EIA standard, unflanged.
 +10 dBm, ±2 dB.
 ±50 kHz.
 600 ohms, balanced.
 75 microseconds.
 ±0.5 dB rel. to pre-emphasis curve, (30-15,000 Hz).
 0.5% THD or less with ±25 kHz deviation from 30-15,000 Hz.
 -60 dB RMS or better rel. to ±25 kHz dev.
 -46 dB RMS or better rel. to ±25 kHz dev.
 -55 dB RMS rel. to 100% amplitude modulation of aural carrier.
 -40 dB RMS or better.
 ±20 Hz (maximum variation over 30 days).

0° to +50° C (32° to 122° F).
 0 to 95% relative humidity.
 Sea level to 7,500 feet.
 Trans.: 106" W x 32.2" D x 72" H. Weight:
 2,385 lbs. Power supply:
 69.9" W x 33.9" D x 54" H. Weight: 3,000 lbs.
 Power input: 208/240 volts, ±11 volts,
 3 phase, 60 Hz. Power consumption (typical): 78 kW, black picture, 10% aural;
 66 kW, average picture (50% APL), 10% aural; power factor better than 0.97.

SPECIFICATIONS SUBJECT TO CHANGE WITHOUT NOTICE.

¹ After initial aging of 60 days.
² Response specified for transmitter operating into a resistive load of 1.05 VSWR or better.
³ Measured using 20% p.p. amplitude swept video modulation with pedestal set at black 10%, white 90% with reference to grey level 50%. All percentages relative to blanking to white excursion.
⁴ Measured with 5-step riser signal from 75% to 12.5% of sync peak. Sub-carrier mod. percentage 12.5% peak to peak.
⁵ Measured with a 5-step riser signal. Test signal No. 3 CCIR REC 421-3.
⁶ Capable of additional 0.5 dB power output above rated output to compensate for diplexer loss.
⁷ After de-emphasis.
⁸ Rel. to 100% amplitude modulation at rated deviation.
⁹ Relative to frequency offset of 4.5 MHz from the visual carrier, after initial aging of 60 days.
¹⁰ Derate 2° C per 1000 feet (305 meters) altitude above sea level.

ORDERING INFORMATION

TV-35H, 35 kW VHF-TV transmitter for System M service, Channels 7-13, complete with operating tubes, semiconductors, crystals, required pre-correction circuitry, low-level vestigial sideband filter, harmonic and color notch filters, 208/240 volts, 60 Hz 994-8498-001
TVD-70H, 70 kW dual VHF-TV transmitter for System M service, Channels 7-13, complete with operating tubes, semiconductors, crystals, required pre-correction circuitry, low-level vestigial sideband filter, harmonic and color notch filter, output combiner, input and output switchers, 208/240 volts, 60 Hz 994-8667-001



HARRIS

TV-25H

**25-Kilowatt VHF
High Band
Color Television
Transmitter**

- Advanced Transversal SideBand (TSB) filter—requires no group delay correction, no tuning adjustments
- Solid-state exciters and IPA
- Superior color performance—minimal corrections required
- Fast turn-on time
- Automatic power control is a standard feature
- IF Modulation of the visual and aural carriers
- Solid-state control circuits
- Easily interfaced with ATS and remote control systems
- Compact design, with excellent accessibility
- Pre-wired cabinets for fast and easy installation

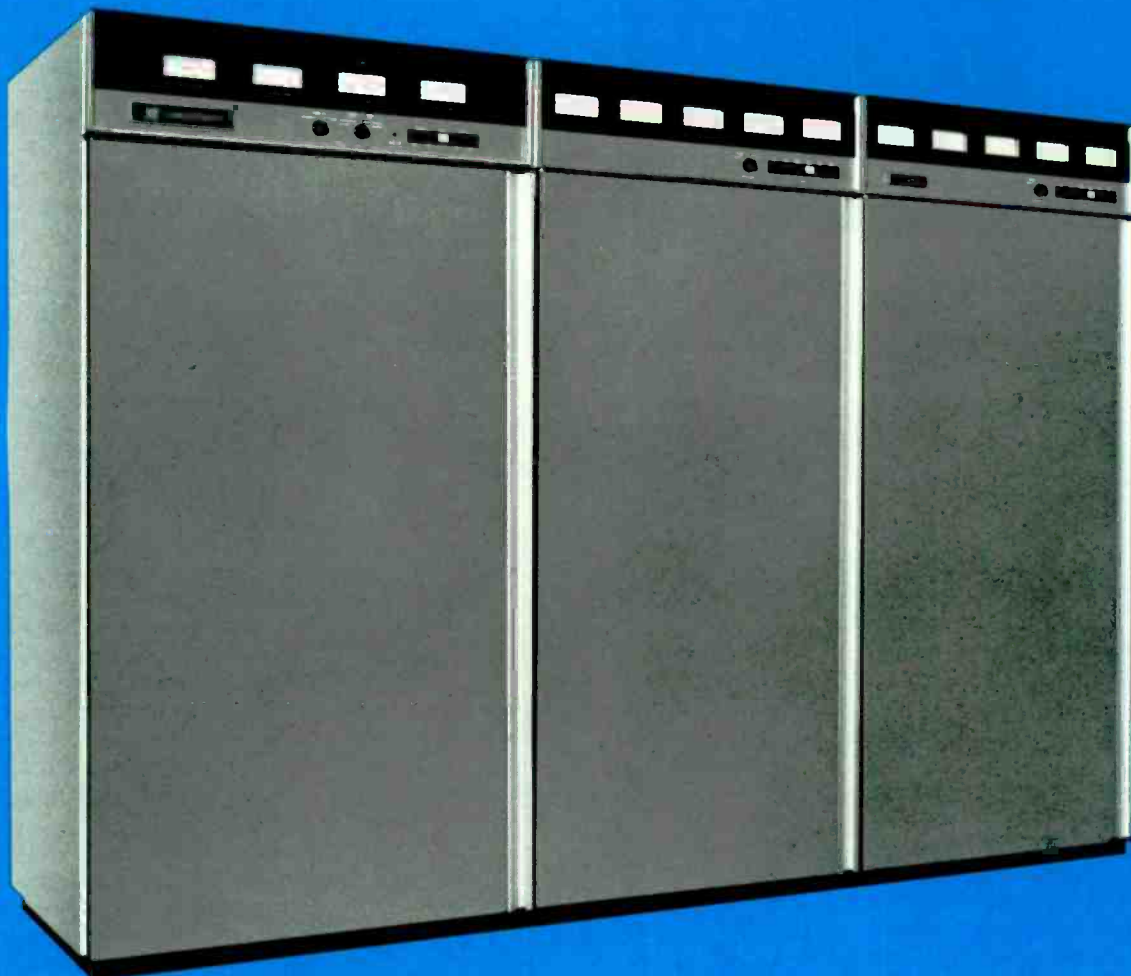

TV-25H

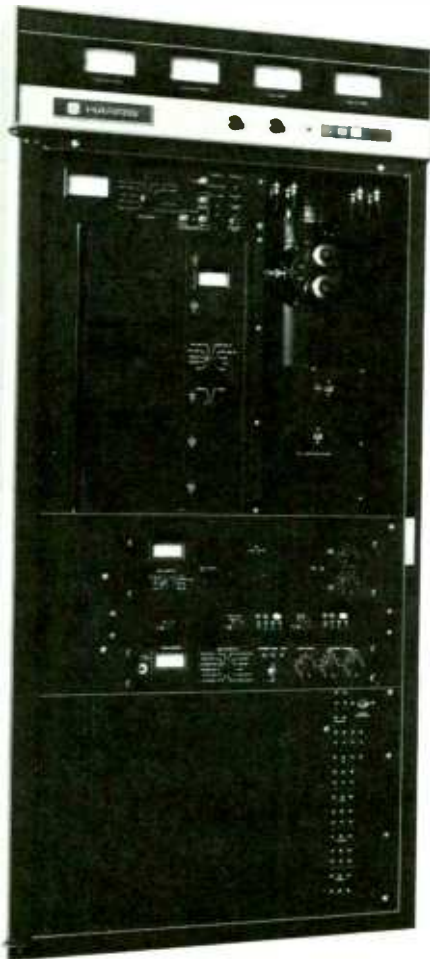

Ultra-linear driver cabinet with solid-state IPA

The Harris TV-25H features a solid-state IPA to greatly enhance reliability and reduce tuning requirements, with a compact cabinet configuration.

This advanced high-band VHF-TV transmitter requires only one aural and two visual tubes to provide a 25-kilowatt visual and a 5-kilowatt aural output. Under normal operating conditions the quick-heat tubes permit transmitter turn-on within 20 seconds. A circulator between the visual stages minimizes retuning requirements after a tube change.

Surface acoustic wave technology is applied to vestigial sideband filtering in the visual exciter. The Transversal SideBand (TSB) filter displays a near-ideal bandpass function for CCIR Systems "M" (FCC) and "B" bandwidths. This, combined with the filter's true linear phase characteristic, offers excellent reproduction of pulse

waveforms and encoded color information without adjustment.

The solid-state IPA contains broadband amplifiers, so that periodic bandpass adjustment is not required—and it is fully protected against damage caused by overloads or load variations. For added transmitter protection, RF drive is applied over a one to two second interval, which permits DC voltage stabilization before full RF drive application to power amplifiers. The IPA is fully metered for monitoring and maintenance, while excellent cooling helps maintain long transistor life.

SUPERB COLOR PERFORMANCE

In addition to the solid-state IPA and the TSB filter, Harris' TV-25H incorporates such

state-of-the-art features as IF (intermediate frequency) Modulation, true linear operation of power amplifiers, and solid-state visual and aural exciter/modulators, to provide the finest color performance and sound fidelity available today. As no envelope delay correction or adjustments are required for the sideband filter, stability, reliability and color quality are greatly enhanced. Frequency adjustment, power output control and amplifier tuning are straightforward and uncomplicated, while design simplicity and conservatively rated components assure long-term "hands-off" operation and minimum maintenance.

The transmitter employs a single-ended visual PA (8916 tetrode), and DC filaments in every stage for an excellent signal-to-noise ratio.

TRANSVERSAL SIDEBAND (TSB) FILTER

The Harris solid-state sideband filter is an advanced surface acoustic wave design, and shapes visual sidebands at the IF frequency, rather than "on frequency" at the full output power of the transmitter. Unlike previous VSB filters, the TSB filter has an inherent linear phase characteristic and requires no group delay correction or tuning.

Additionally, the TSB filter has steep skirts and high attenuation outside the channel passband for excellent VSB wave shaping.

Only 1½ square inches in size, the TSB filter is mounted on a PC board in the visual exciter.

SOLID-STATE VISUAL AND AURAL EXCITER/MODULATORS

The Harris solid-state MCP-1V visual exciter/modulator is an independent, self-contained unit which provides a fully processed on-channel picture signal. Power output can be varied up to one watt with a single front panel control, or from a remote location, without retuning of any kind.

The exciter is mounted in a pull-out drawer and may be operated outside the main transmitter for test purposes. A switch and meter mounted on the front panel permit monitoring exciter parameters. Power and video gain controls are motor driven with manual override provision to permit both local and remote adjustment.

TV-25H

The MCP-1V provides great reliability and stability, excellent frequency response, and truest color quality. It is designed for minimum maintenance and set-up time, and for remote control and unattended operation. This is all made possible through the use of the latest design techniques, including Harris' solid-state TSB filter.

The Harris aural exciter/modulator is a solid-state, self-contained unit which furnishes a fully processed aural signal at a level up to 10 watts. Power output can be set with a single knob on the front panel, or by remote control, with no need for retuning. It is mounted in a pull-out drawer, and may be operated with the drawer extended for test purposes.

INTERMEDIATE FREQUENCY (IF) MODULATION

One of the important features of the TV-25H is its true low-level IF Modulation, which offers a top quality picture, and excels in electrical performance, reliability and simplicity of operation.

In the TV-25H the visual and aural exciters generate fully modulated low-level IF signals. The output of a common crystal controlled reference oscillator is used to raise the individual IF signal to the desired "on channel" output frequency.

Due to the low-level techniques, which include the use of devices such as an extremely linear broadband diode ring modulator, low-level sideband filtering and very linear broadband amplifiers, the color signal is a faithful reproduction of the signal applied to the transmitter input.

SOLID-STATE CONTROL CIRCUITS

Solid-state memory, timing and logic circuits offer complete and foolproof control of all transmitter functions. Built-in memory circuitry enables the entire transmitter to return to the air automatically in the state it was operating prior to an AC power interruption.

The control logic, in addition to commanding normal AC control functions, is also used to visually indicate, through indicator lights, the operating status of the transmitter system. These indicator lights allow isolation of circuit faults, and are easily removed.

REMOTE CONTROL, UNATTENDED AND AUTOMATIC OPERATION

All control, metering and monitoring circuits have been designed specifically for remote control and ATS. The power controls are motor driven and the necessary remote control sampling points are built-in on accessible terminal boards. Today, Harris TV transmitters are being successfully operated worldwide with a variety of remote control systems.

AUTOMATIC POWER CONTROL

Automatic gain control of all RF amplifier stages, in conjunction with the exciters' automatic power control, insures essentially constant power output, even with variations in line voltages. This feature is standard in the TV-25H.

STABILITY

One factor assuring RF stability is the use of a solid-state IPA and conservatively rated Type 8988 and 8916 ceramic tetrodes operating as VHF linear amplifiers. These amplifier stages operate in a common grid and screen configuration and tube neutralization is not required.

EXCELLENT COOLING SYSTEM

The cooling system of the TV-25H is quiet and efficient, and employs direct drive blowers, with the motors fully protected by automatic reset devices.

POWER SUPPLIES

The HV power supply for the visual and aural PAs exhibits very low ripple content. It is designed for excellent regulation and low video impedance for optimum picture performance. In addition, for ease of maintenance, this power supply, including transformer and solid-state rectifiers, is housed in a single assembly, mounted externally from the transmitter. Routine maintenance access is provided by a removable panel.

Vacuum tube filaments in the visual and aural transmitters are operated from DC power supplies to maximize the output signal-to-noise ratio. Grid and screen supplies are 100% solid state.

The visual and aural exciters have their own independent, solid-state regulated power supplies.

EASE OF MAINTENANCE

Convenient access to components is provided, permitting the transmitter to be easily maintained. Visual and aural exciters slide out and can operate independently from the transmitter outside the cabinet. Various exciter circuits, such as oscillators, modulators and processing circuitry, are of modular construction and can be removed for maintenance or replacement.

Easy-to-read, eye-level 4-inch meters are used to monitor required transmitter functions. Meter panels are of double-hinged construction for easy access during maintenance.

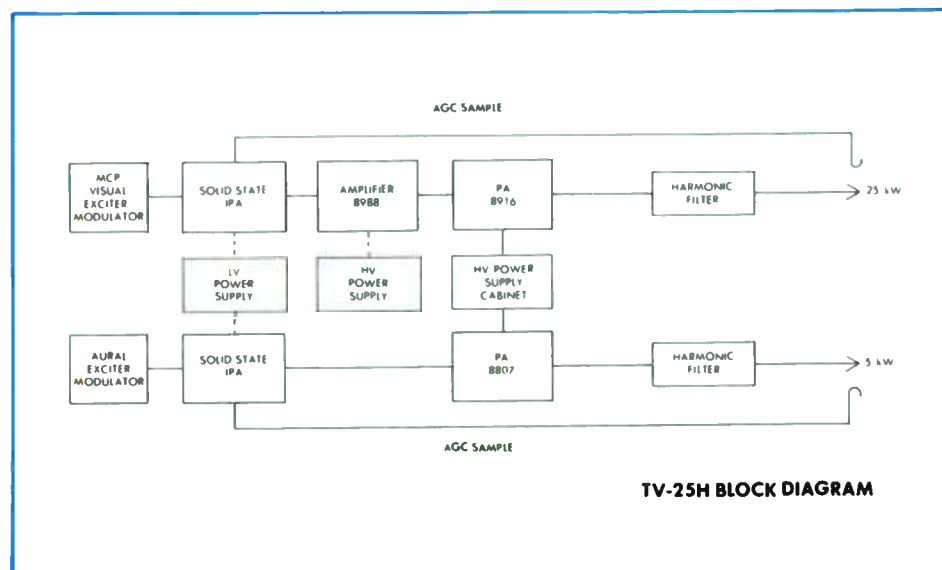

TV-25H BLOCK DIAGRAM

TV-25H SPECIFICATIONS

VISUAL PERFORMANCE

POWER OUTPUT:
OUTPUT IMPEDANCE:
FREQUENCY RANGE:
CARRIER STABILITY:¹
REG. OF RF OUTPUT POWER (Black to white pic.):
VARIATION OF OUTPUT (over one frame):
VISUAL SIDEBAND RESPONSE:

FCC (System "M")
 25 kW peak.
 50 ohms. Output connectors: 3/8" EIA standard.
 174-216 MHz (Channels 7-13).
 ±250 Hz (maximum variation over 30 days).
 3% or less.
 Less than 2%.
 -3.58 MHz -42 dB or better
 -1.25 MHz and lower -26 dB or better
 Carrier to -0.75 MHz ±0.5 dB
 Carrier 0 dB reference
 Carrier to +4.20 MHz ±0.5 dB
 +4.75 MHz and higher -30 dB or better

CCIR (System "B")

21 kW peak.
 50 ohms. Output connector: 3/8" EIA standard.
 174-230 MHz (Band III).
 ±250 Hz (Maximum variation over 30 days).
 3% or less.
 Less than 2%.
 -4.43 MHz -30 dB or better
 -1.25 MHz -26 dB or better
 -0.75 MHz +0.5, -3 dB
 -0.50 MHz +0.5, -1 dB
 Carrier +0.5, -0.5 dB
 +1.5 MHz Reference
 +3.0 MHz ±0.5 dB
 +4.43 MHz +0.5, -1 dB
 +5.0 MHz +0.5, -2.5 dB
 +5.5 MHz -26 dB or better

FREQUENCY RESPONSE VS. BRIGHTNESS:²
VISUAL MODULATION CAPABILITY:
DIFFERENTIAL GAIN:³
INCIDENTAL PHASE MODULATION:
LINEARITY (LOW FREQUENCY):

±0.75 dB.
 1% or better.
 3% or better.
 ±3° or better.
 1.0 dB or better.

DIFFERENTIAL PHASE:⁴
SIGNAL-TO-NOISE RATIO:
K-FACTORS:
EQUIVALENT ENVELOPE DELAY:

±1° or better.
 -55 dB or better (RMS) below sync level.
 2± 2%, 12.5± less than 5% baseline disturbance.
 .05 to 2.1 MHz: ± 40 ns.
 at 3.58 MHz: ± 30 ns.
 at 4.18 MHz: ± 60 ns.
 (referenced to standard curve—FCC).
 75 ohm system.
 -80 dB.
 (Not applicable).
 (Not applicable).

VIDEO INPUT:⁵
HARMONIC RADIATION:
INTERCARRIER PHASE MODULATION (noise):
HIGH FREQUENCY TRANSIENT RESPONSE,
 15 kHz and 250 kHz:

±0.75 dB.
 1% or better.
 3% or better.
 ±3° or better.
 Amplitude dev. ⁵min/⁵ max better than 0.85 mod.
 with signal No. 3 CCIR, from 10% to 85% in
 frequency range 1 to 5 MHz.
 ±1° or better.
 -40 dB below black to white transition.
 2± 2%, 20± 3% or better.
 up to 4.5 MHz: ±50 ns.
 from 4.5 MHz to 4.8 MHz: ±100 ns.
 (measured with Nyquist demodulator meeting ARD
 specifications.)
 75 ohm system.
 -80 dB.
 -40 dB or better with ref. to ±50 kHz dev.
 ±75 ns -10% ±200 ns +7%
 ±100 ns +11% ±400-1000 ns ±5%
 400-1000 ns ±3% for LF variation.

AURAL PERFORMANCE

POWER OUTPUT:
OUTPUT IMPEDANCE:
AUDIO INPUT:
FREQUENCY DEVIATION:
INPUT IMPEDANCE:
PRE-EMPHASIS:
FREQUENCY RESPONSE:
DISTORTION:

5 kW at diplexer output.
 50 ohms. Output connector: 3/8" EIA Std.
 +10 dBm, ±2 dB.
 ±25 kHz.
 600 ohms.
 75 microseconds.
 ±0.5 dB rel. to pre-emphasis (30-15,000 Hz).
 0.5% or less after 75 microseconds de-emphasis
 with ±25 kHz deviation.

Up to 5 kW at diplexer output.
 50 ohms. Output connector: 3/8" EIA Std.
 +10 dBm, ±2 dB.
 ±50 kHz.
 600 ohms.
 50 microseconds ±5 microseconds.
 ±0.5 dB rel. to pre-emphasis (30-15,000 Hz).
 Less than 1% from 30 to 15,000 Hz with ±50 kHz
 dev. (Less than twice measured amount at 70 kHz
 deviation).
 -60 dB or better rel. to ±50 kHz dev.
 -55 dB relative to 100% modulation.
 -40 dB or better
 ±250 Hz

FM NOISE:
AM NOISE:⁶
SYNCHRONOUS AM NOISE:⁷
FREQUENCY STABILITY:⁸

-60 dB or better rel. to ±25 kHz dev.
 -55 dB relative to 100% modulation.
 (Not applicable).
 ±250 Hz.

SERVICE CONDITIONS

AMBIENT TEMPERATURE:
AMBIENT HUMIDITY RANGE:
ALTITUDE:
PHYSICAL AND MECHANICAL DIMENSIONS:

-10° to +50°C (14° to 122°F).
 0 to 95% relative humidity.
 Sea level to 7500 ft.
 97 3/4" W x 31 5/8" D x 72" H. Weight: 3235 lbs. Power
 supply: 36" W x 24" D x 60.4" H. Weight: 950 lbs.

-10° to +50°C.
 0 to 95% relative humidity
 Sea level to 2286 meters.
 247 1 cm W x 80 cm D x 183 cm H. Weight 1,470 Kg.
 Power supply: 91.5 cm W x 61 cm D x 153.4 cm H.
 Weight: 432 Kg.

ELECTRICAL REQUIREMENTS:

Power input: 208/240 volts, ±11 volts, 3 phase,
 50/60 Hz. Power consumption (approx.): 58 kVA,
 black picture, 10% aural; 49 kVA, average pic-
 ture (50% APL), 10% aural; 62 kVA, black pic-
 ture at 20% aural; 53 kVA, average picture at
 20% aural.

Power input: 380/415 volts, 3 phase, 50/60 Hz. Power
 consumption (approx.): 58 kVA, black picture,
 10% aural; 49 kVA, average picture (50% APL),
 10% aural; 62 kVA, black picture at 20% aural;
 53 kVA, average picture at 20% aural.

SPECIFICATIONS SUBJECT TO CHANGE WITHOUT NOTICE.

- ¹ After initial aging of 60 days.
- ² Measured at 65% and 15% of modulation. Reference 100% = peak of sync.
- ³ Maximum variation of sub-carrier amplitude from 75% to 10% of mod. Sub-carrier mod. percentage: 10% peak to peak.
- ⁴ Maximum variation of sub-carrier phase with respect to burst for mod. percentage from 75% to 10%. Sub-carrier mod. percentage: 10% peak to peak.
- ⁵ Bridging, loop through input with -30 dB or better return loss up to 5.5 MHz.
- ⁶ After de-emphasis.
- ⁷ Rel. to 100% AM modulation at ±50 kHz deviation.
- ⁸ Relative to frequency offset by 4.5 MHz (FCC), 5.5 MHz (CCIR) from the visual carrier.

ORDERING INFORMATION

TV-25H, 25 kW VHF-TV transmitter for FCC standards service, Channels 7-13, with operating tubes, transistors, ICs, solid-state rectifiers, crystals, required pre-correction circuitry, low-level vestigial sideband filter, harmonic and color notch filters 994-8405-001

TV-25H 21 kW VHF-TV transmitter for CCIR System "B" service, 174-230 MHz (Band III), 380/415 volts, 50/60 Hz, equipped as above 994-8405-003



HARRIS

TV-18H

**18-Kilowatt VHF
High Band
Color Television
Transmitter**

- Advanced Transversal SideBand (TSB) filter—requires no group delay correction, no tuning adjustments
- Solid-state exciters and IPA for enhanced reliability
- Superior color performance—minimal corrections required
- Fast turn-on time
- Automatic power control is a standard feature
- IF Modulation of the visual and aural carriers
- Solid-state control circuits
- Easily interfaced with ATS and remote control systems
- Compact design, with excellent accessibility
- Pre-wired cabinets for fast and easy installation

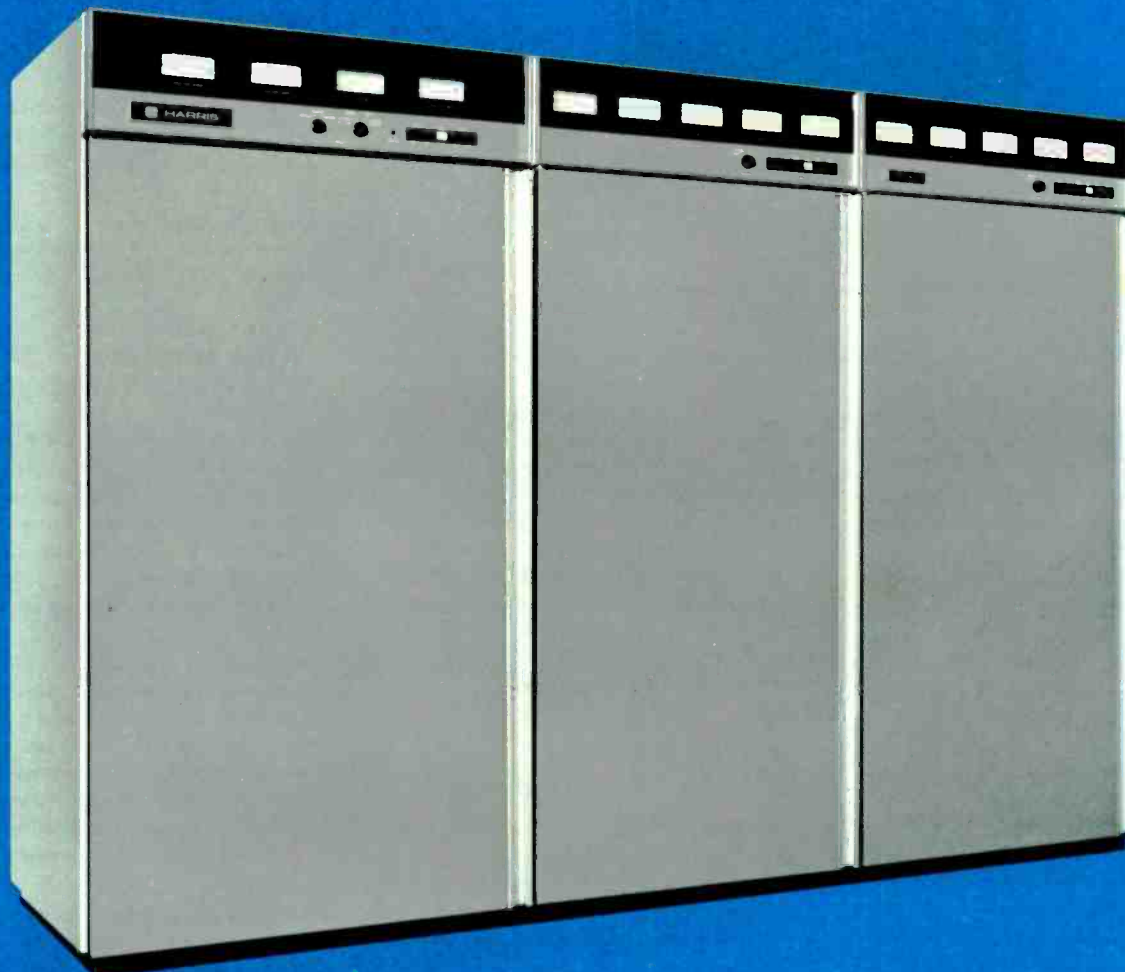

TV-18H



Ultra-linear driver cabinet with solid-state IPA

The Harris TV-18H features a solid-state IPA to greatly enhance reliability and reduce tuning requirements, with a compact cabinet configuration.

This advanced high-band VHF-TV transmitter requires only one aural and two visual tubes to provide an 18-kilowatt visual and a 3.6-kilowatt aural output. Under normal operating conditions, the quick-heat tubes permit transmitter turn-on within 20 seconds. A circulator between the visual stages minimizes retuning requirements after a tube change.

Surface acoustic wave technology is applied to vestigial sideband filtering in the visual exciter. The Transversal SideBand (TSB) filter displays a near-ideal bandpass function for CCIR Systems "M" (FCC) and "B" bandwidths. This, combined with the filter's true linear phase characteristic, offers excellent reproduction of pulse waveforms and encoded color information without adjustment.

The solid-state IPA contains broadband amplifiers, so that periodic bandpass adjustment is not required—and it is fully protected against damage caused by overloads or load variations. For added transmitter protection at turn on, RF drive is brought up to operating level over a one to two second interval, which permits DC voltage stabilization before full RF drive application to power amplifiers. The IPA is fully metered for monitoring and maintenance, while excellent cooling helps maintain long transistor life.

SUPERB COLOR PERFORMANCE

In addition to the solid-state IPA and the TSB filter, Harris' TV-18H incorporates such state-of-the-art features as IF (intermediate frequency) Modulation, true linear operation of power amplifiers, and solid-state visual and aural exciter/modulators, to

provide the finest color performance and sound fidelity available today. As no envelope delay correction or adjustments are required for the sideband filter, stability, reliability and color quality are greatly enhanced. Frequency adjustment, power output control and amplifier tuning are straightforward and uncomplicated, while design simplicity and conservatively rated components assure long-term "hands-off" operation and minimum maintenance.

The transmitter employs a single-ended visual PA (8916 tetrode), and DC filaments in every stage for an excellent signal-to-noise ratio.

TRANSVERSAL SIDEBAND (TSB) FILTER

The Harris solid-state sideband filter is an advanced surface acoustic wave design, and shapes visual sidebands at the IF frequency, rather than "on frequency" at the full output power of the transmitter. Unlike previous VSB filters, the TSB filter has an inherent linear phase characteristic and requires no group delay correction or tuning.

Additionally, the TSB filter has steep skirts and high attenuation outside the channel passband for excellent VSB wave shaping.

Only 1½ square inches in size, the TSB filter is mounted on a PC board in the visual exciter.

SOLID-STATE VISUAL AND AURAL EXCITER/MODULATORS

The Harris solid-state MCP-1V visual exciter/modulator is an independent, self-contained unit which provides a fully processed on-channel picture signal. Power output can be varied up to one watt with a single front panel control, or from a remote location, without retuning of any kind.

The exciter is mounted in a pull-out drawer and may be operated outside the main transmitter for test purposes. A switch and meter mounted on the front panel permit monitoring exciter parameters. Power and video gain controls are motor driven with manual override provision to permit both local and remote adjustment.

The MCP-1V provides great reliability and stability, excellent frequency response, and truest color quality. It is designed for minimum maintenance and set-up time, and for remote control and unattended

TV-18H

operation. This is all made possible through the use of the latest design techniques, including Harris' solid-state TSB filter.

The Harris aural exciter/modulator is a solid-state, self-contained unit which furnishes a fully processed aural signal at a level up to 10 watts. Power output can be set with a single knob on the front panel, or by remote control, with no need for retuning. It is mounted in a pull-out drawer, and may be operated with the drawer extended for test purposes.

INTERMEDIATE FREQUENCY (IF) MODULATION

One of the important features of the TV-18H is its true low-level IF Modulation, which offers a top quality picture, and excels in electrical performance, reliability and simplicity of operation.

In the TV-18H the visual and aural exciters generate fully modulated low-level IF signals. The output of a common crystal controlled reference oscillator is used to raise the individual IF signal to the desired "on channel" output frequency.

Due to the low-level techniques, which include the use of devices such as an extremely linear broadband diode ring modulator, low-level sideband filtering and very linear broadband amplifiers, the color signal is a faithful reproduction of the signal applied to the transmitter input.

SOLID-STATE CONTROL CIRCUITS

Solid-state memory, timing and logic circuits offer complete and foolproof control of all transmitter functions. Built-in memory circuitry enables the entire transmitter to return to the air automatically in the state it was operating prior to an AC power interruption.

The control logic, in addition to commanding normal AC control functions, is also used to visually indicate, through indicator lights, the operating status of the transmitter system. These indicator lights allow isolation of circuit faults, and are easily removed.

REMOTE CONTROL, UNATTENDED AND AUTOMATIC OPERATION

All control, metering and monitoring circuits have been designed specifically for remote control and ATS. The power con-

trols are motor driven and the necessary remote control sampling points are built-in on accessible terminal boards. Today, Harris TV transmitters are being successfully operated worldwide with a variety of remote control systems.

AUTOMATIC POWER CONTROL

Automatic gain control of all RF amplifier stages, in conjunction with the exciters' automatic power control, insures essentially constant power output, even with variations in line voltages. This feature is standard in the TV-18H.

STABILITY

One factor assuring RF stability is the use of a solid-state IPA and conservatively rated Type 8988, 8807 and 8916 ceramic tetrodes operating as VHF linear amplifiers. These amplifier stages operate in a common grid and screen configuration and tube neutralization is not required.

EXCELLENT COOLING SYSTEM

The cooling system of the TV-18H is quiet and efficient, and employs direct drive blowers, with the motors fully protected by automatic reset devices.

POWER SUPPLIES

The HV power supply for the visual and

aural PAs exhibits very low ripple content. It is designed for excellent regulation and low video impedance for optimum picture performance. In addition, for ease of maintenance, this power supply, including transformer and solid-state rectifiers, is housed in a single assembly, mounted externally from the transmitter. Routine maintenance access is provided by a removable panel.

Vacuum tube filaments in the visual and aural transmitters are operated from DC power supplies to maximize the output signal-to-noise ratio. Grid and screen supplies are 100% solid state.

The visual and aural exciters have their own independent, solid-state regulated power supplies.

EASE OF MAINTENANCE

Convenient access to components is provided, permitting the transmitter to be easily maintained. Visual and aural exciters slide out and can operate independently from the transmitter outside the cabinet. Various exciter circuits, such as oscillators, modulators and processing circuitry, are of modular construction and can be removed for maintenance or replacement.

Easy-to-read, eye-level 4-inch meters are used to monitor required transmitter functions. Meter panels are of double-hinged construction for easy access during maintenance.

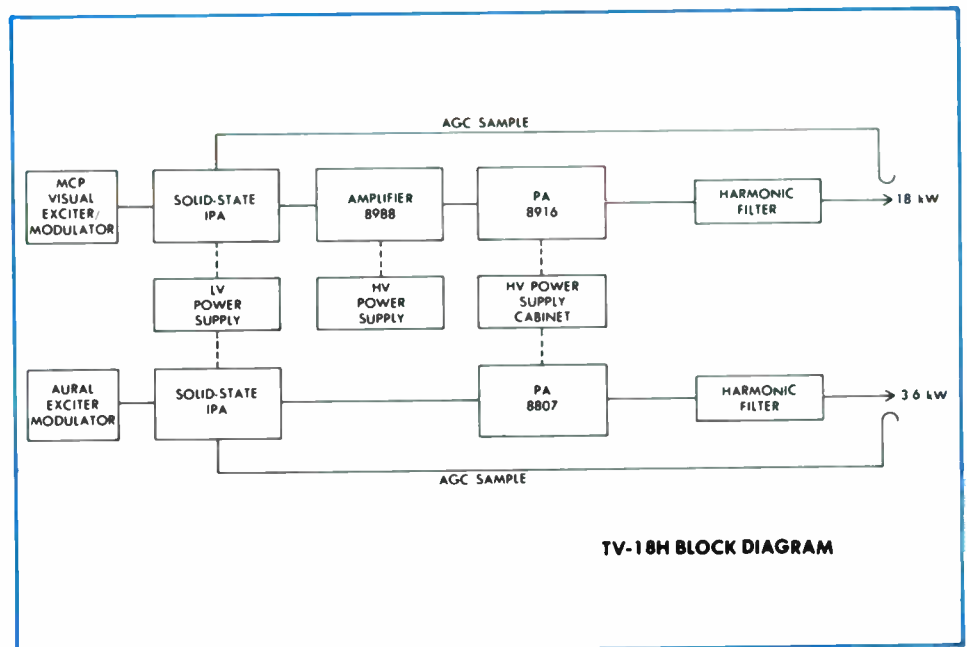

TV-18H SPECIFICATIONS

VISUAL PERFORMANCE

POWER OUTPUT:
OUTPUT IMPEDANCE:
FREQUENCY RANGE:
CARRIER STABILITY:¹
REG. OF RF OUTPUT POWER (Black to white pic.):
VARIATION OF OUTPUT (over one frame):
VISUAL SIDEBAND RESPONSE:

FCC (System "M")

18 kW peak.
 50 ohms. Output connector: 3/8" EIA standard.
 174-216 MHz (Channels 7-13).
 ±250 Hz (maximum variation over 30 days).
 3% or less.
 Less than 2%.
 —3.58 MHz —42 dB or better
 —1.25 MHz and lower —26 dB or better
 Carrier to —0.75 MHz ±0.5 dB
 Carrier 0 dB reference
 Carrier to +4.20 MHz ±0.5 dB
 +4.75 MHz and higher —30 dB or better

CCIR (System "B")

18 kW peak.
 50 ohms. Output connector: 3/8" EIA standard.
 174-230 MHz (Band III).
 ±250 Hz (maximum variation over 30 days).
 3% or less.
 Less than 2%.
 —4.43 MHz —30 dB or better
 —1.25 MHz —26 dB or better
 —0.75 MHz +0.5, —3 dB
 —0.50 MHz +0.5, —1 dB
 Carrier +0.5, —0.5 dB
 +1.5 MHz Reference
 +3.0 MHz ±0.5 dB
 +4.43 MHz +0.5, —1 dB
 +5.0 MHz +0.5, —2.5 dB
 +5.5 MHz —26 dB or better
 ±0.75 dB.

FREQUENCY RESPONSE VS. BRIGHTNESS:²

VISUAL MODULATION CAPABILITY:

DIFFERENTIAL GAIN:³

INCIDENTAL PHASE MODULATION:

LINEARITY (LOW FREQUENCY):

±0.75 dB.
 1% or better.
 3% or better.
 ±3° or better.
 1.0 dB or better.

±0.75 dB.
 1% or better.
 3% or better.

±3°

Amplitude dev. ⁵min/⁵ max better than 0.85 mod with signal No. 3 CCIR, from 10% to 85% in frequency range 1 to 5 MHz.

DIFFERENTIAL PHASE:⁴

SIGNAL-TO-NOISE RATIO:

K-FACTORS:

EQUIVALENT ENVELOPE DELAY:

±1° or better.
 —55 dB or better (RMS) below sync level.
 2± 2%, 12.5± less than 5% baseline disturbance.
 .05 to 2.1 MHz: ± 40 ns.
 at 3.58 MHz: ± 30 ns.
 at 4.18 MHz: ± 60 ns.
 (referenced to standard curve—FCC).

±1° or better.

—50 dB or better (RMS) below sync level.

2± 2%, 20± 3% or better.

up to 4.5 MHz: ±50 ns.

from 4.5 MHz to 4.8 MHz: ±100 ns.

(measured with Nyquist demodulator meeting ARD specifications.)

VIDEO INPUT:⁵

HARMONIC RADIATION:

INTERCARRIER PHASE MODULATION (noise):

HIGH FREQUENCY TRANSIENT RESPONSE,

15 kHz and 250 kHz:

75 ohm system.
 —80 dB.
 (Not applicable).
 (Not applicable).

75 ohm system.

—80 dB.

—40 dB or better with ref. to ±50 kHz dev.

±75 ns —10% ±200 ns +7%

±100 ns + 11% ±400-1000 ns ±5%

400-1000 ns ±3% for LF variation.

AURAL PERFORMANCE

POWER OUTPUT:

OUTPUT IMPEDANCE:

AUDIO INPUT:

FREQUENCY DEVIATION:

INPUT IMPEDANCE:

PRE-EMPHASIS:

FREQUENCY RESPONSE:

DISTORTION:

3.6 kW at diplexer output.
 50 ohms. Output connector: 3/8" EIA Std.
 +10 dBm, ±2 dB.
 ±25 kHz.
 600 ohms.
 75 microseconds.
 ±0.5 dB rel. to pre-emphasis (30-15,000 Hz).
 0.5% or less after 75 microseconds de-emphasis with ±25 kHz deviation.

Up to 3.6 kW at diplexer output.

50 ohms. Output connector: 3/8" EIA Std.

+10 dBm, ±2 dB.

±50 kHz.

600 ohms.

50 microseconds ±5 microseconds.

±0.5 dB rel. to pre-emphasis (30-15,000 Hz).

Less than 1% from 30 to 15,000 Hz with ±50 kHz dev. (Less than twice measured amount at 70 kHz deviation).

FM NOISE:

AM NOISE:⁶

SYNCHRONOUS AM NOISE:⁷

FREQUENCY STABILITY:⁸

—60 dB or better rel. to ±25 kHz dev.
 —55 dB relative to 100% modulation.
 (Not applicable).
 ±250 Hz.

—60 dB or better rel. to ±50 kHz dev.

—55 dB relative to 100% modulation.

—40 dB or better.

±250 Hz.

SERVICE CONDITIONS

AMBIENT TEMPERATURE:

AMBIENT HUMIDITY RANGE:

ALTITUDE:

PHYSICAL AND MECHANICAL DIMENSIONS:

—10° to +50°C (14° to 122°F).

0 to 95% relative humidity.

Sea level to 7500 ft.

97.3" W x 31.5" D x 72" H. Weight: 3235 lbs. Power supply: 36" W x 24" D x 60.4" H. Weight: 950 lbs.

—10° to +50°C.

0 to 95% relative humidity.

Sea level to 2286 meters.

247.1 cm W x 80 cm D x 183 cm H. Weight 1,470 Kg.

Power supply: 91.5 cm W x 61 cm D x 153.4 cm H.

Weight: 432 Kg.

ELECTRICAL REQUIREMENTS:

Power input: 208/240 volts, ±11 volts, 3 phase, 50/60 Hz. Power consumption (approx.): 55 kVA, black picture, 10% aural; 46.8 kVA, average picture (50% APL), 10% aural; 59 kVA, black picture at 20% aural; 50.2 kVA, average picture at 20% aural.

Power input: 380/415 volts, 3 phase, 50/60 Hz. Power consumption (approx.): 63.8 kVA, black picture, 10% aural; 54.3 kVA, average picture (50% APL), 10% aural; 68.4 kVA, black picture at 20% aural; 58.2 kVA, average picture at 20% aural.

SPECIFICATIONS SUBJECT TO CHANGE WITHOUT NOTICE.

¹ After initial aging of 60 days.

² Measured at 65% and 15% of modulation. Reference 100%=peak of sync.

³ Maximum variation of sub-carrier amplitude from 75% to 10% of mod. Sub-carrier mod. percentage: 10% peak to peak.

⁴ Maximum variation of sub-carrier phase with respect to burst for mod. percentage from 75% to 10%. Sub-carrier mod. percentage: 10% peak to peak.

⁵ Bridging, loop through input with —30 dB or better return loss up to 5.5 MHz.

⁶ After de-emphasis.

⁷ Rel. to 100% AM modulation at ±50 kHz deviation.

⁸ Relative to frequency offset by 4.5 MHz (FCC), 5.5 (CCIR) from the visual carrier.

ORDERING INFORMATION

TV-18H, 18 kW VHF-TV transmitter for FCC standards service, Channels 7-13, with operating tubes, transistors, ICs, solid-state rectifiers, crystals, required pre-correction circuitry, low-level vestigial sideband filter, harmonic and color notch filters 994-8497-001

TV-18H 18 kW VHF-TV transmitter for CCIR System "B" service, 174-230 MHz (Band III), 380/415 volts, 50/60 Hz, equipped as above 994-8497-003



HARRIS

TV-10H

10-Kilowatt CCIR Band III Color Television Transmitter

The Harris TV-10H, ten-kilowatt CCIR Band III color TV transmitter, is designed specifically for use in CCIR Systems "B" and "M"—with many features of particular interest to international broadcasters.

The solid-state IPA/three-tube design greatly enhances reliability, reduces tuning requirements and allows an unusually compact cabinet configuration.

Surface acoustic wave technology is applied to vestigial sideband filtering in the visual exciter, so that the Transversal SideBand (TSB) filter displays a near-ideal bandpass function for CCIR Systems "B" and "M" bandwidths. This, combined with the filter's true linear phase characteristic, offers excellent pulse and color transmissions without adjustment.

The solid-state IPA contains broadband amplifiers, so no tuning is

required—and it is fully protected against damage caused by overloads or load variations. Gradual (1 to 2 seconds) RF turn-on permits DC voltage stabilization before RF drive application to power amplifiers, for added transmitter protection. The IPA is fully metered for monitoring and maintenance, while excellent cooling helps maintain long transistor life.

SUPERB PERFORMANCE

In addition to the solid-state IPA and the TSB filter, Harris' TV-10H incorporates such state-of-the-art features as IF (intermediate frequency) Modulation, true linear operation of power amplifiers, and solid-state visual and aural exciter/modulators, to provide the finest color performance and sound fidelity available today. As no envelope delay correction or adjustments are required for the sideband filter, stability, reliability and color quality are greatly enhanced. Frequency adjustment, power output control and amplifier tuning are straightforward and uncomplicated, while design simplicity and conservatively rated components assure long-term "hands-off" operation and minimum maintenance.

The transmitter employs a single-ended visual PA (8807 tetrode) for low power consumption, and DC filaments in the visual stage for improved signal-to-noise ratio.

TRANSVERSAL SIDE BAND (TSB) FILTER

The Harris solid-state sideband filter is an advanced surface acoustic wave design, and shapes visual sidebands at the IF frequency, rather than "on frequency" at the full output power of the transmitter. Unlike previous VSB filters, which require from 600 to 1000 nsec of group delay correction, and many adjustments, the TSB filter has an inherent linear phase characteristic and requires no group delay correction. Other VSB filters need 6 to 12 tuning controls, while the Harris TSB filter needs no tuning controls, as it requires no tuning adjustments—ever!

Additionally, the TSB filter has steeper skirts and higher attenuation outside the channel passband for improved VSB wave shaping.

Only 1½ square inches in size, the TSB filter is mounted on a PC board in the visual exciter.

SOLID-STATE VISUAL AND AURAL EXCITER/MODULATORS

The Harris solid-state MCP-1V visual

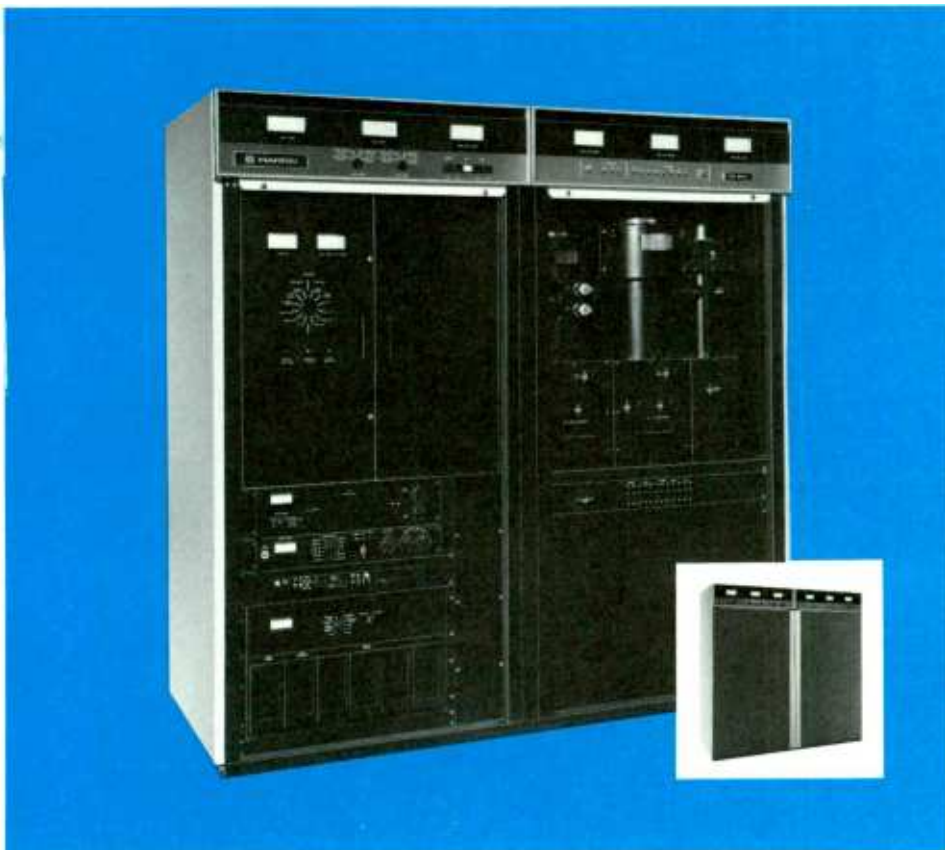

exciter/modulator is an independent, self-contained unit which provides a fully processed on-channel picture signal. Power output can be varied up to one watt with a single front panel control, or from a remote location, without retuning of any kind.

The exciter is mounted in a pull-out drawer and may be operated outside the main transmitter for test purposes. A switch and meter mounted on the front panel permit monitoring exciter parameters. Power and video gain controls are motor driven with manual override provision.

The MCP-1V provides great reliability and stability, excellent frequency response, and truest color quality. It is also designed for minimum maintenance and set-up time, and for remote control and unattended operation. This is all made possible through the use of the latest design techniques, including Harris' solid-state TSB filter.

The Harris aural exciter/modulator is a solid-state self-contained unit which furnishes a fully processed aural signal at a level up to 10 watts. Power output can be set with a single knob on the front panel, or by remote control, with no need for retuning. It is mounted in a pull-out drawer, and may be operated with the drawer extended for test purposes.

INTERMEDIATE FREQUENCY (IF) MODULATION

One of the features of the TV-10H is its true low-level IF Modulation, which offers a top quality picture, and excels in electrical performance, reliability and simplicity of operation.

In the TV-10H the visual and aural exciters generate fully modulated low-level IF signals. The output of a common crystal controlled reference oscillator is used to raise the individual IF signal to the desired "on channel" output frequency.

Due to the low-level techniques, which include the use of devices such as an extremely linear broadband diode ring modulator, low-level sideband filtering and very linear broadband amplifiers, the broadcast signal is a faithful reproduction of the signal applied to the transmitter input.

SOLID-STATE CONTROL CIRCUITS

Solid-state memory, timing and logic circuits—employing CMOS IC's for design simplicity and enhanced reliability—offer complete and foolproof control of all transmitter functions. Built-in memory circuitry enables the entire transmitter to return to the air automatically in the stage it was operating prior to a partial or full power failure. The memory is con-

tinuous, and is maintained without an emergency power source during power failures.

The control logic and protective circuitry, in addition to commanding normal AC control functions, is also used to visually indicate, through indicator lights, the operating status of the transmitter system. These indicator lights allow isolation of circuit faults, and are easily removed.

REMOTE CONTROL, UNATTENDED AND AUTOMATIC OPERATION

All control, metering and monitoring circuits have been designed specifically for remote control and unattended operation. The power controls are motor driven and the necessary remote control sampling points are built-in on accessible terminal boards.

Today, Harris TV transmitters are being operated successfully worldwide in an unattended mode, with and without remote control access. In addition, Harris' transmitter design is consistent with anticipated automatic transmitter needs in the future.

AUTOMATIC POWER CONTROL

Automatic gain control of all RF amplifier stages, in conjunction with the exciters' automatic power control, insures essentially constant power output, even with variations in line voltages. This feature is standard in the TV-10H.

STABILITY

One factor assuring RF stability is the use of a solid-state IPA and conservatively rated Type 8988 and 8807 ceramic tetrodes operating as VHF linear amplifiers. These amplifier stages operate in a common grid and screen configuration

and tube neutralization is not required.

EXCELLENT COOLING SYSTEM

The cooling system of the TV-10H is quiet and efficient, and employs a direct drive blower, with the motor fully protected by automatic reset devices. Tube manufacturers' recommendations are met or exceeded at altitudes up to 3000 meters, enhancing tube life without power derating.

POWER SUPPLIES

The HV power supply is a 3-phase choke input supply, exhibiting very low ripple content. It is designed for excellent regulation and low video impedance for optimum picture performance. This power supply, including transformer and solid-state rectifiers, is housed in a single assembly, mounted externally from the transmitter. Routine maintenance access is provided by a removable panel.

Vacuum tube filaments in the visual transmitter are operated from DC power supplies to maximize the output signal-to-noise ratio. Grid and screen supplies use solid-state regulators.

The visual and aural exciters have their own independent, solid-state regulated power supplies.

EASE OF MAINTENANCE

Visual and aural exciters slide out and can operate independently from the transmitter outside the cabinet. Various exciter circuits, such as oscillators, modulators and processing circuitry, are of modular construction and can be removed for maintenance or replacement.

Easy-to-read, eye-level 4-inch meters are used to monitor required transmitter functions. Meter panels are of double-hinged construction for convenient access during maintenance.

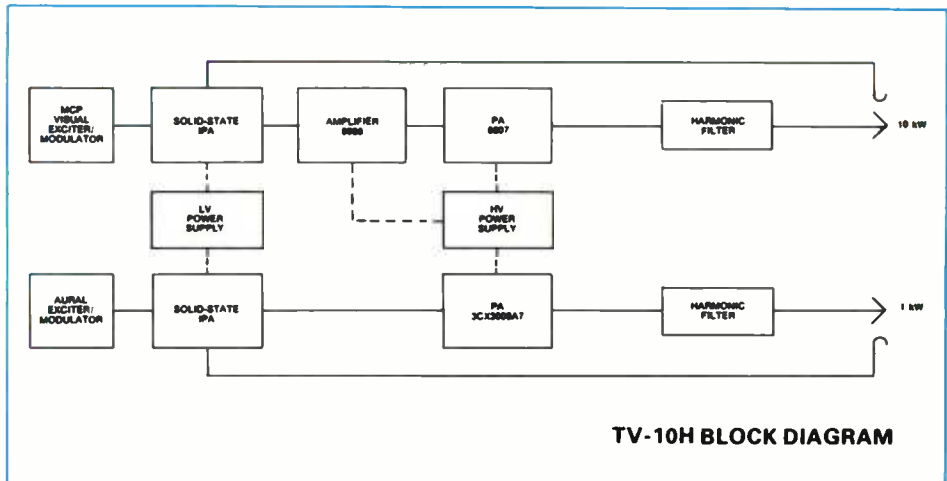

TV-10H BLOCK DIAGRAM

TV-10H SPECIFICATIONS

CCIR System M, 525 Lines, 60 Hz (FCC Type)

VISUAL PERFORMANCE

POWER OUTPUT:	13 kW peak.
OUTPUT IMPEDANCE:	50 ohms. Output connector: 3/8" EIA standard. (FCC Channels 7-13).
FREQUENCY RANGE:	174-216 MHz.
CARRIER STABILITY: ¹	±250 Hz (maximum variation over 30 days).
REG. OF RF OUTPUT POWER (Black to white pic.):	3% or less.
VARIATION OF OUTPUT (over one frame):	Less than 2%.
VISUAL SIDEBAND RESPONSE:	-3.58 MHz -42 dB or better -1.25 MHz and lower -26 dB or better Carrier to -0.75 MHz ±0.5 dB Carrier 0 dB reference Carrier to +4.20 MHz ±0.5 dB +4.75 MHz and higher -30 dB or better
FREQUENCY RESPONSE VS. BRIGHTNESS: ²	±0.75 dB.
VISUAL MODULATION CAPABILITY:	0%.
DIFFERENTIAL GAIN: ³	3% or better.
LINEARITY (LOW FREQUENCY):	10% or better.
DIFFERENTIAL PHASE: ⁴	±1° or better.
SIGNAL-TO-NOISE RATIO:	-55 dB or better (RMS) below sync level.
2t K FACTOR:	2% maximum.
12.5t GAIN & DELAY RESPONSE:	5% Total Baseline disturbance.
EQUIVALENT ENVELOPE DELAY:	.05 to 2.1 MHz: ±40 ns at 3.58 MHz: ±30 ns at 4.18 MHz: ±60 ns (referenced to standard curve—FCC)
VIDEO INPUT: ⁵	75 ohm system.
HARMONIC RADIATION:	-80 dB.
INCIDENTAL PHASE MODULATION:	±3° or less relative to blanking.

AURAL PERFORMANCE

POWER OUTPUT: ⁸	1.3 kW at diplexer output.
OUTPUT IMPEDANCE:	50 ohms. Output connector: Type N bulkhead.
AUDIO INPUT:	+10 dBm, ±2 dB.
FREQUENCY DEVIATION:	±25 kHz.
INPUT IMPEDANCE:	600 ohms.
PRE-EMPHASIS:	75 microseconds.
FREQUENCY RESPONSE:	±0.5 dB rel. to pre-emphasis (30-15,000 Hz).
DISTORTION:	0.5% or less after 75 microseconds de-emphasis with ±25 kHz deviation.
FM NOISE: ⁶	-60 dB or better rel. to ±25 kHz dev.
AM NOISE:	-55 dB relative to 100% modulation of the aural carrier.
INTERCARRIER PHASE MODULATION: ⁶	-46 dB or better relative to ±25 kHz deviation.
FREQUENCY STABILITY: ⁷	±20 Hz.
ELECTRICAL REQUIREMENTS:	Power input: 208/240 Volts, ±11 Volts, 3 phase, 60 Hz. Typical power consumption: 30 kVA, black picture; 27 kVA, average picture. Power factor: .97 typical.

SERVICE CONDITIONS

AMBIENT TEMPERATURE:	-10° to +50° C (14° to 122° F).
AMBIENT HUMIDITY RANGE:	0 to 95% relative humidity.
ALTITUDE:	Sea level to 10,000 feet (3048 meters).
PHYSICAL AND MECHANICAL DIMENSIONS:	Transmitter cabinet: 71 in. W × 32.3 in. D × 71.7 in. H. (180 cm × 82 cm × 182 cm). Weight: 1,874 lbs. (850 kg). Power supply: 48 in. W × 24 in. D × 60.7 in. H. (122 cm × 61 cm × 153 cm). Weight: 1,477 lbs. (670 kg).

SPECIFICATIONS SUBJECT TO CHANGE WITHOUT NOTICE

¹After initial aging of 60 days.

²Pedestal set to 50 IRE Units carrier plus 200 kHz set to 0 dB reference. Sweep amplitude set to 20 IRE units peak to peak. Pedestal varied from 20 to 80 IRE units.

³Maximum variation of sub-carrier amplitude from 75% to 10% of mod. Sub-carrier mod. percentage: 10% peak to peak.

⁴Maximum variation of sub-carrier phase with respect to burst for mod. percentage from 75% to 10%. Sub-carrier mod. percentage: 10% peak to peak.

⁵Bridging, loop through input with -30 dB or better return loss up to 5.5 MHz.

⁶After de-emphasis.

⁷Relative to frequency offset by 4.5 MHz from the visual carrier.

⁸8.2 kW aural available on special order.

ORDERING INFORMATION

TV-10H 10 kW VHF-TV transmitter for CCIR System "M" service, 174-216 MHz 208/240 volts, 60 Hz, with operating tubes, transistors, IC's, solid-state rectifiers, crystals, required pre-correction circuitry, low level sideband filter, harmonic filters, color notch filter 994-8224-003

TV-10H SPECIFICATIONS

CCIR System B, 625 Lines, 50 Hz

VISUAL PERFORMANCE

POWER OUTPUT:	10 kW.
COLOR SYSTEM:	PAL, SECAM.
TYPE MODULATION:	A5C negative.
FREQUENCY RANGE:	174-230 MHz, Band III, Channels E5-E12.
VIDEO INPUT IMPEDANCE: ¹	75 ohms.
VIDEO INPUT LEVEL:	.7 to 2.0 volts, peak to peak, sync. negative.
RF OUTPUT:	50 ohms. Output connector: 3/8" EIA, flanged with unflanged adapter.
AM NOISE: ²	
HUM AND LOW FREQUENCY:	
PERIODIC NOISE 10 kHz to 5.2 MHz:	-60 dB or better peak to peak.
TOTAL RANDOM AND PERIODIC NOISE UNWEIGHED:	-40 dB peak to peak.
MODULATION CAPABILITY:	
RF POWER OUTPUT VARIATION:	-55 dB RMS or better.
FREQUENCY RESPONSE VARIATION: ³	0%, sync equal to 100%.
LUMINANCE NONLINEARITY: ⁴	Less than 2% total variation for pedestal levels 10% to 75% of sync.
VISUAL SIDEBAND RESPONSE:	Less than ±0.75 dB.
	10% or better.
	-4.43 MHz -30 dB
	-1.25 MHz -22 dB
	-0.75 MHz to 5.5 MHz ±0.5 dB
	+5.5 MHz -22 dB
DIFFERENTIAL GAIN: ⁴	3% or better.
DIFFERENTIAL PHASE: ⁴	±1° or better.
2t K FACTOR:	2% maximum.
20t GAIN & DELAY RESPONSE:	5% or less total baseline disturbance.
CHROMANANCE INTERMODULATION: ⁵	Less than 2% total distortion.
BLANKING VARIATION:	Less than 2% total variation.
FIELD FREQUENCY SQUARE WAVE TILT:	Less than 2% total variation.
INCIDENTAL PHASE MODULATION:	±3° or less relative to blanking.
EQUIVALENT ENVELOPE DELAY:	Complies with system requirements.
CARRIER STABILITY:	±250 Hz (maximum variation over 30 days).
HARMONIC RADIATION:	-80 dB or better below sync peak.

AURAL PERFORMANCE

TYPE OF EMISSION:	FM.
POWER OUTPUT: ⁸	1 kW at diplexer output.
CARRIER STABILITY:	±250 Hz (for 30 days relative to frequency offset from 5.5 MHz visual carrier).
RF OUTPUT IMPEDANCE:	50 ohms output connector: Type N bulkhead.
AUDIO INPUT IMPEDANCE:	600 ohms, balanced.
AUDIO INPUT LEVEL:	0 to +12 dBm.
FREQUENCY DEVIATION:	±50 kHz.
FREQUENCY RESPONSE:	±5 dB relative to 50 microsecond pre-emphasis.
AUDIO DISTORTION:	Less than 1% from 30 to 15,000 Hz with 50 kHz deviation; less than 2% for ±70 kHz deviation.
AM NOISE:	-55 dB or better relative to 100% modulation of the aural carrier.
FM NOISE: ⁶	-60 dB or better relative to ±50 kHz deviation.
SYNCHRONOUS AM NOISE:	Less than 1% relative to 100% AM modulation from 30 to 15,000 Hz with ±50 kHz deviation.
INTERCARRIER NOISE: ⁶	-46 dB or better relative to ±50 kHz deviation.
FREQUENCY STABILITY: ⁷	±20 Hz.
ELECTRICAL REQUIREMENTS:	Power Input: 380/415 volts, ±18 volts, 50 Hz. Typical power consumption; 30 kVA, Black picture; 26 kVA Average picture. Power factor: .97 typical.

SERVICE CONDITIONS

AMBIENT TEMPERATURE:	-10° to +50° C (14° to 122° F).
AMBIENT HUMIDITY RANGE:	0 to 95% relative humidity.
ALTITUDE:	Sea level to 3048 meters (10,000 feet).
PHYSICAL AND MECHANICAL DIMENSIONS:	Transmitter cabinet: 180 cm W × 82 cm D × 182 cm H. (71" × 32.3" × 71.7").
	Weight: 850 kg (1,874 lbs.).
	Power supply: 122 cm W × 61 cm D × 153 cm H. (48" × 24" × 60.7").
	Weight: 670 kg (1,477 lbs.).

SPECIFICATIONS SUBJECT TO CHANGE WITHOUT NOTICE

- ¹Bridging, loop through input with -30 dB or better return loss up to 5.5 MHz.
- ²Noise measured with respect to black to white transition.
- ³Pedestal set to 42% of sync, carrier plus 200 kHz set to 0 dB reference. Sweep amplitude set to 20 IRE units peak to peak. Pedestal varied from 15 to 65%.
- ⁴Measured with a 5 step riser signal. Test signal No. 3 CCIR REC 421-3.
- ⁵Measured with a three level chrominance signal with constant pedestal level.
- ⁶After de-emphasis.
- ⁷Relative to frequency offset by 5.5 MHz from the visual carrier.
- ⁸8.2 kW aural available on special order.

ORDERING INFORMATION

TV-10H 10 kW VHF-TV transmitter for CCIR System "B" service, 174-230 MHz (Band III), 380/415 volts, 50 Hz, with operating tubes, transistors, IC's solid-state rectifiers, crystals, required pre-correction circuitry, low level sidband filter, harmonic filters 994-8224-001



HARRIS

TVD-60L 60-Kilowatt Dual VHF Low Band Color Television Transmitter

- Ultra-linear drivers with solid-state IPAs for maximum reliability and signal transparency
- Two independent, complete 30-kilowatt transmitters for total redundancy and on-the-air reliability
- "Hot" standby exciters, modulators and sideband filter for maximum redundancy
- Harris' Dualtran output switching system allows parallel, single transmitter or alternate/main operation
- Advanced Transversal SideBand (TSB) filters—no group delay, no tuning adjustments required
- IF Modulation of the visual and aural carriers
- Superior color performance, with minimal correction circuitry
- Ideal for circularly polarized applications
- Easily interfaced with ATS and remote control systems

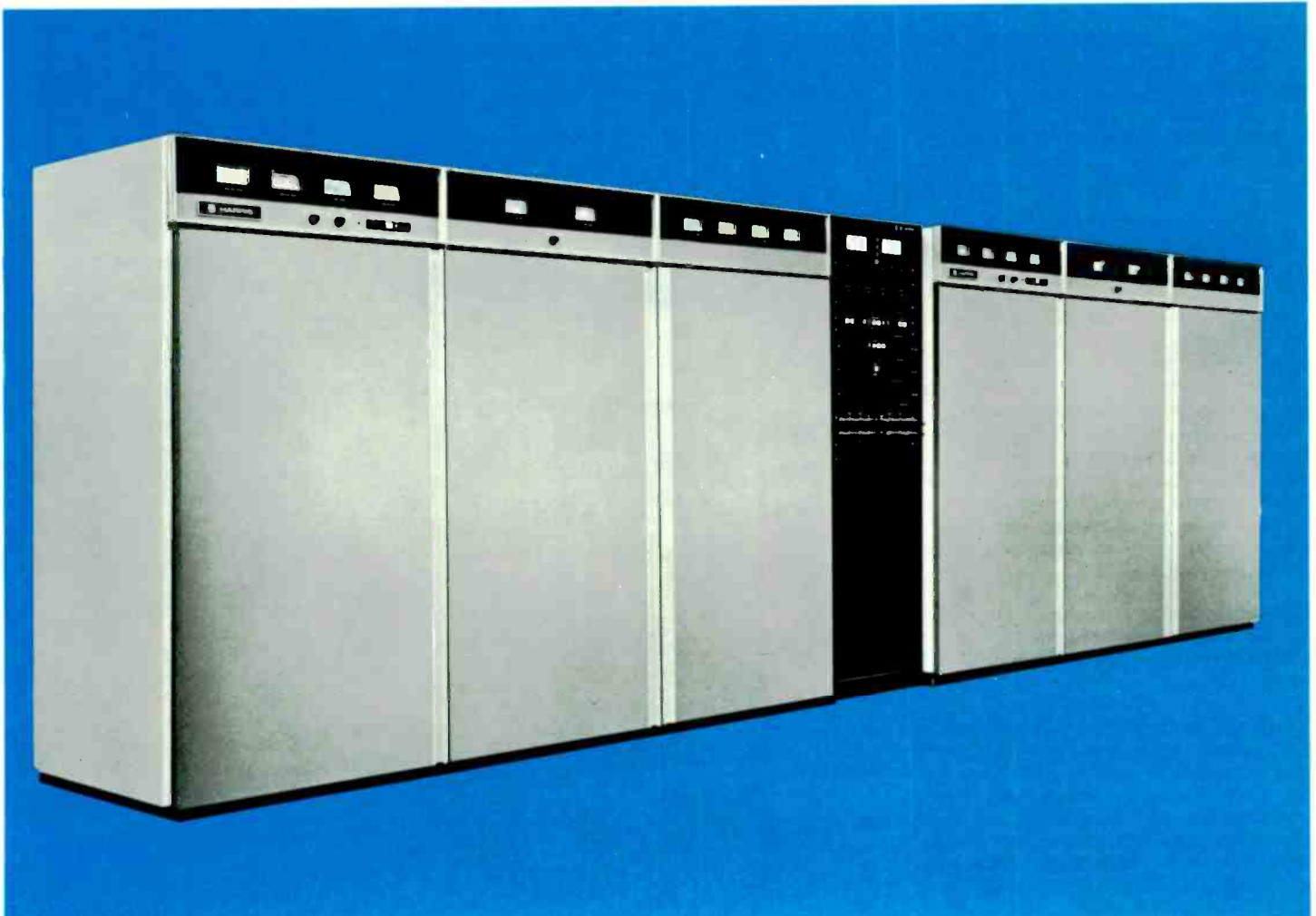

TVD-60L

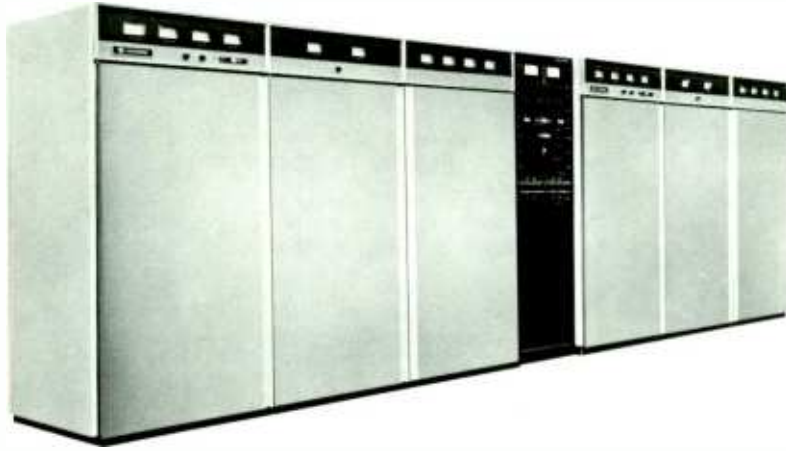

TOTAL REDUNDANCY . . . COMPLETE RELIABILITY

The Harris TVD-60L, 60-kilowatt dual low band VHF TV transmitter, is designed for television broadcasters who want the utmost in reliability and performance—with the flexibility for remote control or automatic operation. Ideal for circularly polarized applications, this powerful dual transmitter incorporates such state-of-the-art features as ultra-linear drivers with solid-state IPAs, and Harris' Transversal SideBand (TSB) filters. The TVD-60L consists of two completely independent 30-kilowatt transmitters operating in parallel, combined through the Harris Dualtran RF switching system.

Each of the two ultra-linear drivers employs a broadband Class A solid-state IPA and a single conservatively-operated tetrode to drive the final visual amplifier. This means maximum linearity and signal transparency without the need for complicated correction circuitry . . . for unmatched reliability and maintainability.

Surface acoustic wave technology is applied to vestigial sideband filtering in the visual exciters. The Harris Transversal SideBand filter displays a near-ideal bandpass function for Systems M (FCC) and B bandwidths. This, combined with the filter's true linear phase characteristic, offers excellent reproduction of pulse waveforms and encoded information.

With the TVD-60L you get two visual exciter/modulators, two aural exciter/modulators, two TSB filters, two solid-state visual and aural IPAs, two visual and aural PAs, and two HV power supplies—in short, total redundancy! Complete reliability!

The Dualtran switching system is factory assembled in one cabinet, and can be supplied to interface with either a hybrid or a notch diplexer.

IF (intermediate frequency) Modulation, low-level sideband filtering, true linear operation of power amplifiers and solid-state visual and aural exciter/modulators combine to provide outstanding color and sound fidelity. As no envelope delay correction or adjustments are required for the solid-state Transversal SideBand filter(s), stability, reliability and color quality are greatly enhanced.

Frequency adjustment, power output control and amplifier tuning are straightforward and uncomplicated, while conservatively rated components in the TVD-60L assure long-term "hands-off" operation.

AUTOMATIC SWITCHING

In the event of a malfunction of one-half of the parallel combination, the Harris TVD-60L offers automatic and instantaneous reduction to one-fourth authorized power. This function will occur without interruption of the carrier. With the touch of a button, half-power operation is achieved in less than two seconds.

Visual and aural exciters are connected in a hot standby condition, and will automatically switch in less than 10 milliseconds in case of failure in either unit. In all modes, aural follows visual for simplified logic control and reliable operation.

OPERATING VERSATILITY

Four modes of operation may be obtained electrically by means of control pushbuttons on the output switcher; by control buttons on the transmitter control panel; or by remote control.

These are:

- Transmitters A and B combined On-Air.
- Transmitter A On-Air and transmitter B into the station loads.
- Transmitter B On-Air and transmitter A into the station loads.
- Transmitters A and B combined to the station loads (test mode).

The switching operation from one mode to any other mode requires less than two seconds.

When using a notch diplexer, three other operating modes may be selected manually by changing links on the Dualtran output switching cabinet: transmitters A and B combined and diplexed to the station load; transmitter A diplexed into the station load; and transmitter B diplexed into the station load.

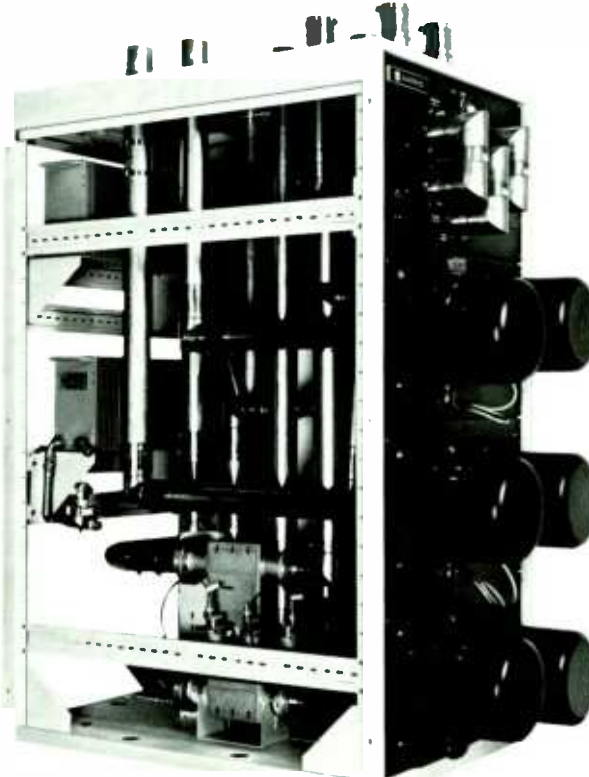

DUALTRAN OUTPUT SWITCHER CABINET

All switches, patch panels, combiners, reject and dummy loads, couplers, sensors and control logic are factory assembled, tested and optimized for best VSWR across the channel. The only external transmission line connections are for the transmitters, antenna and diplexer. This saves installation labor and time, and insures excellent performance without field optimization. Motorized coaxial switches accomplish RF switching at the push of a button on the output switcher control panel, center transmitter control cabinet or via remote control. Solid-state control logic automatically routes command signals to turn off plate voltages, operate proper coaxial switches and re-apply plate voltage . . . all in two seconds or less.

TVD-60L

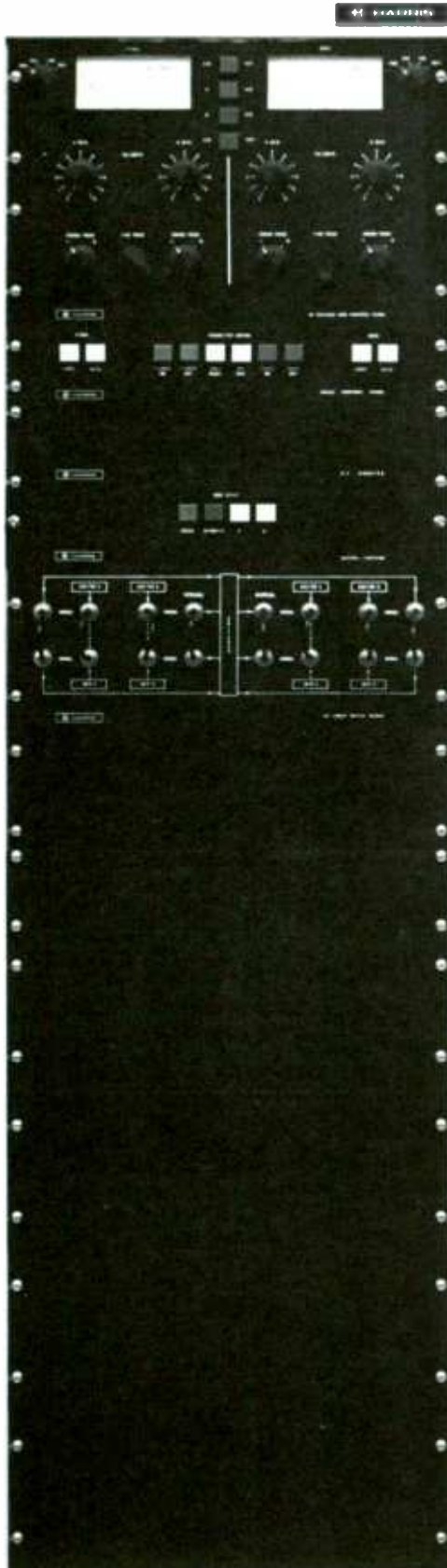

CENTER CONTROL CABINET

All adjustments and control of dual transmitter operation can be accomplished from the control cabinet, supplied as standard equipment in all Harris Dualtran systems. This cabinet is normally mounted between the two independent transmitters to provide a pleasing installation. The RF phasing and control panel, the exciter/modulator switcher, and the local control panel are standard equipment with the Harris Dualtran systems.

RF PHASING AND CONTROL PANEL

Here the output of the on-air exciter/modulator is split to drive the two transmitters. Phasing controls and attenuators provide adjustment of the two signals to assure maximum combined transmitter output. Switchable visual and aural power meters are provided to monitor combined forward, combined reflected and reject power levels. Also, Dualtran output switcher control logic pushbuttons on this panel can select "A + B Air", "A Air", "B Air" or "A + B Test" modes.

LOCAL CONTROL PANEL

Provides simultaneous control of both transmitters including filament and plate on/off and aural and visual raise/lower functions. All system remote control terminals are available on this panel.

EXCITER/MODULATOR SWITCHER

Solid-state control logic provides manual or automatic switching of the two exciter/modulators from "hot standby" to "on-air" status in case of exciter failure. Switching occurs in 10 milliseconds for no perceptible loss of signal.

INPUT PATCH PANEL (Optional)

Permits bypassing the exciter/modulator switcher via BNC cables to patch any combination of aural/visual exciters to any transmitter. This provides extra flexibility for emergency situations and for system maintenance and testing.

RF INPUT BYPASS SWITCHER (Optional—Not Shown)

In single transmitter modes this switcher removes the 3 dB coupler in the RF phasing/control panel from input circuitry, thereby putting full rated power of any one transmitter on the air.

TVD-60L

SOLID-STATE IPAs

The solid-state visual and aural IPAs contain broadband amplifiers, so that periodic bandpass adjustments are not required—and they are fully protected against damage caused by overloads or load variations. For added transmitter protection, RF drive is applied over a one to two second interval, which permits DC voltage stabilization before full RF drive application to power amplifiers. The IPAs are fully metered for monitoring and maintenance, while excellent cooling helps maintain long transistor life.

The two 30-kilowatt transmitters each employ a single-ended visual PA (9007 tetrode) and DC filaments in every visual stage for an excellent signal-to-noise ratio.

TRANSVERSAL SIDEBAND (TSB) FILTER

The Harris solid-state sideband filter is an advanced surface acoustic wave design, and shapes visual sidebands at the IF frequency, rather than "on frequency" at the full output power of the transmitter. Unlike previous VSB filters, the TSB filter has an inherent linear phase characteristic and requires no group delay correction or tuning.

SOLID-STATE VISUAL AND AURAL EXCITER/MODULATORS

The Harris solid-state MCP-1V visual exciter/

modulator is an independent, self-contained unit which provides a fully processed on-channel picture signal. Power output can be varied up to one watt with a single front panel control, or from a remote location, without retuning of any kind.

The MCP-1V provides great reliability and stability, excellent frequency response, and truest color quality. It is designed for minimum maintenance and setup time, and for remote control and unattended operation. This is all made possible through the use of the latest design techniques, including Harris' solid-state TSB filter.

The Harris aural exciter/modulator is a solid-state, self-contained unit which furnishes a fully processed aural signal at a level up to 10 watts. Power output can be set with a single knob on the front panel, or by remote control, with no need for retuning. It is mounted in a pull-out drawer, and may be operated with the drawer extended for test purposes.

INTERMEDIATE FREQUENCY (IF) MODULATION

One of the features of the TVD-60L is its true low-level IF Modulation, which offers a top quality picture, and excels in electrical performance, reliability and simplicity of operation.

Due to the low-level techniques, which include the use of devices such as an extremely linear broadband diode ring modulator, low-level sideband filtering and very linear broadband amplifiers, the color signal is a faithful reproduction of the signal applied to the transmitter input.

SOLID-STATE CONTROL CIRCUITS

Solid-state memory, timing and logic circuits offer complete and foolproof control of all transmitter functions. Built-in memory circuitry enables the entire transmitter to return to the air automatically in the state it was operating prior to an AC power interruption.

The control logic, in addition to commanding normal AC control functions, is also used to visually indicate, through indicator lights, the operating status of the transmitter system. These indicator lights allow easy isolation of circuit faults, and are easily removed.

REMOTE CONTROL, UNATTENDED AND AUTOMATIC OPERATION

All control, metering and monitoring circuits have been designed specifically for remote control and ATS. The power controls are motor driven and the necessary remote con-

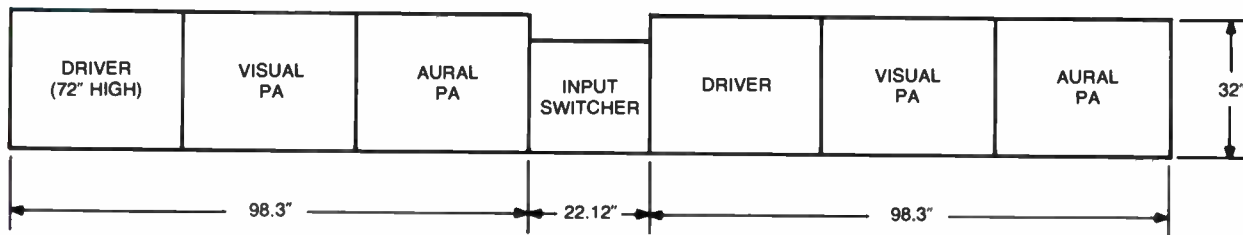
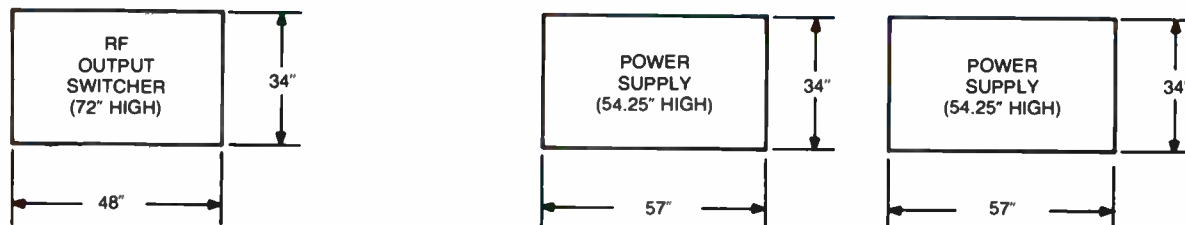

TVD-60L FLOOR PLAN

TVD-60L

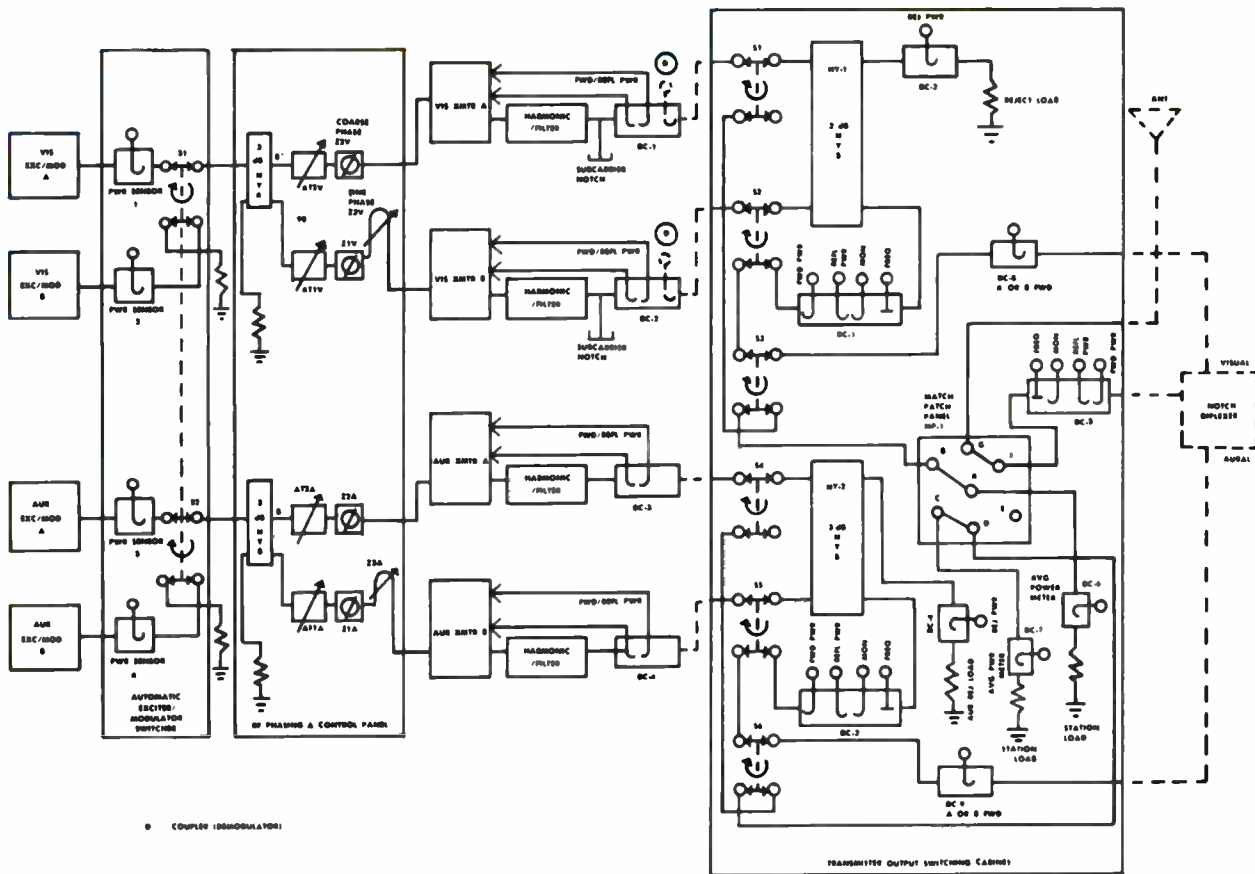

RF FLOW TVD-60L WITH NOTCH DIPLEXER

control sampling points are built-in on accessible terminal boards. Today, Harris TV transmitters are being operated successfully worldwide with a variety of remote control systems, including the versatile, cost-saving Harris 9100 Facilities Control.

AUTOMATIC POWER CONTROL

Automatic gain control of all RF amplifier stages, in conjunction with the exciters' automatic power control, insures essentially constant power output, even with variations in line voltages. This feature is standard in the TVD-60L.

STABILITY

One factor assuring RF stability is the use of solid-state IPAs and conservatively rated Type 8988 and 9007 ceramic tetrodes operating as VHF linear amplifiers. These amplifier stages operate in a common grid and screen configuration and tube neutralization is not required.

EXCELLENT COOLING SYSTEM

The cooling system of the TVD-60L is quiet and efficient, and employs direct drive blowers, with the motors fully protected by automatic reset devices.

POWER SUPPLIES

The HV power supplies for the TVD-60L visual and aural PAs exhibit very low ripple content. They are designed for excellent regulation and low video impedance for optimum picture performance. In addition, for ease of maintenance, the two power supplies, including transformers and solid-state rectifiers, are housed in two separate assemblies, mounted externally from the transmitter. Routine maintenance access is provided by removable panels.

Vacuum tube filaments in the visual transmit-

ters are operated from DC power supplies to maximize the output signal-to-noise ratio. Grid and screen supplies are 100% solid state.

The visual and aural exciters have their own independent, solid-state regulated power supplies.

EASE OF MAINTENANCE

Convenient access to components is provided, permitting the transmitter to be easily maintained. Visual and aural exciters slide out and can operate independently from the transmitter outside the cabinet. Various exciter circuits, such as oscillators, modulators and processing circuitry, are of modular construction and can be removed for maintenance or replacement.

Easy-to-read, eye-level 4-inch meters are used to monitor required transmitter functions. Meter panels are of double-hinged construction for easy access during maintenance.

TVD-60L SPECIFICATIONS

VISUAL PERFORMANCE

POWER OUTPUT:
LOAD IMPEDANCE:
FREQUENCY RANGE:
CARRIER FREQUENCY STABILITY:¹

REG. OF RF OUTPUT POWER (All black to all white pic.):
VARIATION OF OUTPUT (over one frame):
VISUAL SIDEBAND RESPONSE:²

FREQUENCY RESPONSE VS. BRIGHTNESS:³
VISUAL MODULATION CAPABILITY:
DIFFERENTIAL GAIN:⁴
INCIDENTAL PHASE MODULATION:
LINEARITY (LOW FREQUENCY):⁵
DIFFERENTIAL PHASE:⁴
SIGNAL-TO-NOISE:
 Hum and low frequency:⁶
 Periodic noise 10 kHz to 5.2 MHz:⁶
 Total random and periodic noise unweighted:
K-FACTORS:
EQUIVALENT ENVELOPE DELAY:

VIDEO INPUT LEVEL:
HARMONIC RADIATION:

AURAL PERFORMANCE

POWER OUTPUT:⁷
LOAD IMPEDANCE:
AUDIO INPUT LEVEL:
FREQUENCY DEVIATION:
INPUT IMPEDANCE:
PRE-EMPHASIS:
FREQUENCY RESPONSE:
DISTORTION:⁸
FM NOISE:⁹
INTERCARRIER PHASE MODULATION (noise):⁸
AM NOISE:
SYNCHRONOUS AM NOISE:⁹
FREQUENCY STABILITY:¹⁰

SERVICE CONDITIONS

AMBIENT TEMPERATURE:¹¹
AMBIENT HUMIDITY RANGE:
ALTITUDE:
PHYSICAL AND MECHANICAL DIMENSIONS:

ELECTRICAL REQUIREMENTS:

System M/NTSC

60 kW peak.
 50 ohms. Output connectors: 3/8" EIA standard.
 54-88 MHz (Channels 2-6).
 ± 250 Hz (maximum variation over 30 days).
 ± 2 Hz with optional precise frequency control.

3% or less relative to sync peak.

Less than 2%.
 - 3.58 MHz - 42 dB or better
 - 1.25 MHz and lower - 26 dB or better
 - 0.75 MHz to + 4.10 MHz ± 0.5 dB
 + 4.18 MHz + 0.5, - 1 dB
 + 4.75 MHz and higher - 30 dB or better
 ± 0.75 dB.
 0%.
 3% or better.
 ± 3° or better relative to blanking.
 1.0 dB or better.
 ± 1° or better.

- 55 dB or better peak to peak.
 - 40 dB peak to peak.

- 55 dB RMS or better relative to sync peak.
 2T 2%, 20T less than 5% baseline disturbance.
 0.2 to 2.1 MHz ± 40 ns
 at 3.58 MHz ± 25 ns
 at 4.18 MHz ± 60 ns

(referenced to FCC standard curve)
 75 ohm, - 30 dB or better return loss up to 5.5 MHz.
 - 80 dB relative to peak of sync.

12 kW.
 50 ohms. Output connector: 1 1/2" EIA standard, unflanged.
 + 10 dBm, ± 2 dB.
 ± 25 kHz.
 600 ohms, balanced.
 75 microseconds.
 ± 0.5 dB rel. to pre-emphasis curve, (30-15,000 Hz).
 0.5% THD or less with ± 25 kHz deviation from 30-15,000 Hz.
 - 60 dB RMS or better rel. to ± 25 kHz dev.
 - 46 dB RMS or better rel. to ± 25 kHz dev.
 - 55 dB RMS rel. to 100% amplitude modulation of aural carrier.
 - 40 dB RMS or better.
 ± 20 Hz (maximum variation over 30 days).

- 10° to + 50° C (14° to 122° F).

0 to 95% relative humidity.
 Sea level to 7,500 feet.
 Transmitters (2): each 98.3" W x 32" D x 72" H. Weight each: 2,200 lbs. Switcher cabinet (without side panels): 22 1/2" W x 24 5/8" D (with front and rear doors) x 72" H. Weight: 300 lbs. RF Output Switcher: 48" W x 34" D x 72" H. Weight: 1,350 lbs. Power Supplies (2): each 57" W x 34" D x 54.25" H. Weight each: 1,500 lbs.
 Power input: 208/240 volts, ± 11 volts, 3 phase, 50/60 Hz. Power consumption: 132 kW, black picture; 108 kW, average picture.

SPECIFICATIONS SUBJECT TO CHANGE WITHOUT NOTICE.

- ¹ After initial aging of 60 days.
- ² Response specified for transmitter operating into a resistive load of 1.05 VSWR or better.
- ³ Measured using 20% p.p. amplitude swept video modulation with pedestal set at black 10%, white 90% with reference to grey level 50%. All percentages relative to blanking to white excursion.
- ⁴ Measured with 5-step riser signal from 75% to 12.5% of sync peak. Sub-carrier mod. percentage 12.5% peak to peak.
- ⁵ Measured with a 5-step riser signal. Test signal No. 3 CCIR REC 421-3.
- ⁶ Noise measured with respect to a blanking to white transition.
- ⁷ Capable of additional 0.5 dB power output above rated output to compensate for diplexer loss.
- ⁸ After de-emphasis.
- ⁹ Rel. to 100% amplitude modulation at rated deviation.
- ¹⁰ Relative to frequency offset of 4.5 MHz (System M), from the visual carrier, after initial aging of 60 days.
- ¹¹ Derate 2° C per 1000 feet (305 meters) altitude above sea level.

ORDERING INFORMATION

TVD-60L, 60 kW dual VHF-TV transmitter for System M standards service, Channels 2-6, with operating tubes, semiconductors, crystals, VSB filter, harmonic and color notch filters, output combiner, input and output switchers 994-8616-001



HARRIS

TVD-40L 45-Kilowatt Dual VHF Low Band Color Television Transmitter

- Ultra-linear drivers with solid-state IPAs for maximum reliability and signal transparency
- Two independent, complete 22.5-kilowatt transmitters for total redundancy and on-the-air reliability
- "Hot" standby exciters, modulators and sideband filter for maximum redundancy
- Harris' Dualtran output switching system allows parallel, single transmitter or alternate/main operation
- Advanced Transversal SideBand (TSB) filters—no group delay, no tuning adjustments required
- IF Modulation of the visual and aural carriers
- Superior color performance, with minimal correction circuitry
- Ideal for circularly polarized applications
- Easily interfaced with ATS and remote control systems

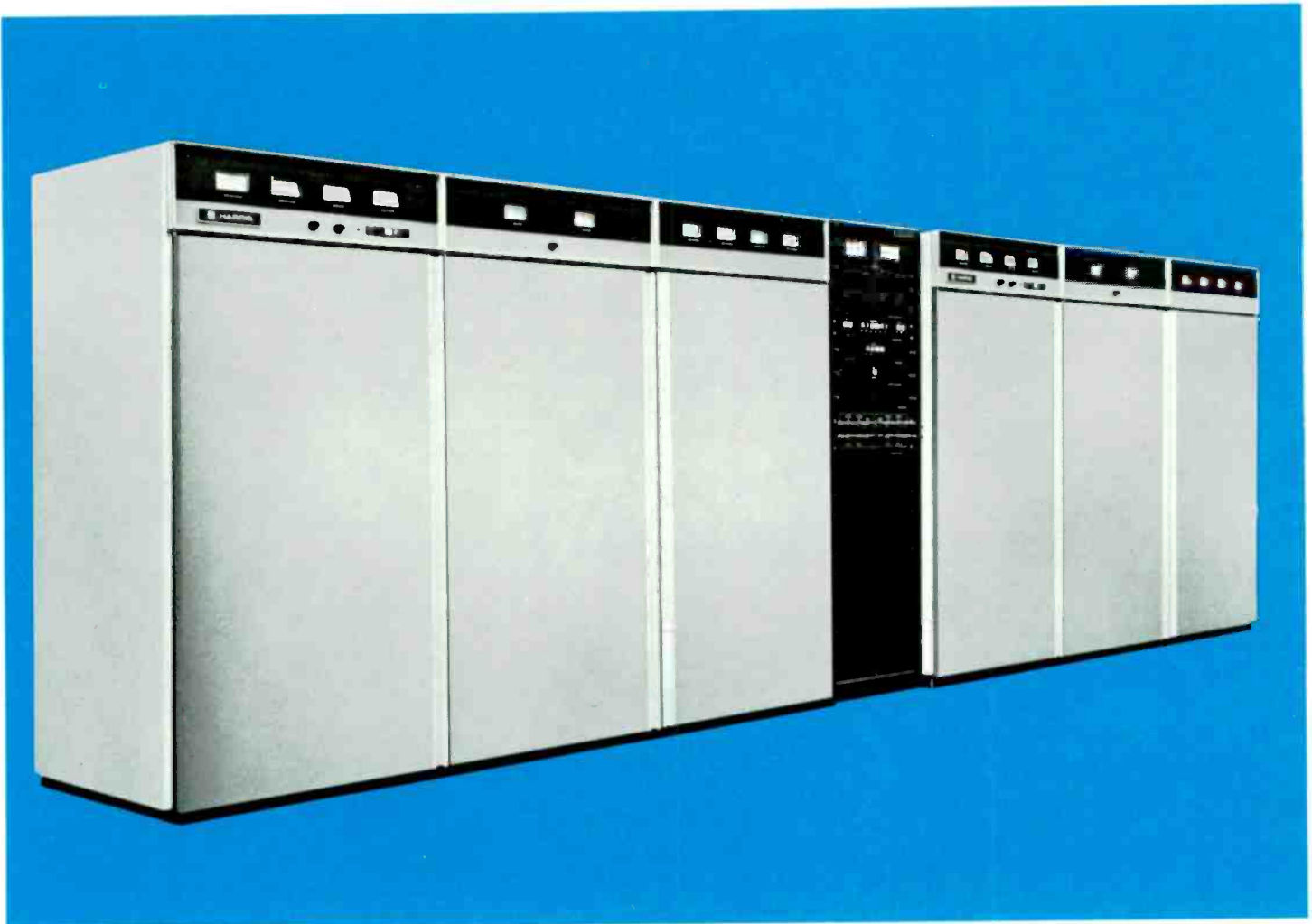



TOTAL REDUNDANCY . . . COMPLETE RELIABILITY

The Harris TVD-40L, 45-kilowatt dual low band VHF TV transmitter, is designed for television broadcasters who want the utmost in reliability and performance—with the flexibility for remote control or automatic operation. Ideal for circularly polarized applications, this powerful dual transmitter incorporates such state-of-the-art features as ultra-linear drivers with solid-state IPAs, and Harris' Transversal SideBand (TSB) filters. The TVD-40L consists of two completely independent 22.5-kilowatt transmitters operating in parallel, combined through the Harris Dualtran RF switching system.

Each of the two ultra-linear drivers employs a broadband Class A solid-state IPA and a single conservatively-operated tetrode to drive the final visual amplifier. This means maximum linearity and signal transparency without the need for complicated correction circuitry . . . for unmatched reliability and maintainability.

Surface acoustic wave technology is applied to vestigial sideband filtering in the visual exciter. The Harris Transversal SideBand filter displays a near-ideal bandpass function for Systems M (FCC) and B bandwidths. This, combined with the filter's true linear phase characteristic, offers excellent reproduction of pulse waveforms and encoded information.

With the TVD-40L you get two visual exciter/modulators, two aural exciter/modulators, two TSB filters, two solid-state visual and aural IPAs, two visual and aural PAs, and two HV power supplies—in short, total redundancy! Complete reliability!

The Dualtran switching system is factory assembled in one cabinet, and can be supplied to interface with either a hybrid or a notch diplexer.

IF (intermediate frequency) Modulation, low-level sideband filtering, true linear operation of power amplifiers and solid-state visual and aural exciter/modulators combine to provide outstanding color and sound fidelity. As no envelope delay correction or adjustments are required for the solid/state Transversal SideBand filter(s), stability, reliability and color quality are greatly enhanced.

Frequency adjustment, power output control and amplifier tuning are straightforward and uncomplicated, while conservatively rated components in the TVD-40L assure long-term "hands-off" operation.

AUTOMATIC SWITCHING

In the event of a malfunction of one-half of the parallel combination, the Harris TVD-40L offers automatic and instantaneous reduction to one-fourth authorized power. This function will occur without interruption of the carrier. With the touch of a button, half-power operation is achieved in less than two seconds.

Visual and aural exciter are connected in a hot standby condition, and will automatically switch in less than 10 milliseconds in case of failure in either unit. In all modes, aural follows visual for simplified logic control and reliable operation.

OPERATING VERSATILITY

Four modes of operation may be obtained electrically by means of control pushbuttons on the output switcher; by control buttons on the transmitter control panel; or by remote control.

These are:

- Transmitters A and B combined On-Air.
- Transmitter A On-Air and transmitter B into the station loads.
- Transmitter B On-Air and transmitter A into the station loads.
- Transmitters A and B combined to the station loads (test mode).

The switching operation from one mode to any other mode requires less than two seconds.

When using a notch diplexer, three other operating modes may be selected manually by changing links on the Dualtran output switching cabinet: transmitters A and B combined and diplexed to the station load; transmitter A diplexed into the station load; and transmitter B diplexed into the station load.

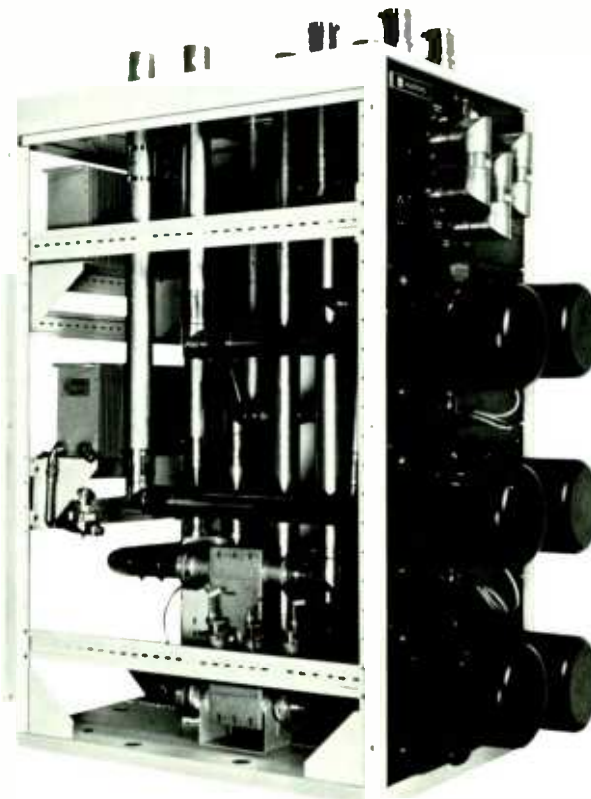

DUALTRAN OUTPUT SWITCHER CABINET

All switches, patch panels, combiners, reject and dummy loads, couplers, sensors and control logic are factory assembled, tested and optimized for best VSWR across the channel. The only external transmission line connections are for the transmitters, antenna and diplexer. This saves installation labor and time, and insures excellent performance without field optimization. Motorized coaxial switches accomplish RF switching at the push of a button on the output switcher control panel, center transmitter control cabinet or via remote control. Solid-state control logic automatically routes command signals to turn off plate voltages, operate proper coaxial switches and re-apply plate voltage . . . all in two seconds or less.

TVD-40L

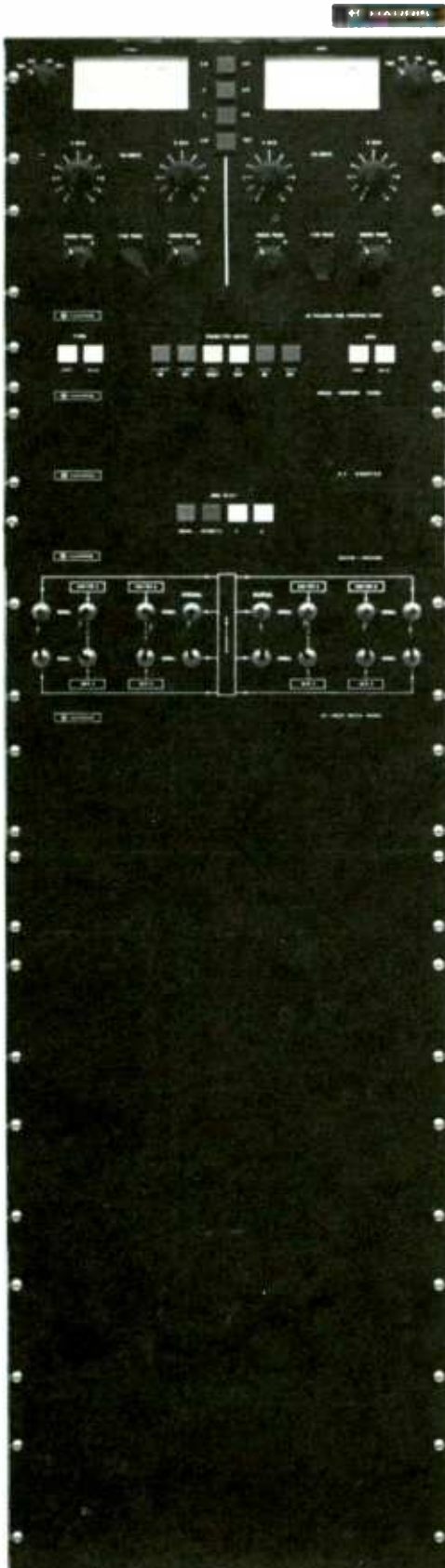

CENTER CONTROL CABINET

All adjustments and control of dual transmitter operation can be accomplished from the control cabinet, supplied as standard equipment in all Harris Dualtran systems. This cabinet is normally mounted between the two independent transmitters to provide a pleasing installation. The RF phasing and control panel, the exciter/modulator switcher, and the local control panel are standard equipment with the Harris Dualtran systems.

RF PHASING AND CONTROL PANEL

Here the output of the on-air exciter/modulator is split to drive the two transmitters. Phasing controls and attenuators provide adjustment of the two signals to assure maximum combined transmitter output. Switchable visual and aural power meters are provided to monitor combined forward, combined reflected and reject power levels. Also, Dualtran output switcher control logic pushbuttons on this panel can select "A + B Air", "A Air", "B Air" or "A + B Test" modes.

LOCAL CONTROL PANEL

Provides simultaneous control of both transmitters including filament and plate on/off and aural and visual raise/lower functions. All system remote control terminals are available on this panel.

EXCITER/MODULATOR SWITCHER

Solid-state control logic provides manual or automatic switching of the two exciter/modulators from "hot standby" to "on-air" status in case of exciter failure. Switching occurs in 10 milliseconds for no perceptible loss of signal.

INPUT PATCH PANEL (Optional)

Permits bypassing the exciter/modulator switcher via BNC cables to patch any combination of aural/visual exciters to any transmitter. This provides extra flexibility for emergency situations and for system maintenance and testing.

RF INPUT BYPASS SWITCHER (Optional—Not Shown)

In single transmitter modes this switcher removes the 3 dB coupler in the RF phasing/control panel from input circuitry, thereby putting full rated power of any one transmitter on the air.

TVD-40L

SOLID-STATE IPAS

The solid-state visual and aural IPAs contain broadband amplifiers, so that periodic bandpass adjustments are not required—and they are fully protected against damage caused by overloads or load variations. For added transmitter protection, RF drive is applied over a one to two second interval, which permits DC voltage stabilization before full RF drive application to power amplifiers. The IPAs are fully metered for monitoring and maintenance, while excellent cooling helps maintain long transistor life.

The two 22.5-kilowatt transmitters each employ a single-ended visual PA (9007 tetrode) and DC filaments in every visual stage for an excellent signal-to-noise ratio.

TRANSVERSAL SIDEBAND (TSB) FILTER

The Harris solid-state sideband filter is an advanced surface acoustic wave design, and shapes visual sidebands at the IF frequency, rather than "on frequency" at the full output power of the transmitter. Unlike previous VSB filters, the TSB filter has an inherent linear phase characteristic and requires no group delay correction or tuning.

SOLID-STATE VISUAL AND AURAL EXCITER/MODULATORS

The Harris solid-state MCP-1V visual exciter/

modulator is an independent, self-contained unit which provides a fully processed on-channel picture signal. Power output can be varied up to one watt with a single front panel control, or from a remote location, without retuning of any kind.

The MCP-1V provides great reliability and stability, excellent frequency response, and truest color quality. It is designed for minimum maintenance and setup time, and for remote control and unattended operation. This is all made possible through the use of the latest design techniques, including Harris' solid-state TSB filter.

The Harris aural exciter/modulator is a solid-state, self-contained unit which furnishes a fully processed aural signal at a level up to 10 watts. Power output can be set with a single knob on the front panel, or by remote control, with no need for retuning. It is mounted in a pull-out drawer, and may be operated with the drawer extended for test purposes.

INTERMEDIATE FREQUENCY (IF) MODULATION

One of the features of the TVD-40L is its true low-level IF Modulation, which offers a top quality picture, and excels in electrical performance, reliability and simplicity of operation.

Due to the low-level techniques, which include the use of devices such as an extremely linear broadband diode ring modulator, low-level sideband filtering and very linear broadband amplifiers, the color signal is a faithful reproduction of the signal applied to the transmitter input.

SOLID-STATE CONTROL CIRCUITS

Solid-state memory, timing and logic circuits offer complete and foolproof control of all transmitter functions. Built-in memory circuitry enables the entire transmitter to return to the air automatically in the state it was operating prior to an AC power interruption.

The control logic, in addition to commanding normal AC control functions, is also used to visually indicate, through indicator lights, the operating status of the transmitter system. These indicator lights allow easy isolation of circuit faults, and are easily removed.

REMOTE CONTROL, UNATTENDED AND AUTOMATIC OPERATION

All control, metering and monitoring circuits have been designed specifically for remote control and ATS. The power controls are motor driven and the necessary remote con-

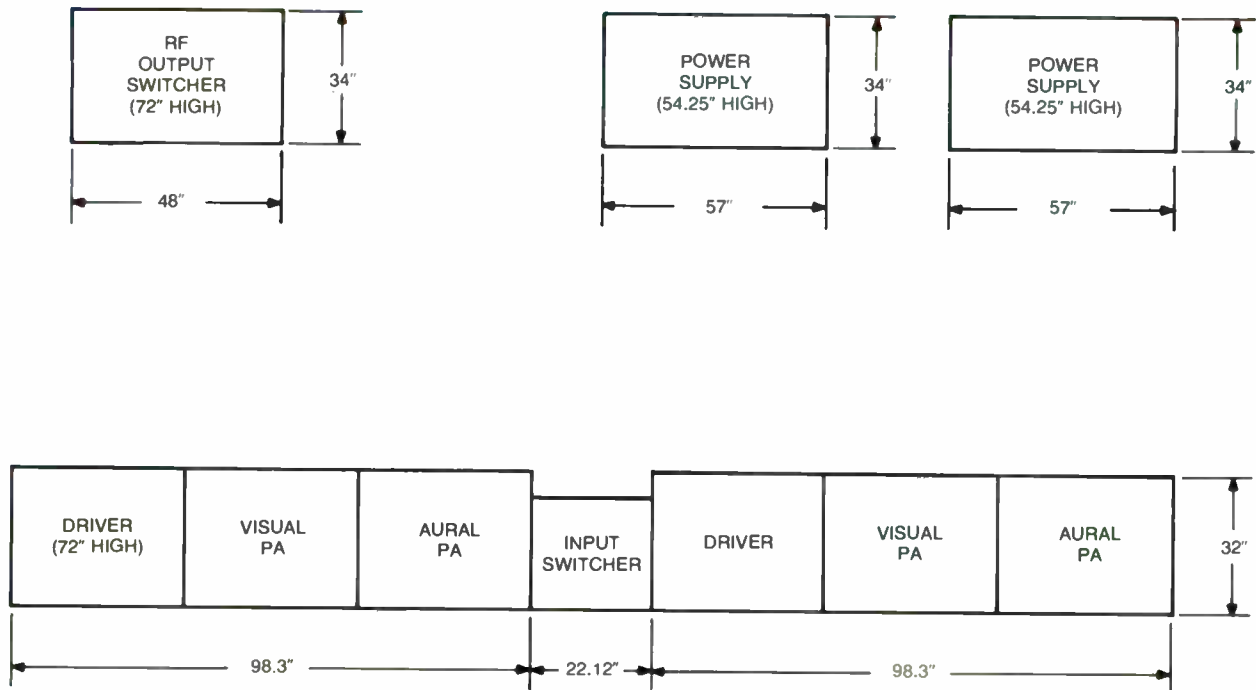

TVD-40L FLOOR PLAN

TVD-40L

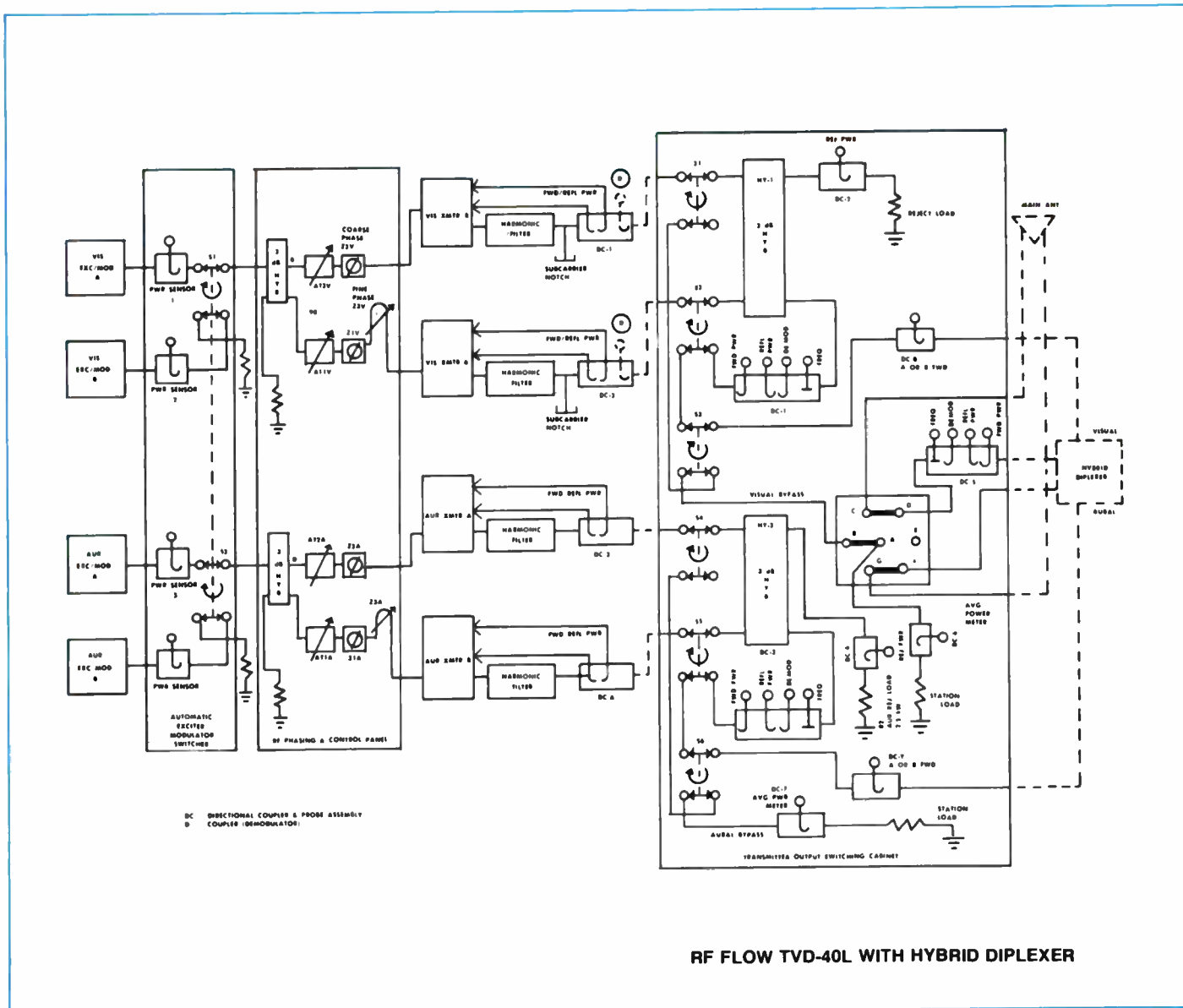

RF FLOW TVD-40L WITH HYBRID DIPLEXER

Control sampling points are built-in on accessible terminal boards. Today, Harris TV transmitters are being operated successfully worldwide with a variety of remote control systems, including the versatile, cost-saving Harris 9100 Facilities Control.

AUTOMATIC POWER CONTROL

Automatic gain control of all RF amplifier stages, in conjunction with the exciter's automatic power control, insures essentially constant power output, even with variations in line voltages. This feature is standard in the TVD-40L.

STABILITY

One factor assuring RF stability is the use of solid-state IPAs and conservatively rated Type 8988 and 9007 ceramic tetrodes operating as VHF linear amplifiers. These amplifier stages operate in a common grid and screen configuration and tube neutralization is not required.

EXCELLENT COOLING SYSTEM

The cooling system of the TVD-40L is quiet and efficient, and employs direct drive blowers, with the motors fully protected by automatic reset devices.

POWER SUPPLIES

The HV power supplies for the TVD-40L visual and aural PAs exhibit very low ripple content. They are designed for excellent regulation and low video impedance for optimum picture performance. In addition, for ease of maintenance, the two power supplies, including transformers and solid-state rectifiers, are housed in two separate assemblies, mounted externally from the transmitter. Routine maintenance access is provided by removable panels.

Vacuum tube filaments in the visual transmit-

ters are operated from DC power supplies to maximize the output signal-to-noise ratio. Grid and screen supplies are 100% solid state.

The visual and aural exciter have their own independent, solid-state regulated power supplies.

EASE OF MAINTENANCE

Convenient access to components is provided, permitting the transmitter to be easily maintained. Visual and aural exciter slide out and can operate independently from the transmitter outside the cabinet. Various exciter circuits, such as oscillators, modulators and processing circuitry, are of modular construction and can be removed for maintenance or replacement.

Easy-to-read, eye-level 4-inch meters are used to monitor required transmitter functions. Meter panels are of double-hinged construction for easy access during maintenance.

TVD-40L SPECIFICATIONS

VISUAL PERFORMANCE

POWER OUTPUT:
LOAD IMPEDANCE:
FREQUENCY RANGE:
CARRIER FREQUENCY STABILITY:¹

REG. OF RF OUTPUT POWER (All black to all white pic.):
VARIATION OF OUTPUT (over one frame):
VISUAL SIDEBAND RESPONSE:²

FREQUENCY RESPONSE VS. BRIGHTNESS:³

VISUAL MODULATION CAPABILITY:

DIFFERENTIAL GAIN:⁴

INCIDENTAL PHASE MODULATION:

LINEARITY (LOW FREQUENCY):⁵

DIFFERENTIAL PHASE:⁴

SIGNAL-TO-NOISE:

Hum and low frequency:⁶

Periodic noise 10 kHz to 5.2 MHz:⁸

Total random and periodic noise unweighted:

K-FACTORS:

EQUIVALENT ENVELOPE DELAY:

VIDEO INPUT LEVEL:

HARMONIC RADIATION:

AURAL PERFORMANCE

POWER OUTPUT:⁷

LOAD IMPEDANCE:

AUDIO INPUT LEVEL:

FREQUENCY DEVIATION:

INPUT IMPEDANCE:

PRE-EMPHASIS:

FREQUENCY RESPONSE:

DISTORTION:⁹

FM NOISE:⁹

INTERCARRIER PHASE MODULATION

(noise):⁹

AM NOISE:

SYNCHRONOUS AM NOISE:⁹

FREQUENCY STABILITY:¹⁰

SERVICE CONDITIONS

AMBIENT TEMPERATURE:¹¹

AMBIENT HUMIDITY RANGE:

ALTITUDE:

PHYSICAL AND MECHANICAL DIMENSIONS:

ELECTRICAL REQUIREMENTS:

System M/NTSC

45 kW peak.

50 ohms. Output connectors: 3/8" EIA standard.

54-88 MHz (Channels 2-6).

±250 Hz (maximum variation over 30 days).

±2 Hz with optional precise frequency control.

3% or less relative to sync peak.

Less than 2%.

-3.58 MHz -42 dB or better

-1.25 MHz and lower -26 dB or better

-0.75 MHz to +4.10 MHz ±0.5 dB

+4.18 MHz +0.5, -1 dB

+4.75 MHz and higher -30 dB or better

±0.75 dB.

0%.

3% or better.

±3° or better relative to blanking.

1.0 dB or better.

±1° or better.

-55 dB or better peak to peak.

-40 dB peak to peak.

-55 dB RMS or better relative to sync peak.

2T 2%, 20T less than 5% baseline disturbance.

0.2 to 2.1 MHz

±40 ns

at 3.58 MHz

±25 ns

at 4.18 MHz

±60 ns

(referenced to FCC standard curve)

75 ohm, -30 dB or better return loss up to 5.5 MHz.

-80 dB relative to peak of sync.

9 kW.

50 ohms. Output connector: 1/8" EIA standard, unflanged.

+10 dBm, ±2 dB.

±25 kHz.

600 ohms, balanced.

75 microseconds.

±0.5 dB rel. to pre-emphasis curve, (30-15,000 Hz).

0.5% THD or less with ±25 kHz deviation from 30-15,000 Hz.

-60 dB RMS or better rel. to ±25 kHz dev.

-46 dB RMS or better rel. to ±25 kHz dev.

-55 dB RMS rel. to 100% amplitude modulation of aural carrier.

-40 dB RMS or better.

±20 Hz (maximum variation over 30 days).

-10° to +50° C (14° to 122° F).

0 to 95% relative humidity.

Sea level to 10,000 feet.

Transmitters (2): each 98.3" W x 32" D x 72" H. Weight each: 2,200 lbs. Switcher

cabinet (without side panels): 22 1/8" W x 24 3/8" D (with front and rear doors) x

72" H. Weight: 300 lbs. RF Output Switcher: 48" W x 34" D x 72" H. Weight:

1,350 lbs. Power Supplies (2): each 57" W x 34" D x 54.25" H. Weight each:

1,500 lbs.

Power input: 208/240 volts, ±11 volts, 3 phase, 50/60 Hz. Power consumption:

112 kW, black picture: 96 kW, average picture.

SPECIFICATIONS SUBJECT TO CHANGE WITHOUT NOTICE.

¹ After initial aging of 60 days.

² Response specified for transmitter operating into a resistive load of 1.05 VSWR or better.

³ Measured using 20% p.p. amplitude swept video modulation with pedestal set at black 10%, white 90% with reference to grey level 50%. All percentages relative to blanking to white excursion.

⁴ Measured with 5-step riser signal from 75% to 12.5% of sync peak. Sub-carrier mod. percentage 12.5% peak to peak.

⁵ Measured with a 5-step riser signal. Test signal No. 3 CCIR REC 421-3.

⁶ Noise measured with respect to a blanking to white transition.

⁷ Capable of additional 0.5 dB power output above rated output to compensate for diplexer loss.

⁸ After de-emphasis.

⁹ Rel. to 100% amplitude modulation at rated deviation.

¹⁰ Relative to frequency offset of 4.5 MHz (System M), from the visual carrier, after initial aging of 60 days.

¹¹ Derate 2° C per 1000 feet (305 meters) altitude above sea level.

ORDERING INFORMATION

TVD-40L, 45 kW dual VHF-TV transmitter for System M standards service, Channels 2-6, with operating tubes, semiconductors, crystals, VSB filter, harmonic and color notch filters, output combiner, input and output switchers 994-8609-001



HARRIS

TV-30L 30-Kilowatt VHF Low Band Color Television Transmitter

- Ultra-linear driver with solid-state IPAs for maximum reliability and signal transparency
- Advanced Transversal SideBand (TSB) filter—requires no group delay correction, no tuning adjustments
- Superior color performance, with minimal correction circuitry
- IF Modulation of the visual and aural carriers
- Automatic power control insures essentially constant power output
- Solid-state memory, timing and logic circuits
- Easily interfaced with ATS and remote control systems
- Emergency multiplex option

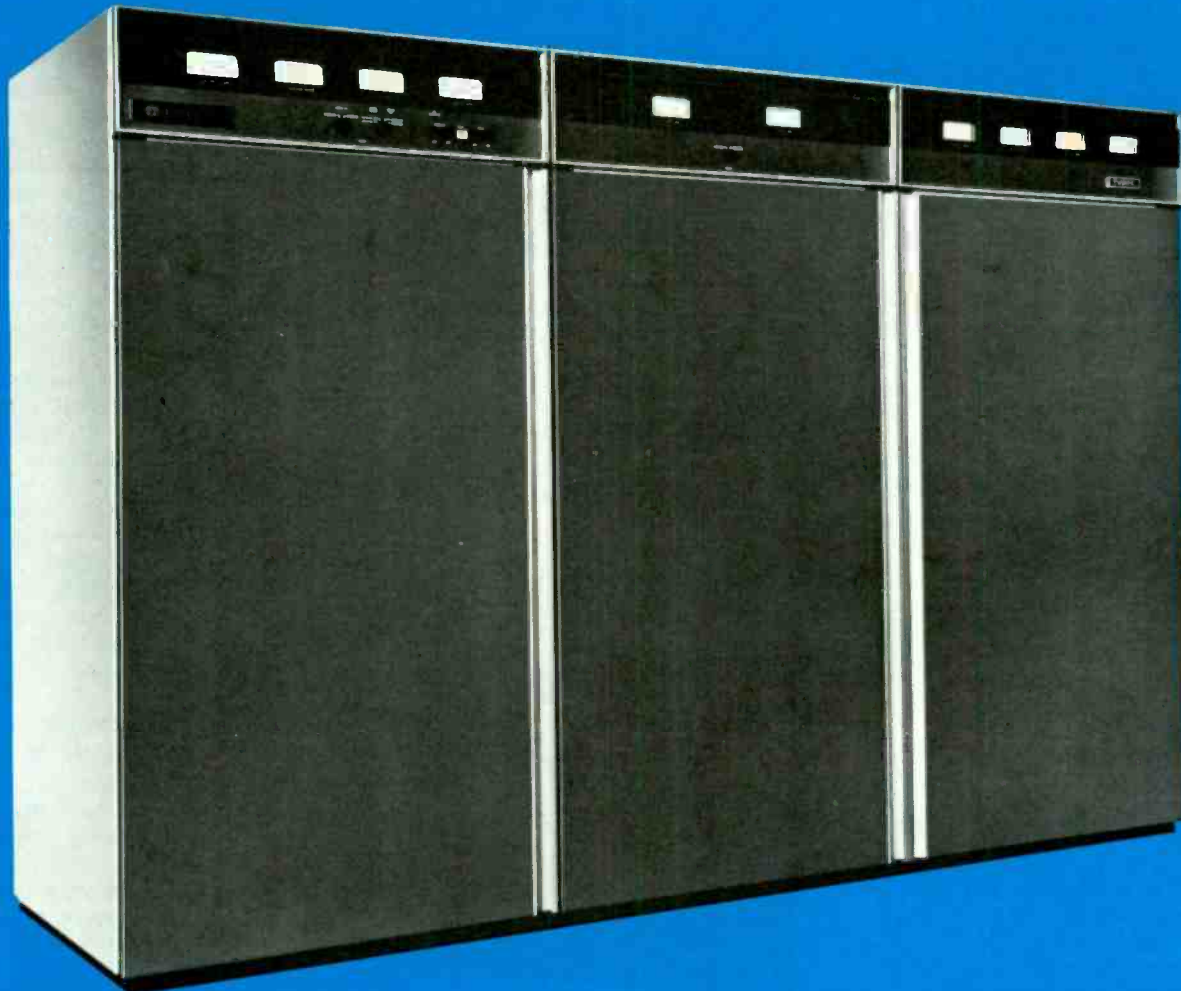

TV-30L . . . straightforward design for top

Harris' TV-30L, 30-kilowatt low band VHF television transmitter, is the most cost-effective TV transmitter available in its power range. Its straightforward design requires less complicated circuitry to meet the high performance standards demanded by today's discriminating broadcaster. And less complicated circuitry means greater reliability . . . the type of year-in, year-out dependability broadcasters need for impressive bottom line results.

The ultra-linear driver employs a broadband Class A solid-state IPA and a single conservatively-operated tetrode to drive the final visual amplifier. This means maximum linearity and signal transparency without the need for complicated correction circuitry . . . for unmatched reliability and maintainability.

The solid-state visual and aural IPAs not only enhance reliability, but also reduce tuning requirements, as they contain broadband amplifiers so that periodic bandpass adjustment is not required. They are fully protected against damage caused by overloads or load variations. For added transmitter protection, RF drive is applied over a one to two second interval, which permits DC voltage stabilization before full RF drive application to power amplifiers. The IPAs are fully metered for monitoring and maintenance, while excellent cooling helps maintain long transistor life.

Surface acoustic wave technology is applied to vestigial sideband filtering in the visual exciter.

The Harris solid-state Transversal SideBand (TSB) filter displays a near-ideal bandpass function for Systems M (FCC) and B bandwidths. This, combined with the filter's true linear phase characteristic, offers excellent reproduction of pulse waveforms and encoded information. The TSB filter requires no group delay correction or tuning. Only 1½ square inches in size, it is located on a PC board in the visual exciter.

This compact transmitter requires only three tubes—visual PA, visual driver and aural PA—to provide a 30-kilowatt visual and a 6-kilowatt aural output. Under normal operating conditions the quick heat tubes permit transmitter turn-on within 120 seconds; faster turn-on times are possible in emergency conditions. A circulator between the visual stages minimizes retuning requirements after a tube change.

SUPERB COLOR PERFORMANCE

In addition to the ultra-linear driver, solid-state IPAs and TSB filter, Harris' TV-30L incorporates such features as IF Modulation, true linear operation of power amplifiers, and a solid-state visual exciter/modulator, to

provide the finest color performance available today.

As no envelope delay correction or adjustments are required for the sideband filter, stability, reliability and color quality are greatly enhanced. Frequency adjustment, power output control and amplifier tuning are straightforward and uncomplicated, while conservatively-rated components assure long-term "hands-off" operation and minimum maintenance.

The transmitter employs a single-ended visual PA (9007 tetrode), and DC filaments in every visual stage for an excellent signal-to-noise ratio.

SOLID-STATE VISUAL AND AURAL EXCITER/MODULATORS

The Harris MCP-1V visual exciter/modulator is an independent, self-contained unit which provides a fully processed on-channel picture signal. Power output can be varied up to one watt with a single front panel control, or from a remote location, without retuning of any kind.

The exciter is mounted in a pull-out drawer and may be operated outside the main transmitter for test purposes. A switch and meter mounted on the front panel permit monitoring exciter parameters. Power and video gain controls are motor driven with manual override provision to permit both local and remote adjustment.

The MCP-1V provides great reliability and stability, excellent frequency response, and truest color quality. It is designed for minimum maintenance and set-up time, and for remote control and unattended operation. This is all made possible through the use of the latest design techniques, including Harris' solid-state TSB filter.

The Harris aural exciter/modulator is a solid-state, self-contained unit which furnishes a fully processed aural signal at a level up to 10 watts. Power output can be set with a single knob on the front panel, or by remote control, with no need for retuning. It is mounted in a pull-out drawer, and may be operated with the drawer extended for test purposes.

INTERMEDIATE FREQUENCY (IF) MODULATION

One of the important features of the TV-30L is its true low-level IF Modulation, which offers a top quality picture, and excels in electrical performance, reliability and simplicity of operation.

In the TV-30L the visual and aural exciters generate fully modulated low-level IF signals.



Ultra-linear driver with solid-state IPAs.

reliability and color performance

The output of a common crystal controlled reference oscillator is used to raise the individual IF signal to the desired "on channel" output frequency.

Due to the low-level techniques, which include the use of devices such as an extremely linear broadband diode ring modulator, low-level sideband filtering and very linear broadband amplifiers, the color signal is a faithful reproduction of the signal applied to the transmitter input.

SOLID-STATE CONTROL CIRCUITS

Solid-state memory, timing and logic circuits offer complete and foolproof control of all transmitter functions. Built-in memory circuitry enables the entire transmitter to return to the air automatically in the state it was operating prior to an AC power interruption.

The control logic, in addition to commanding normal AC control functions, is also used to visually indicate, through indicator lights, the operating status of the transmitter system. These indicator lights allow isolation of circuit faults, and are easily removed.

REMOTE CONTROL, UNATTENDED AND AUTOMATIC OPERATION

All control, metering and monitoring circuits have been designed specifically for remote control and ATS. The power controls are motor driven and the necessary remote control sampling points are built-in on accessible terminal boards. Today, Harris TV transmitters are successfully operated worldwide with a variety of remote control systems, including the versatile, cost-saving Harris 9100 Facilities Control.

AUTOMATIC POWER CONTROL

Automatic gain control of all RF amplifier stages, in conjunction with the exciters' automatic power control, insures constant power output, even with variations in line voltages. This feature is standard in the TV-30L.

STABILITY

One factor assuring RF stability is the use of solid-state IPAs and conservatively rated Type 8988 and 9007 ceramic tetrodes operating as VHF linear amplifiers. These amplifier stages operate in a common grid and screen configuration and tube neutralization is not required.

EMERGENCY MULTIPLEX OPTION

This mode of operation enhances the reliability of the transmitter and minimizes lost air time by permitting common amplification of

the visual and aural signals in the visual RF amplifier chain in the event of an aural amplifier failure. This type of operation is possible in the TV-30L because of the low distortion and broadband circuits that are designed into the visual amplifier chain.

EXCELLENT COOLING SYSTEM

The cooling system of the TV-30L is quiet and efficient, and employs direct drive blowers, with the motors fully protected by automatic reset devices.

POWER SUPPLIES

The HV power supply for the visual and aural PAs exhibits very low ripple content. It is designed for excellent regulation and low video impedance for optimum picture performance. In addition, for ease of maintenance, this power supply, including transformer and solid-state rectifiers, is housed in a single assembly, mounted externally from the transmitter. Routine maintenance access is provided by a removable panel.

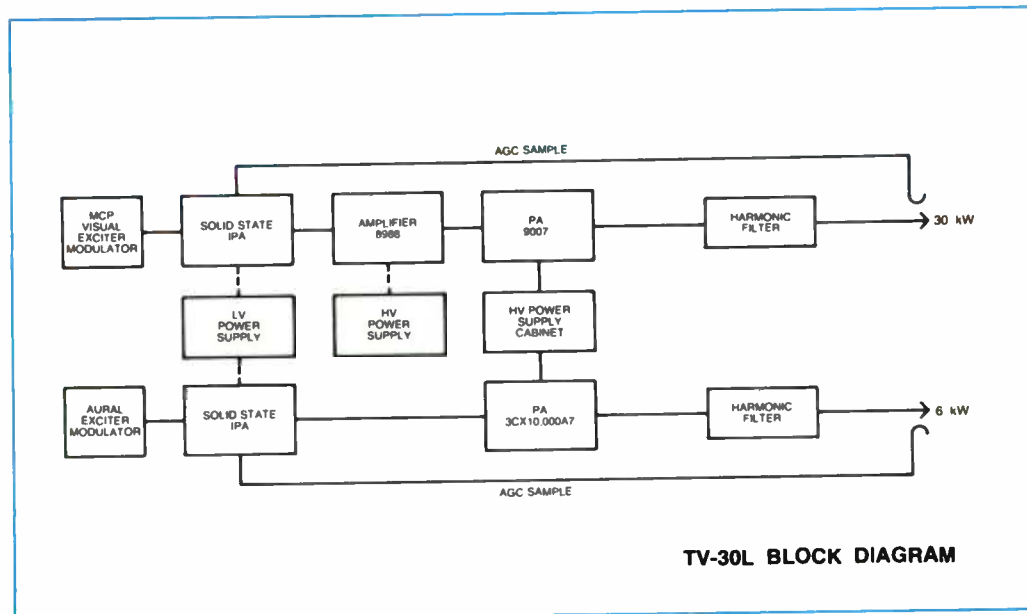

Vacuum tube filaments in the visual transmitter are operated from DC power supplies to maximize the output signal-to-noise ratio. Grid and screen supplies are 100% solid state.

The visual and aural exciters have their own independent, solid-state regulated power supplies.

EASE OF MAINTENANCE

Convenient access to components is provided, permitting the transmitter to be easily maintained. Visual and aural exciters slide out and can operate independently from the transmitter outside the cabinet. Various exciter circuits, such as oscillators, modulators and processing circuitry, are of modular construction and can be removed for maintenance or replacement.

Easy-to-read, eye-level 4-inch meters are used to monitor required transmitter functions. Meter panels are of double-hinged construction for easy access during maintenance.

TV-30L SPECIFICATIONS



VISUAL PERFORMANCE

POWER OUTPUT:
LOAD IMPEDANCE:
FREQUENCY RANGE:
CARRIER FREQUENCY STABILITY:¹
REG. OF RF OUTPUT POWER (All black to all white pic.):
VARIATION OF OUTPUT (over one frame):
VISUAL SIDEBAND RESPONSE:²

FREQUENCY RESPONSE VS. BRIGHTNESS:³

VISUAL MODULATION CAPABILITY:
DIFFERENTIAL GAIN:⁴
INCIDENTAL PHASE MODULATION LINEARITY (LOW FREQUENCY):⁵
DIFFERENTIAL PHASE:⁴
SIGNAL-TO-NOISE:
 Hum and low frequency:⁶
 Periodic noise 10 kHz to 5.2 MHz:⁶
 Total random and periodic noise unweighted:

K-FACTORS:

EQUIVALENT ENVELOPE DELAY:

VIDEO INPUT LEVEL:
HARMONIC RADIATION:

AURAL PERFORMANCE

POWER OUTPUT:⁷
LOAD IMPEDANCE:

AUDIO INPUT LEVEL:
FREQUENCY DEVIATION:
INPUT IMPEDANCE:
PRE-EMPHASIS:
FREQUENCY RESPONSE:

DISTORTION:⁸

FM NOISE:⁹
INTERCARRIER PHASE MODULATION (noise):⁹
AM NOISE:

SYNCHRONOUS AM NOISE:⁹
FREQUENCY STABILITY:¹⁰

SERVICE CONDITIONS

AMBIENT TEMPERATURE:¹¹
AMBIENT HUMIDITY RANGE:
ALTITUDE:
PHYSICAL AND MECHANICAL DIMENSIONS:

ELECTRICAL REQUIREMENTS:

System M/NTSC

30 kW peak.
 50 ohms. Output connectors: 3/8" EIA standard.
 54-88 MHz (Channels 2-6).
 ±250 Hz (maximum variation over 30 days).
 ±2 Hz with optional precise frequency control.

3% or less relative to sync peak.
 Less than 2%.
 -3.58 MHz -42 dB or better
 -1.25 MHz and lower -26 dB or better
 -0.75 MHz to +4.10 MHz ±0.5 dB
 +4.18 MHz +0.5, -1 dB
 +4.75 MHz and higher -30 dB or better

±0.75 dB.
 0%.
 3% or better.
 ±3° or better relative to blanking.
 1.0 dB or better.
 ±1° or better.

-55 dB or better peak to peak.
 -40 dB peak to peak.
 -55 dB RMS or better relative to sync peak.
 2T 2%, 20T less than 5% baseline disturbance.

0.2 to 2.1 MHz ±40 ns
 at 3.58 MHz ±25 ns
 at 4.18 MHz ±60 ns
 (referenced to FCC standard curve)
 75 ohm, -30 dB or better return loss up to 5.5 MHz.
 -80 dB relative to peak of sync.

6 kW.
 50 ohms. Output connector: 1/8" EIA standard, unflanged.
 +10 dBm, ±2 dB.
 ±25 kHz.
 600 ohms, balanced.
 75 microseconds.
 ±0.5 dB rel. to pre-emphasis curve, (30-15,000 Hz).
 0.5% THD or less with ±25 kHz deviation from 30-15,000 Hz.
 -60 dB RMS or better rel. to ±25 kHz dev.

-46 dB RMS or better rel. to ±25 kHz dev.
 -55 dB RMS rel. to 100% amplitude modulation of aural carrier.
 -40 dB RMS or better.
 ±20 Hz (maximum variation over 30 days).

-10° to +50° C (14° to 122° F).
 0 to 95% relative humidity.
 Sea level to 7,500 feet.

Trans.: 98.3" W x 32" D x 72" H. Weight: 2,200 lbs. Power supply:
 57" W x 34" D x 54.25" H. Weight: 1,500 lbs.

Power input: 208/240 volts, ±11 volts, 3 phase, 50/60 Hz. Power consumption:
 60 kW, black picture, 10% aural; 53 kW, average picture (50% APL), 10% aural;
 67 kW, black picture at 20% aural; 60 kW, average picture at 20% aural.

Systems B/PAL and B/SECAM

25 kW peak.
 50 ohms. Output connector: 3/8" EIA standard.
 54-68 MHz (Channels E3 and E4, Band I).
 ±250 Hz (maximum variation over 30 days).

3% or less relative to sync peak.
 Less than 2%.
 -4.43 MHz -30 dB or better
 -1.25 MHz -22 dB or better
 -0.75 MHz to 5.0 MHz ±0.5 dB
 +5.5 MHz -22 dB or better

±0.75 dB.
 0%.
 3% or better.
 ±3° or better relative to blanking.
 10% or better.
 ±1° or better.

-55 dB or better peak to peak.
 -40 dB peak to peak.

-55 dB RMS or better relative to sync peak.
 2T 2%, 20T less than 5% baseline disturbance.
 Transmitter supplied with receiver equalizer compliant with CCIR Report 624, Figure 3, Curve A or B.

75 ohm, -30 dB or better return loss up to 5.5 MHz.
 -80 dB relative to peak of sync.

Up to 6 kW.
 50 ohms. Output connector: 1/8" EIA standard, unflanged.
 0 to +12 dBm.
 ±50 kHz.
 600 ohms, balanced.
 50 microseconds.
 ±0.5 dB rel. to pre-emphasis curve, (30-15,000 Hz).
 1% THD from 30 to 15,000 Hz with ±50 kHz deviation.
 Less than 2% at ±70 kHz deviation.
 -60 dB RMS or better rel. to ±50 kHz dev.

-46 dB RMS or better rel. to ±50 kHz dev.
 -55 dB RMS rel. to 100% amplitude modulation of aural carrier.
 -40 dB RMS or better.
 ±20 Hz (maximum variation over 30 days).

-10° to +50° C.
 0 to 95% relative humidity.
 Sea level to 2286 meters.

Trans.: 249.7 cm W x 81.3 cm D x 182.9 cm H. Weight: 998 kg. Power supply:
 144.8 cm W x 86.4 cm D x 137.8 cm H. Weight: 680 kg.

Power input: 380/415 volts, ±17 volts, 3 phase, 50/60 Hz. Power consumption:
 60 kW, black picture, 10% aural;
 53 kW, average picture (50% APL), 10% aural; 67 kW, black picture at 20% aural;
 60 kW, average picture at 20% aural.

SPECIFICATIONS SUBJECT TO CHANGE WITHOUT NOTICE.

¹ After initial aging of 60 days.
² Response specified for transmitter operating into a resistive load of 1.05 VSWR or better.
³ Measured using 20% p.p. amplitude swept video modulation with pedestal set at black 10%, white 90% with reference to grey level 50%. All percentages relative to blanking to white excursion.
⁴ Measured with 5-step riser signal from 75% to 12.5% of sync peak. Sub-carrier mod. percentage 12.5% peak to peak.
⁵ Measured with a 5-step riser signal. Test signal No. 3 CCIR REC 421-3.
⁶ Noise measured with respect to a blanking to white transition.
⁷ Capable of additional 0.5 dB power output above rated output to compensate for diplexer loss.
⁸ After de-emphasis.
⁹ Rel. to 100% amplitude modulation at rated deviation.
¹⁰ Relative to frequency offset of 4.5 MHz (System M), 5.5 MHz (System B), from the visual carrier, after initial aging of 60 days.
¹¹ Derate 2° C per 1000 feet (305 meters) altitude above sea level.

ORDERING INFORMATION

TV-30L, 30 kW VHF-TV transmitter for System M service, Channels 2-6, complete with operating tubes, semiconductors, crystals, required pre-correction circuitry, low-level vestigial sideband filter, harmonic and color notch filters, 208/240 volts, 50/60 Hz 994-8532-001
 TV-30L, 25 kW VHF-TV transmitter for System B service, 54-68 MHz (Channels E3 and E4, Band I), complete with operating tubes, semiconductors, crystals, required pre-correction circuitry, low-level vestigial sideband filter, harmonic filter, 308/415 volts, 50/60 Hz 994-8532-002



TV-20L
22.5-Kilowatt VHF
Low Band
Color Television
Transmitter

- Ultra-linear driver with solid-state IPAs for maximum reliability and signal transparency
- Advanced Transversal SideBand (TSB) filter—requires no group delay correction, no tuning adjustments
- Superior color performance, with minimal correction circuitry
- IF Modulation of the visual and aural carriers
- Automatic power control insures essentially constant power output
- Solid-state memory, timing and logic circuits
- Easily interfaced with ATS and remote control systems
- Emergency multiplex option

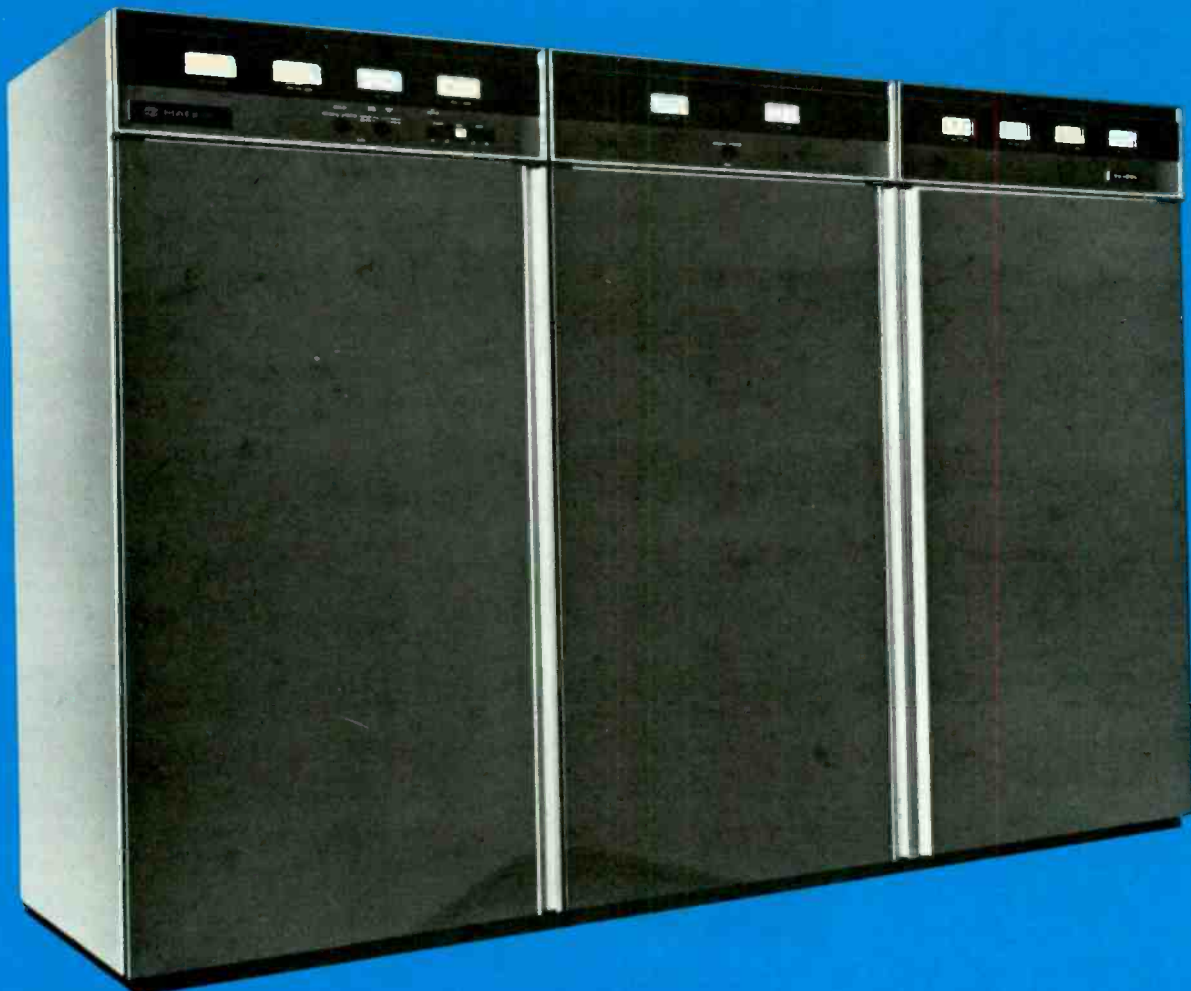

TV-20L . . . straightforward design for top

Harris' TV-20L, 22.5-kilowatt low band VHF television transmitter, is the most cost-effective TV transmitter available in its power range. Its straightforward design requires less complicated circuitry to meet the high performance standards demanded by today's discriminating broadcaster. And less complicated circuitry means greater reliability . . . the type of year-in, year-out dependability broadcasters need for profitable results.

The ultra-linear driver employs a broadband Class A solid-state IPA and a single conservatively-operated tetrode to drive the final visual amplifier. This means maximum linearity and signal transparency without the need for complicated correction circuitry . . . for unmatched reliability and maintainability.

The solid-state visual and aural IPAs not only enhance reliability, but also reduce tuning requirements, as they contain broadband amplifiers so that periodic bandpass adjustment is not required. They are fully protected against damage caused by overloads or load variations. For added transmitter protection, RF drive is applied over a one to two second interval, which permits DC voltage stabilization before full RF drive application to power amplifiers. The IPAs are fully metered for monitoring and maintenance, while excellent cooling helps maintain long transistor life.

Surface acoustic wave technology is applied to vestigial sideband filtering in the visual exciter.

The Harris solid-state Transversal SideBand (TSB) filter displays a near-ideal bandpass function for Systems M (FCC) and B bandwidths. This, combined with the filter's true linear phase characteristic, offers excellent reproduction of pulse waveforms and encoded information. The TSB filter requires no group delay correction or tuning. Only 1½ square inches in size, it is located on a PC board in the visual exciter.

This compact transmitter requires only three tubes—visual PA, visual driver and aural PA—to provide a 22.5-kilowatt visual and a 4.5-kilowatt aural output. Under normal operating conditions the quick heat tubes permit transmitter turn-on within 120 seconds; faster turn-on times are possible in emergency conditions. A circulator between the visual stages minimizes retuning requirements after a tube change.

SUPERB COLOR PERFORMANCE

In addition to the ultra-linear driver, solid-state IPAs and TSB filter, Harris' TV-20L incorporates such features as IF Modulation, true linear operation of power amplifiers, and a solid-state visual exciter/modulator, to

provide the finest color performance available today.

As no envelope delay correction or adjustments are required for the sideband filter, stability, reliability and color quality are greatly enhanced. Frequency adjustment, power output control and amplifier tuning are straightforward and uncomplicated, while conservatively-rated components assure long-term "hands-off" operation and minimum maintenance.

The transmitter employs a single-ended visual PA (9007 tetrode), and DC filaments in every visual stage for an excellent signal-to-noise ratio.

SOLID-STATE VISUAL AND AURAL EXCITER/MODULATORS

The Harris MCP-1V visual exciter/modulator is an independent, self-contained unit which provides a fully processed on-channel picture signal. Power output can be varied up to one watt with a single front panel control, or from a remote location, without retuning of any kind.

The exciter is mounted in a pull-out drawer and may be operated outside the main transmitter for test purposes. A switch and meter mounted on the front panel permit monitoring exciter parameters. Power and video gain controls are motor driven with manual override provision to permit both local and remote adjustment.

The MCP-1V provides great reliability and stability, excellent frequency response, and truest color quality. It is designed for minimum maintenance and set-up time, and for remote control and unattended operation. This is all made possible through the use of the latest design techniques, including Harris' solid-state TSB filter.

The Harris aural exciter/modulator is a solid-state, self-contained unit which furnishes a fully processed aural signal at a level up to 10 watts. Power output can be set with a single knob on the front panel, or by remote control, with no need for retuning. It is mounted in a pull-out drawer, and may be operated with the drawer extended for test purposes.

INTERMEDIATE FREQUENCY (IF) MODULATION

One of the important features of the TV-20L is its true low-level IF Modulation, which offers a top quality picture, and excels in electrical performance, reliability and simplicity of operation.

In the TV-20L the visual and aural exciters generate fully modulated low-level IF signals.



Ultra-linear driver with solid-state IPAs.

reliability and color performance

The output of a common crystal controlled reference oscillator is used to raise the individual IF signal to the desired "on channel" output frequency.

Due to the low-level techniques, which include the use of devices such as an extremely linear broadband diode ring modulator, low-level sideband filtering and very linear broadband amplifiers, the color signal is a faithful reproduction of the signal applied to the transmitter input.

SOLID-STATE CONTROL CIRCUITS

Solid-state memory, timing and logic circuits offer complete and foolproof control of all transmitter functions. Built-in memory circuitry enables the entire transmitter to return to the air automatically in the state it was operating prior to an AC power interruption.

The control logic, in addition to commanding normal AC control functions, is also used to visually indicate, through indicator lights, the operating status of the transmitter system. These indicator lights allow isolation of circuit faults, and are easily removed.

REMOTE CONTROL, UNATTENDED AND AUTOMATIC OPERATION

All control, metering and monitoring circuits have been designed specifically for remote control and ATS. The power controls are motor driven and the necessary remote control sampling points are built-in on accessible terminal boards. Today, Harris TV transmitters are successfully operated worldwide with a variety of remote control systems, including the versatile, cost-saving Harris 9100 Facilities Control.

AUTOMATIC POWER CONTROL

Automatic gain control of all RF amplifier stages, in conjunction with the exciter's automatic power control, insures constant power output, even with variations in line voltages. This feature is standard in the TV-20L.

STABILITY

One factor assuring RF stability is the use of solid-state IPAs and conservatively rated Type 8988 and 9007 ceramic tetrodes operating as VHF linear amplifiers. These amplifier stages operate in a common grid and screen configuration and tube neutralization is not required.

EMERGENCY MULTIPLEX OPTION

This mode of operation enhances the reliability of the transmitter and minimizes lost air time by permitting common amplification of

the visual and aural signals in the visual RF amplifier chain in the event of an aural amplifier failure. This type of operation is possible in the TV-20L because of the low distortion and broadband circuits that are designed into the visual amplifier chain.

EXCELLENT COOLING SYSTEM

The cooling system of the TV-20L is quiet and efficient, and employs direct drive blowers, with the motors fully protected by automatic reset devices.

POWER SUPPLIES

The HV power supply for the visual and aural PAs exhibits very low ripple content. It is designed for excellent regulation and low video impedance for optimum picture performance. In addition, for ease of maintenance, this power supply, including transformer and solid-state rectifiers, is housed in a single assembly, mounted externally from the transmitter. Routine maintenance access is provided by a removable panel.

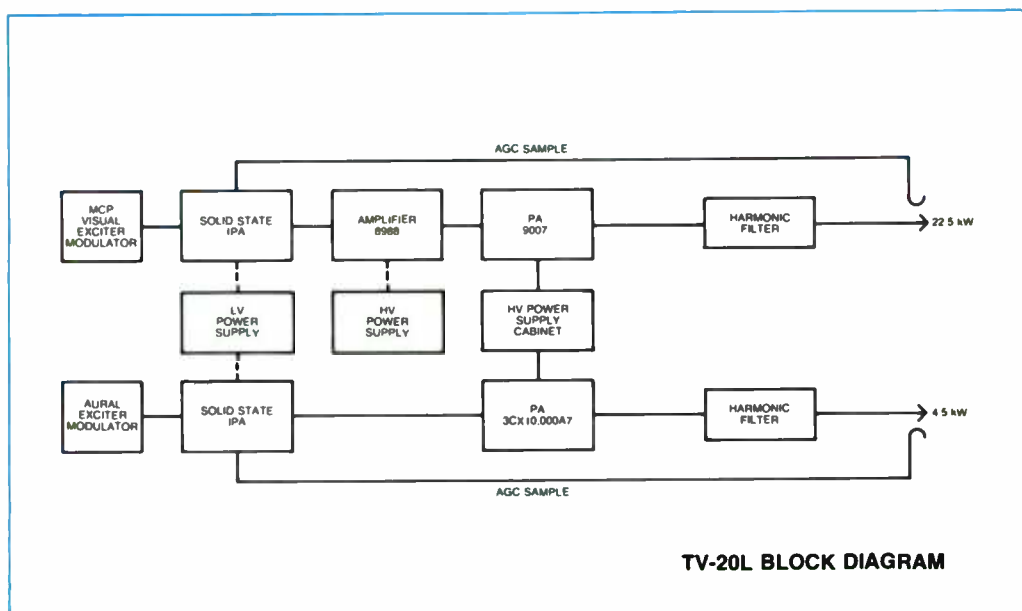

Vacuum tube filaments in the visual transmitter are operated from DC power supplies to maximize the output signal-to-noise ratio. Grid and screen supplies are 100% solid state.

The visual and aural exciter have their own independent, solid-state regulated power supplies.

EASE OF MAINTENANCE

Convenient access to components is provided, permitting the transmitter to be easily maintained. Visual and aural exciter slide out and can operate independently from the transmitter outside the cabinet. Various exciter circuits, such as oscillators, modulators and processing circuitry, are of modular construction and can be removed for maintenance or replacement.

Easy-to-read, eye-level 4-inch meters are used to monitor required transmitter functions. Meter panels are of double-hinged construction for easy access during maintenance.

TV-20L SPECIFICATIONS

VISUAL PERFORMANCE

POWER OUTPUT:
LOAD IMPEDANCE:
FREQUENCY RANGE:
CARRIER FREQUENCY STABILITY:¹

REG. OF RF OUTPUT POWER (All black to all white pic.):
VARIATION OF OUTPUT (over one frame):
VISUAL SIDEBAND RESPONSE:²

FREQUENCY RESPONSE VS. BRIGHTNESS:³

VISUAL MODULATION CAPABILITY:
DIFFERENTIAL GAIN:⁴
INCIDENTAL PHASE MODULATION:
LINEARITY (LOW FREQUENCY):⁵
DIFFERENTIAL PHASE:⁴
SIGNAL-TO-NOISE:

Hum and low frequency:⁶
Periodic noise 10 kHz to 5.2 MHz:⁶
Total random and periodic noise unweighted:

K-FACTORS:

EQUIVALENT ENVELOPE DELAY:

VIDEO INPUT LEVEL:
HARMONIC RADIATION:

AURAL PERFORMANCE

POWER OUTPUT:⁷
LOAD IMPEDANCE:

AUDIO INPUT LEVEL:
FREQUENCY DEVIATION:
INPUT IMPEDANCE:
PRE-EMPHASIS:
FREQUENCY RESPONSE:

DISTORTION:⁸

FM NOISE:⁹
INTERCARRIER PHASE MODULATION (noise):⁸
AM NOISE:

SYNCHRONOUS AM NOISE:⁹
FREQUENCY STABILITY:¹⁰

SERVICE CONDITIONS

AMBIENT TEMPERATURE:¹¹
AMBIENT HUMIDITY RANGE:
ALTITUDE:
PHYSICAL AND MECHANICAL DIMENSIONS:

ELECTRICAL REQUIREMENTS:

System M/NTSC

22.5 kW peak.
 50 ohms. Output connectors: 3/16" EIA standard.
 54-88 MHz (Channels 2-6).
 ± 250 Hz (maximum variation over 30 days).
 ± 2 Hz with optional precise frequency control.

3% or less relative to sync peak.
 Less than 2%.
 - 3.58 MHz - 42 dB or better
 - 1.25 MHz and lower - 26 dB or better
 - 0.75 MHz to + 4.10 MHz ± 0.5 dB
 + 4.18 MHz + 0.5, - 1 dB
 + 4.75 MHz and higher - 30 dB or better

± 0.75 dB.
 0%.
 3% or better.
 ± 3° or better relative to blanking.
 1.0 dB or better.
 ± 1° or better.

- 55 dB or better peak to peak.
 - 40 dB peak to peak.

- 55 dB RMS or better relative to sync peak.
 2T 2%, 20T less than 5% baseline disturbance.
 0.2 to 2.1 MHz ± 40 ns
 at 3.58 MHz ± 25 ns
 at 4.18 MHz ± 60 ns
 (referenced to FCC standard curve)
 75 ohm, - 30 dB or better return loss up to 5.5 MHz.
 - 80 dB relative to peak of sync.

4.5 kW.
 50 ohms. Output connector: 1 1/8" EIA standard, unflanged.
 + 10 dBm, ± 2 dB.
 ± 25 kHz.
 600 ohms, balanced.
 75 microseconds.
 ± 0.5 dB rel. to pre-emphasis curve, (30-15,000 Hz).
 0.5% THD or less with ± 25 kHz deviation from 30-15,000 Hz.
 - 60 dB RMS or better rel. to ± 25 kHz dev.
 - 46 dB RMS or better rel. to ± 25 kHz dev.
 - 55 dB RMS rel. to 100% amplitude modulation of aural carrier.
 - 40 dB RMS or better.
 ± 20 Hz (maximum variation over 30 days).

- 10° to + 50° C (14° to 122° F).
 0 to 95% relative humidity.
 Sea level to 10,000 feet.

Trans.: 98.3" W x 32" D x 72" H. Weight:
 2,200 lbs. Power supply:
 57" W x 34" D x 54.25" H. Weight: 1,500 lbs.

Power input: 208/240 volts, ± 11 volts,
 3 phase, 50/60 Hz. Power consumption:
 55 kW, black picture, 10% aural; 47 kW, average picture (50% APL), 10% aural;
 60 kW, black picture at 20% aural; 51 kW, average picture at 20% aural.

Systems B/PAL and B/SECAM

20 kW peak.
 50 ohms. Output connector: 3/16" EIA standard.
 54-68 MHz (Channels E3 and E4, Band I).
 ± 250 Hz (maximum variation over 30 days).

3% or less relative to sync peak.
 Less than 2%.
 - 4.43 MHz - 30 dB or better
 - 1.25 MHz - 22 dB or better
 - 0.75 MHz to 5.0 MHz ± 0.5 dB
 + 5.5 MHz - 22 dB or better

± 0.75 dB.
 0%.
 3% or better.
 ± 3° or better relative to blanking.
 10% or better.
 ± 1° or better.

- 55 dB or better peak to peak.
 - 40 dB peak to peak.

- 55 dB RMS or better relative to sync peak.
 2T 2%, 20T less than 5% baseline disturbance.
 Transmitter supplied with receiver equalizer compliant with CCIR Report 624, Figure 3, Curve A or B.

75 ohm, - 30 dB or better return loss up to 5.5 MHz.
 - 80 dB relative to peak of sync.

Up to 4 kW.
 50 ohms. Output connector: 1 1/8" EIA standard, unflanged.
 0 to + 12 dBm.
 ± 50 kHz.
 600 ohms, balanced.
 50 microseconds.
 ± 0.5 dB rel. to pre-emphasis curve, (30-15,000 Hz).
 1% THD from 30 to 15,000 Hz with ± 50 kHz deviation.
 Less than 2% at ± 70 kHz deviation.
 - 60 dB RMS or better rel. to ± 50 kHz dev.
 - 46 dB RMS or better rel. to ± 50 kHz dev.
 - 55 dB RMS rel. to 100% amplitude modulation of aural carrier.
 - 40 dB RMS or better.
 ± 20 Hz (maximum variation over 30 days).

- 10° to + 50° C.
 0 to 95% relative humidity.
 Sea level to 3048 meters.

Trans.: 249.7 cm W x 81.3 cm D x 182.9 cm H.
 Weight: 998 kg. Power supply:
 144.8 cm W x 86.4 cm D x 137.8 cm H. Weight:
 680 kg.

Power input: 380/415 volts, ± 17 volts,
 3 phase, 50/60 Hz. Power consumption:
 55 kW, black picture, 10% aural;
 47 kW, average picture (50% APL),
 10% aural; 60 kW, black picture at 20% aural;
 51 kW, average picture at 20% aural.

SPECIFICATIONS SUBJECT TO CHANGE WITHOUT NOTICE.

¹ After initial aging of 60 days.

² Response specified for transmitter operating into a resistive load of 1.05 VSWR or better.

³ Measured using 20% p.p. amplitude swept video modulation with pedestal set at black 10%, white 90% with reference to grey level 50%. All percentages relative to blanking to white excursion.

⁴ Measured with 5-step riser signal from 75% to 12.5% of sync peak. Sub-carrier mod. percentage 12.5% peak to peak.

⁵ Measured with a 5-step riser signal. Test signal No. 3 CCIR REC 421-3.

⁶ Noise measured with respect to a blanking to white transition.

⁷ Capable of additional 0.5 dB power output above rated output to compensate for diplexer loss.

⁸ After de-emphasis.

⁹ Rel. to 100% amplitude modulation at rated deviation.

¹⁰ Relative to frequency offset of 4.5 MHz (System M), 5.5 MHz (System B), from the visual carrier, after initial aging of 60 days.

¹¹ Derate 2° C per 1000 feet (305 meters) altitude above sea level.

ORDERING INFORMATION

TV-20L, 22.5 kW VHF-TV transmitter for System M service, Channels 2-6, complete with operating tubes, semiconductors, crystals, required pre-correction circuitry, low-level vestigial sideband filter, harmonic and color notch filters, 208/240 volts, 50/60 Hz 994-8608-001

TV-20L, 20 kW VHF-TV transmitter for System B service, 54-68 MHz (Channels E3 and E4, Band I), complete with operating tubes, semiconductors, crystals, required pre-correction circuitry, low-level vestigial sideband filter, harmonic filter, 308/415 volts, 50/60 Hz 994-8608-002



HARRIS

MCP-1V

VHF-TV Visual Exciter/Modulator

- More than a two-to-one improvement in color performance specifications
- TSB (Transversal SideBand) filter requires no group delay correction, no adjustments—only 1½ inches square
- Exciter interfaces with all Harris' VHF IF Modulation transmitters
- Excellent reliability and stability
- Easy serviceability

With the introduction of the MCP-1V visual exciter/modulator, Harris presents the television industry with the best color performance specifications ever offered in VHF-TV transmitting equipment! This dramatic advancement in color performance is made possible through the use of IF Modulation, pioneered in the United States by Harris, and through the use of recent breakthroughs in filtering technology. In the MCP-1V, Harris has combined IF Modulation and Transversal SideBand filtering to achieve better than two-to-one improvements in the important color parameters of differential phase, differential gain and frequency response.

TRANSVERSAL SIDEBAND FILTER. The Harris solid-state vestigial sideband filter is an advanced surface acoustic wave design, and shapes visual sidebands at the IF frequency, rather than "on frequency" at the full output power of the transmitter. Unlike conventional filters, the TSB filter has an inherent linear phase characteristic, which means that it requires no group delay correction. A conventional filter requires from 600 to 1000 nsec of group delay correction, and many adjustments—the TSB filter requires no correction or adjustments—ever! A conventional filter needs 6 to 12 tuning controls—the TSB filter needs no tuning controls. As no envelope delay correction or adjustments are required, color quality, stability and reliability are greatly enhanced. The TSB filter also offers great temperature stability, and is unaffected by aging.

In addition, the TSB filter has steeper skirts and higher attenuation outside the channel passband for improved wave shaping.

Only 1½ square inches in size, the filter is mounted on a PC board in the MCP-1V.

IF MODULATION. The refined IF Modulation techniques used in the MCP-1V offer inherently low values in differential phase and differential gain without the use of complex precorrection or feedback circuits. Additional gain and phase corrector boards may be plugged into the exciter to permit optimum performance at either of two transmitter power levels.

INDEPENDENT, SELF-CONTAINED UNIT. The maximum color performance MCP-1V is an independent, self-contained unit which provides a fully processed on-channel picture signal. Power output can be varied up to one watt with a single front panel control with no adjustment of transmitter tuning controls.

The exciter is mounted in a pull-out drawer, and may be operated outside the main transmitter for test purposes. It is designed for minimum maintenance and set-up time, and for remote control and unattended operation.

The MCP-1V is standard in all of Harris' L2 and H2 TV transmitters—and interfaces easily with any Harris VHF IF Modulation transmitter. See the reverse side for specifications and ordering information.



MCP-1V



TSB Filter mounted on PC board

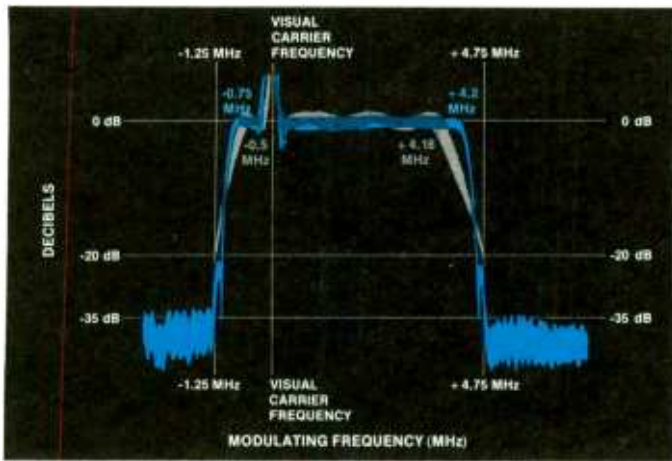

Sideband response of MCP-1V exciter (In blue) showing improvement over typical response of older exciters (shown in gray).

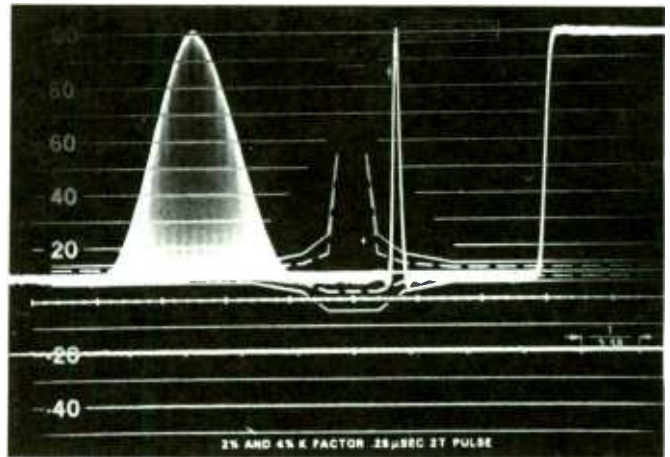

Waveforms of 12.5t, 2t and window pulses showing response through the MCP-1V visual exciter.

MCP-1V SPECIFICATIONS

VISUAL PERFORMANCE

POWER OUTPUT:
 OUTPUT IMPEDANCE:
 FREQUENCY RANGE:
 CARRIER STABILITY:¹
 REG. OF RF OUTPUT POWER (Black to white pic.):
 VARIATION OF OUTPUT (over one frame):
 VISUAL SIDEBAND RESPONSE:

FREQUENCY RESPONSE VS. BRIGHTNESS:²
 VISUAL MODULATION CAPABILITY:
 DIFFERENTIAL GAIN:³
 LINEARITY (LOW FREQUENCY):

DIFFERENTIAL PHASE:⁴
 SIGNAL-TO-NOISE RATIO:
 K FACTORS:
 EQUIVALENT ENVELOPE DELAY:

VIDEO INPUT:⁵
 HARMONIC RADIATION⁶

SERVICE CONDITIONS

AMBIENT TEMPERATURE:
 AMBIENT HUMIDITY RANGE:
 ALTITUDE:
 PHYSICAL AND MECHANICAL DIMENSIONS:

ELECTRICAL REQUIREMENTS:

FCC

One watt peak of sync.
 50 ohms unbalanced. Output connector: BNC.
 Channels 2-6 (54-88 MHz) or Channels 7-13 (174-216 MHz).
 ± 250 Hz (maximum variation per month).
 1% or less.
 1% or less.
 -1.25 MHz and lower -30 dB
 Carrier to -0.75 MHz ± 0.5 dB
 Carrier 0 dB reference
 Carrier to +4.20 MHz ± 0.5 dB
 +4.75 MHz and higher -30 dB
 ± 0.25 dB.
 3% or better.
 3% maximum.
 0.5 dB or better.

$\pm 1^\circ$ maximum.
 -58 dB or better (RMS) below sync level.
 2t 2%, 12.5t less than 5% baseline disturbance.
 0.5 to 2.1 MHz: ± 40 ns
 at 3.58 MHz: ± 30 ns
 at 4.18 MHz: ± 60 ns
 (referenced to standard curve-FCC)
 75 ohm, terminated.
 -20 dB.

-10° to +60° C (14° to 140° F).
 0 to 95% relative humidity.
 Sea level to 10,000 feet.
 24" W x 22" D x 5.25" H. Weight: 38 lbs.

105-125 VAC or 210-250 VAC, 50/60 Hz. Power consumption: 150 VA maximum.

CCIR (System "B")

One watt peak of sync.
 50 ohms unbalanced. Output connector: BNC.
 Band I: E3-E4 (54-68 MHz) or Band III: E5-E11 (174-223 MHz).
 ± 250 Hz (maximum variation per month).
 1% or less.
 1% or less.
 -1.25 MHz and lower -30 dB
 +1.5 MHz to -0.75 MHz ± 0.5 dB
 +1.5 MHz 0 dB reference
 +1.5 MHz to 5.0 MHz ± 0.5 dB
 +5.5 MHz and higher -30 dB
 ± 0.25 dB.

3% or better.
 3% maximum.
 Amplitude dev. min/s max. better than 0.5 dB mod. with signal No. 3 CCIR, from 10% to 85% in frequency range 1 to 5 MHz.
 $\pm 1^\circ$ maximum.
 -40 dB pp below black to white transition.
 2t 2%, 20t 3% or better.
 0.5 to 4.5 MHz: ± 50 ns
 4.5 to 4.8 MHz: ± 100 ns
 (measured with Nyquist demodulator meeting ARD specifications).
 75 ohm, terminated.
 -20 dB.

-10° to +60° C.
 0 to 95% relative humidity.
 Sea level to 3000 meters.
 61 cm W x 55.9 cm D x 13.3 cm H. Weight: 17.3 kg.
 105-125 VAC or 210-250 VAC, 50/60 Hz. Power consumption: 150 VA maximum.

¹ After initial aging of 60 days.

² Measured at 10% and 90% APL relative to response at 50% APL.

³ Maximum variation of sub-carrier amplitude from 75% to 10% of mod. Sub-carrier mod. percentage: 10% peak to peak.

⁴ Maximum variation of sub-carrier phase with respect to burst for mod. percentage from 75% to 10%. Sub-carrier mod. percentage: 10% peak to peak.

⁵ -30 dB or better return loss up to 5.0 MHz.

⁶ The MCP-1V Exciter does not provide sufficient selectivity in the exciter alone to meet FCC and CCIR transmitter specifications for -3.58 MHz suppression or harmonic radiation. However, when the MCP-1V is used in a Harris IF modulated transmitter, FCC and CCIR performance requirements in these areas will be met or exceeded.

ORDERING INFORMATION

MCP-1V visual exciter/modulator for FCC standards service, Channels 2-6	994-7861-002
MCP-1V retrofit visual exciter/modulator for FCC standards service, Channels 2-6	994-8136-001
MCP-1V visual exciter/modulator for FCC standards service, Channels 7-13	994-7861-003
MCP-1V retrofit visual exciter/modulator for FCC standards service, Channels 7-13	994-8135-001
MCP-1V visual exciter/modulator for CCIR System "B" service, Band I (54-68 MHz)	994-7861-005
MCP-1V visual exciter/modulator for CCIR System "B" service, Band III (174-223 MHz)	994-7861-006
Precise Frequency Control (optional)	994-6760-001
Phase Corrector PC Board (optional)	992-4717-001
Gain Corrector PC Board (optional)	992-4718-001
Automatic Exciter/Modulator Switcher (optional)	994-7016-001
RAK-96 basic rack (24") for mounting backup exciter, automatic exciter switcher	448-0636-000
Side panel kit for RAK-96. Includes two panels in Harris' white finish	448-0589-000
Front trim kit for RAK-96. Trim in brushed aluminum with Harris' blue insert	448-0637-000
Door handle with lock for rear door of RAK-96	448-0559-000



HARRIS

Series "E"

TVE-110

110-Kilowatt UHF
Color Television
Transmitter

- Variable Visual Coupler for higher klystron efficiency
- Advanced new SAW filter—built-in receiver equalizer eliminates separate correction modules
- New Quadrature Corrector cancels klystron distortions
- High efficiency 5-cavity klystrons
- Highly linear IF Modulation of the visual and aural carriers for superior color and sound reproduction
- Mod Anode Pulser for increased transmitter efficiency
- Straightforward design for high stability, reliability
- Low-loss waveguide diplexer

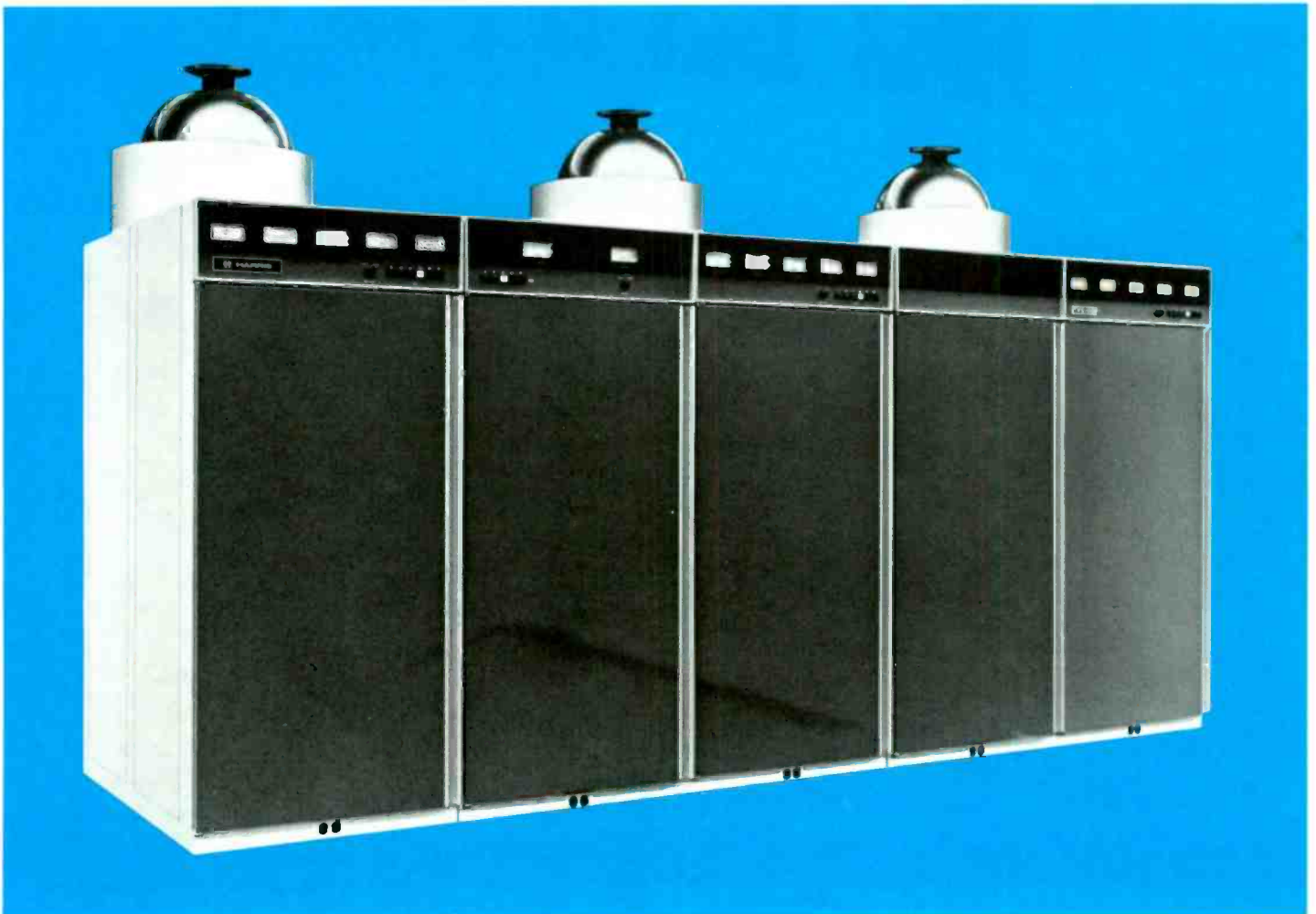

HARRIS' TVE-110—DESIGNED FOR TOP COLOR PERFORMANCE, ENERGY CONSERVATION



UNSURPASSED PERFORMANCE

The Harris TVE-110 is designed to meet the critical performance standards demanded by today's discriminating broadcaster. State-of-the-art technology, such as Harris' VIDEO* SAW receiver equalized filter and the Quadrature Corrector, is used to provide the highest levels of performance, reliability and stability. This performance level assures standard and subscription television broadcasters the best quality picture and sound, now and in the future.

SIGNIFICANT REDUCTION IN POWER CONSUMPTION

The TVE-110 transmitter includes a newly developed device that significantly reduces power consumption. This is the Variable Visual Coupler (VVC), which greatly increases the visual klystron's operating efficiency over previously used fixed couplers.

Several other energy-saving devices are also standard in the TVE-110, including "H" type

high-efficiency klystrons, the Mod Anode Pulser, and a high-efficiency aural klystron coupler.

For maximum efficiency, high power RF losses are kept to a minimum by using a waveguide visual combiner, a 100% waveguide diplexer and color notch filter.

KLYSTRONS

The three 5-cavity, vapor-cooled klystrons employed as visual and aural amplifiers in the TVE-110 are housed in separate cabinets containing identical control logic, magnetic supplies and overload sensors, and operate independently of one another.

"H" type high-efficiency integral-cavity klystrons are used. This type of klystron features high efficiency, easy tuning (only 5 adjustments), long life and no cavity maintenance.

The klystrons are mounted in special assemblies which pivot to allow easy installation or replacement by one man using the carriage provided.

MAXIMUM COLOR PERFORMANCE WITH MCP-2U EXCITERS

The MCP-2U visual exciter provides the television industry with the best color performance specifications ever offered in UHF-TV transmitting equipment. The advanced-design receiver equalized SAW vestigial sideband filter and the new Quadrature Corrector offer performance that exceeds even that of the industry standard Harris MCP-1U exciter.

Harris' new VIDEO SAW filter provides vestigial sideband shaping plus the required FCC group delay pre-correction. This new filter eliminates conventional receiver equalizers that require periodic maintenance with special test equipment. The equalized VIDEO SAW filter offers excellent performance year after year with absolutely no costly and time-consuming periodic realignment.

The precise equalization and the smooth, planar amplitude response of the new filter ensure a high degree of transparency to all types of video signals and test waveforms.

The MCP-2U visual exciter uses a new

and unique Quadrature Corrector that compensates for several types of klystron nonlinearities, such as differential gain, incidental phase and intermodulation distortions. This highly versatile corrector supplies the quality of transmitter performance that is required by modern receivers and subscription television decoders. Correction for incidental phase distortion reduces sync buzz and sync tip spikes, and also provides the low intercarrier noise performance that will be required for multi-channel TV sound in the future.

The MCP-2U is a completely self-contained unit that furnishes a fully processed on-channel picture signal. The unit contains an IF Modulator, vestigial sideband filter, up-converter, power supplies and all video and IF corrector circuits necessary to produce the on-channel signal.

The MCP-2U visual exciter is mounted in a pull-out drawer which offers quick access to all adjustments and modules for setup and troubleshooting.

The MCP aural exciter is also a solid-state self-contained unit which furnishes a fully processed aural signal at a level up to 0.5 watt. Power output can be set with a single knob on the front panel, or by remote control, with no need for retuning.

Highly linear direct FM modulation provides exceptional audio quality in today's transmitters. In addition, the wideband modulator is ready for tomorrow's multi-channel (stereo) sound.

A sub-carrier input is provided for telemetry or ENG communications.

MOD ANODE PULSER

The Mod Anode Pulser provides a means of operating high efficiency klystrons at reduced beam current during the video portion of the signal, and higher beam current only during sync. This feature provides a significant reduction in transmitter input power requirements.

HEAT EXCHANGER

The TVE-110 uses two high-capacity heat exchangers to cool the klystrons. Each heat exchanger is completely assembled and tested at the Harris factory, which permits quick and simple installation at the transmitter site.

A spare coolant pump is standard in each heat exchanger and may be brought on line without opening or closing any water valves.

Electrical power requirements for the heat exchangers are reduced by 25% because of more efficient electric motors. The high reserve capacity of the coils and pumps permits using a heat exchanger for dummy load water cooling without any extra cooling coils or other heat exchanger modifications or additions.

HV POWER SUPPLIES

The TVE-110 uses two identical HV power supplies. Using the HV patch panel provided with the transmitter, either power supply can be used to provide power to an aural and visual amplifier while the second power supply provides power to a visual amplifier. This capability insures that at least the aural klystron and one visual klystron will be in operation, even if one power supply should malfunction.

Each HV power supply, including transformer and solid-state rectifiers, is housed in a single assembly, mounted externally from the transmitter. Routine maintenance access is provided by a removable panel.

SOLID-STATE CONTROL LOGIC

Complete and foolproof control of all transmitter functions is achieved through the use of solid-state memory, timing and logic circuits. A self-charging emergency power source is provided to maintain control logic memory during periods of power line failure.

The solid-state control logic and protective circuitry, in addition to commanding normal AC control functions, is also used to visually indicate, through indicator lights, the operating status of the transmitter system. These indicator lights allow easy isolation of circuit faults.

AUTOMATIC RECYCLING

The TVE-110's built-in memory circuitry enables the entire transmitter to return to the air

automatically in the stage it was operating immediately prior to a partial or full power failure.

REMOTE CONTROL, UNATTENDED AND AUTOMATIC OPERATION

All control, metering and monitoring circuits have been designed specifically for remote control and unattended operation. The power controls are motor driven and the necessary remote control and parameter sampling points are built-in. Accessible terminal boards provide easy connections to remote control equipment. In addition, Harris' transmitter design is consistent with anticipated future automatic transmitter requirements.

EASE OF MAINTENANCE

Total transmitter component accessibility is provided. Visual and aural exciters slide out and can operate independently from the transmitter outside the exciter driver cabinet. Various exciter circuits such as oscillators, modulators and processing circuitry, are of modular construction and can be removed for maintenance or replacement.

TRANSMITTER CONFIGURATION

The TVE-110 consists of: a visual amplifier; a control cabinet containing exciters, plus splitting, phasing and balance networks; a second visual amplifier; a second control cabinet which can be used to mount optional spare exciters; and an aural amplifier. The transmitter has been built in a modular fashion so that cabinets may be separated into convenient, easy-to-handle sub-assemblies to facilitate installation.

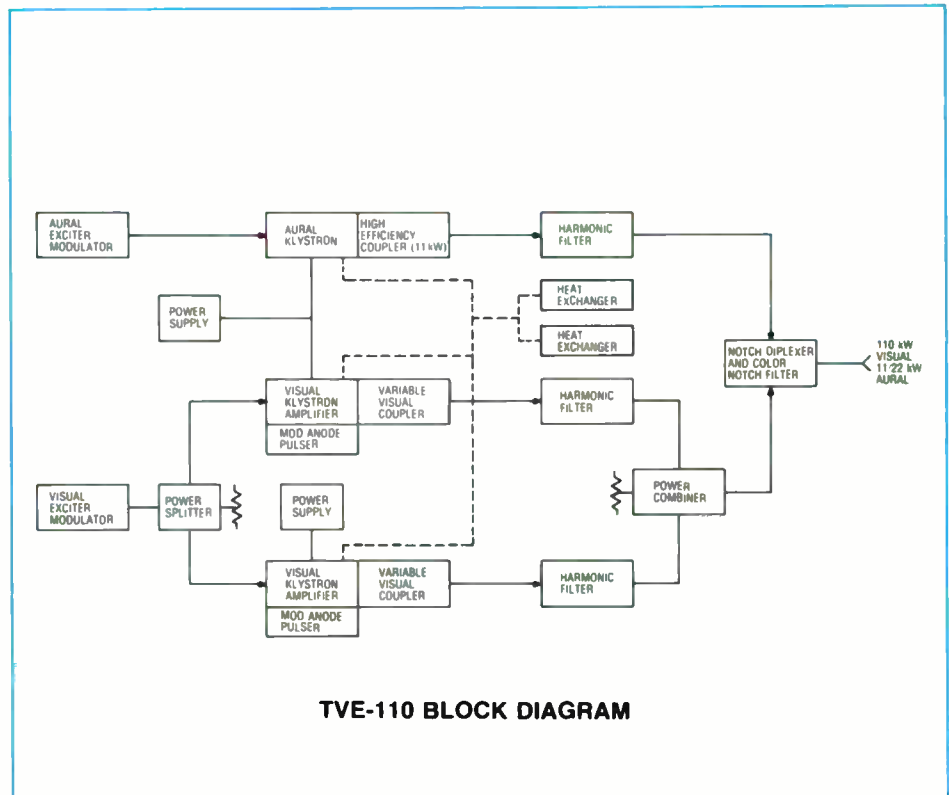

TVE-110 BLOCK DIAGRAM

TVE-110 SPECIFICATIONS

VISUAL PERFORMANCE

POWER OUTPUT:⁶
LOAD IMPEDANCE:

FREQUENCY RANGE:
FREQUENCY STABILITY:¹
REG. OF RF OUTPUT POWER (black to white pic.):
VARIATION OF OUTPUT (over one frame):
VISUAL SIDEBAND RESPONSE:^{2,6}

FREQUENCY RESPONSE VS. BRIGHTNESS:³
VISUAL MODULATION CAPABILITY:
DIFFERENTIAL GAIN:⁴
LINEARITY (LOW FREQUENCY):⁵
DIFFERENTIAL PHASE:⁴
INCIDENTAL PHASE:
SYNC OVERSHOOT:
SIGNAL TO NOISE RATIO:
K-FACTORS:
EQUIVALENT ENVELOPE DELAY:

VIDEO INPUT:
HARMONIC RADIATION:
AURAL PERFORMANCE
POWER OUTPUT:⁶

LOAD IMPEDANCE:
AUDIO INPUT:
FREQUENCY DEVIATION CAPABILITY:
INPUT IMPEDANCE:
PRE-EMPHASIS:
FREQUENCY RESPONSE:
DISTORTION:⁷
FM NOISE:⁷
INTERCARRIER PHASE MODULATION:
AM NOISE:
FREQUENCY STABILITY:⁸

SERVICE CONDITIONS
AMBIENT TEMPERATURE:
AMBIENT HUMIDITY RANGE:
ALTITUDE:
PHYSICAL AND MECHANICAL DIMENSIONS:

ELECTRICAL REQUIREMENTS:

SYSTEM M/NTSC

110 kW peak.
50 ohms. Harmonic filter output connector: 6¹/₈" EIA flanged. Diplexer output connector: EIA Waveguide WR1800 (Ch. 14-19); WR1500 (Ch. 20-47); WR1150 (Ch. 48-69).
470-806 MHz (Channels 14-69).
- 500 Hz (maximum variation over 30 days).

Less than 2%.
Less than 2%.
3.58 MHz -42 dB or better
- 1.25 MHz and lower -20 dB or better
- 0.75 MHz to + 3.58 MHz ± 0.5 dB
- 4.18 MHz 0 to -2 dB
+ 4.5 MHz -35 dB
+ 4.75 MHz and higher -40 dB or better
- 0.75 dB.

0%.
0.5 dB or better.
1.0 dB or better.
± 3°.
± 2° or better relative to blanking.
5% or less of sync peak within ± 300 ns of leading trailing edge.
- 50 dB (RMS) or better below sync level.
2T 2%, 20T less than 5% baseline disturbance.
0.5 to 2.1 MHz: - 40 ns
at 3.58 MHz: - 25 ns
at 4.18 MHz: - 60 ns
(referenced to standard curve-FCC)
75 ohm, - 30 dB or better return loss up to 5.0 MHz.
- 80 dB.

22 kW at diplexer output (Ch. 14-51).
11 kW at diplexer output (Ch. 52-69).
50 ohms. Cabinet output connector: 6¹/₈" EIA unflanged (Ch. 14-51). 3¹/₈" EIA flanged (Ch. 52-69).
- 10 dBm. ± 2 dB.
- 50 kHz.
600 ohms.
75 microseconds.
- 0.5 dB rel. to pre-emphasis (30-15,000 Hz).
0.5% THD or less with ± 25 kHz deviation.
- 59 dB or better rel. to ± 25 kHz dev.
- 46 dB RMS or better rel. to ± 25 kHz dev.
- 55 dB relative to 100% modulation.
- 20 Hz.

+ 2° C to + 50 C (36 to 122 F).
0 to 95% relative humidity.
Sea level to 7,500 feet (2286 meters).
157¹/₂" W x 63" D x 72" H (400 cm W x 160 cm D x 183 cm H). Note: hoods and steam weirs are higher than cabinet (height varies with channel). Approximate weight: 6500 lbs. (2948 kg.).
Power supplies (2): each 73³/₄" W x 52" D x 53³/₄" H (187 cm W x 132 cm D x 137 cm H). Approx. weight 7750 lbs. (3515 kg.).
Heat exchangers (2): each 96" W x 48" D x 78" H. (plus ducting). (244 cm W x 122 cm D x 198 cm H). Approx. weight 4000 lbs. (1816 kg.).
Power input: 440 460 480 volts, 3 phase, 60 Hz. Power consumption (typical): 288 kW (10% aural); 328 kW (20% aural). Power factor: better than 90%.

SPECIFICATIONS SUBJECT TO CHANGE WITHOUT NOTICE.

¹ After initial aging of 60 days.
² Response specified for transmitter operating into a resistive load of 1.05 VSWR or better.
³ Measured using 20% p p amplitude swept video modulation with pedestal set at black 10%, white 90% with reference to grey level 50%. All percentages relative to blanking to white excursion
⁴ Measured with 5-step riser signal from 75% to 12.5% of sync peak. Sub-carrier mod. percentage 12.5% peak to peak.
⁵ Measured with a 5-step riser signal.
⁶ Measured at output of Harris supplied diplexer.
⁷ After de-emphasis
⁸ Relative to frequency offset of 4.5 MHz

ORDERING INFORMATION

TVE-110, 110 kW UHF-TV transmitter for FCC standards service, Channels 14-69, with semiconductors, crystals, VSB filter, harmonic and color notch filters, Mod Anode Pulser, Variable Visual Coupler, notch diplexer 994-8723-001



HARRIS

Series "E"

TVE-55

55-Kilowatt UHF
Color Television
Transmitter

- Variable Visual Coupler for higher klystron efficiency
- Advanced new SAW filter—built-in receiver equalizer eliminates separate correction modules
- New Quadrature Corrector cancels klystron distortions
- High efficiency 5-cavity klystrons
- Highly linear IF Modulation of the visual and aural carriers for superior color and sound reproduction
- Mod Anode Pulser for increased transmitter efficiency
- Straightforward design for high stability, reliability
- Low-loss waveguide diplexer
- Emergency multiplex operation minimizes off-air time

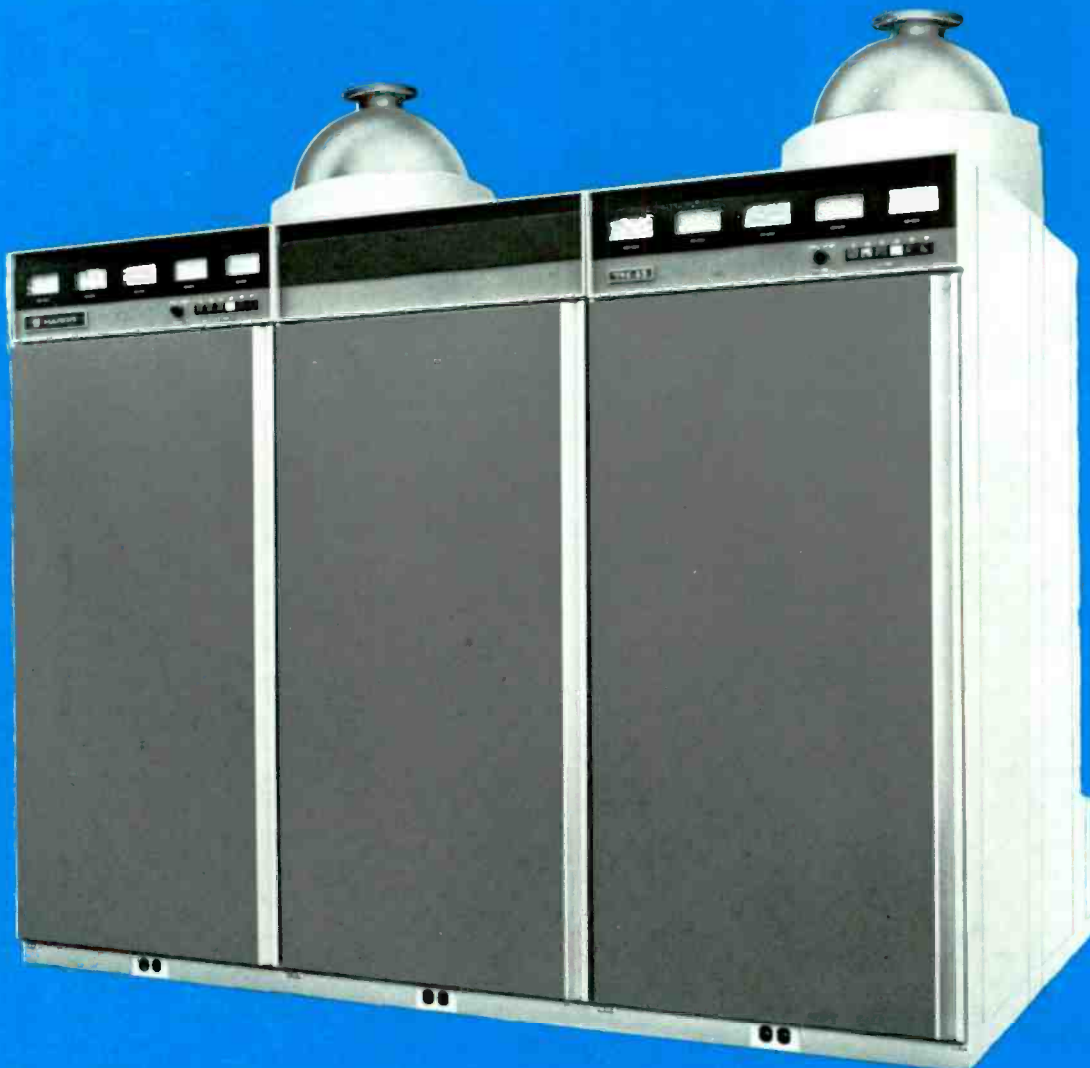

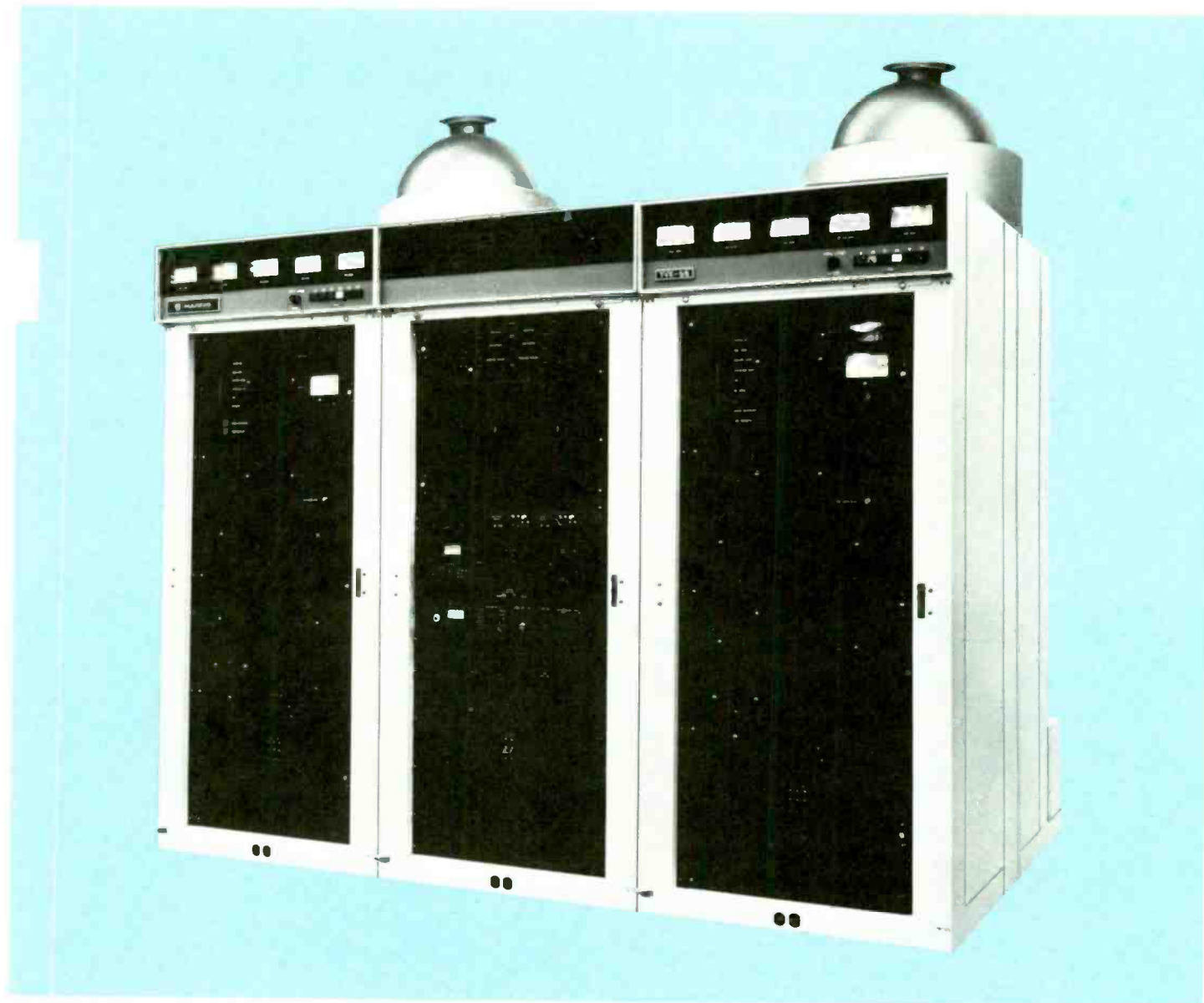

UNSURPASSED PERFORMANCE

The Harris TVE-55 is designed to meet the critical performance standards demanded by today's discriminating broadcaster. State-of-the-art technology, such as Harris' VIDEO* SAW receiver equalized filter and the Quadrature Corrector, is used to provide the highest levels of performance, reliability and stability. This performance level assures standard and subscription television broadcasters the best quality picture and sound, now and in the future.

SIGNIFICANT REDUCTION IN POWER CONSUMPTION

The TVE-55 transmitter includes a newly developed device that significantly reduces power consumption. This is the Variable Visual Coupler (VVC), which greatly increases the visual klystron's operating efficiency over previously used fixed couplers.

Several other energy-saving devices are also

standard in the TVE-55, including "H" type high-efficiency klystrons, the Mod Anode Pulser, and a high-efficiency aural klystron coupler.

For maximum efficiency, high power RF losses are kept to a minimum by using a 100% waveguide diplexer and color notch filter.

KLYSTRONS

The two 5-cavity, vapor-cooled klystrons employed as visual and aural amplifiers in the TVE-55 are housed in separate cabinets containing identical control logic, magnet supplies and overload sensors, and operate independently of one another.

"H" type high-efficiency integral-cavity klystrons are used. This type of klystron features high efficiency, easy tuning (only 5 adjustments), long life and no cavity maintenance.

The klystrons are mounted in special assemblies which pivot to allow easy installation

or replacement by one man using the carriage provided.

MAXIMUM COLOR PERFORMANCE WITH MCP-2U EXCITERS

The MCP-2U visual exciter provides the television industry with the best color performance specifications ever offered in UHF-TV transmitting equipment. The advanced-design receiver equalized SAW vestigial sideband filter and the new Quadrature Corrector offer performance that exceeds even that of the industry standard Harris MCP-1U exciter.

Harris' new VIDEO SAW filter provides vestigial sideband shaping plus the required FCC group delay pre-correction. This new filter eliminates conventional receiver equalizers that require periodic maintenance with special test equipment. The equalized VIDEO SAW filter offers excellent performance year after year with absolutely no costly and time-consuming periodic realignment.

The precise equalization and the smooth, pla-

nar amplitude response of the new filter insure a high degree of transparency to all types of video signals and test waveforms.

The MCP-2U visual exciter uses a new and unique Quadrature Corrector that compensates for several types of klystron nonlinearities, such as differential gain, incidental phase and intermodulation distortions. This highly versatile corrector supplies the quality of transmitter performance that is required by modern receivers and subscription television decoders. Correction for incidental phase distortion reduces sync buzz and sync tip spikes, and also provides the low intercarrier noise performance that will be required for multi-channel TV sound in the future.

The MCP-2U is a completely self-contained unit that furnishes a fully processed on-channel picture signal. The unit contains an IF Modulator, vestigial sideband (SAW) filter, up-converter, power supplies and all video and IF corrector circuits necessary to produce the on-channel signal.

The MCP-2U visual exciter is mounted in a pull-out drawer which offers quick access to all adjustments and modules for setup and troubleshooting.

The MCP aural exciter is also a solid-state self-contained unit which furnishes a fully processed aural signal at a level up to 0.5 watt. Power output can be set with a single knob on the front panel, or by remote control, with no need for retuning.

Highly linear direct FM modulation provides exceptional audio quality in today's transmitters. In addition, the wideband modulator is ready for tomorrow's multi-channel (stereo) sound.

A sub-carrier input is provided for telemetry or ENG communications.

MOD ANODE PULSER

The Mod Anode Pulser provides a means of operating high efficiency klystrons at reduced beam current during the video portion of the signal, and higher beam current only during sync. This feature provides a significant reduction in transmitter input power requirements.

HEAT EXCHANGER

The TVE-55 uses one high-capacity heat exchanger to cool both klystrons. The heat exchanger is completely assembled and tested at the Harris factory, which permits quick and simple installation at the transmitter site.

A spare coolant pump is standard in the heat exchanger and may be brought on line without opening or closing any water valves.

Electrical power requirements for the heat exchanger are reduced by 25% because of more efficient electric motors. The high reserve ca-

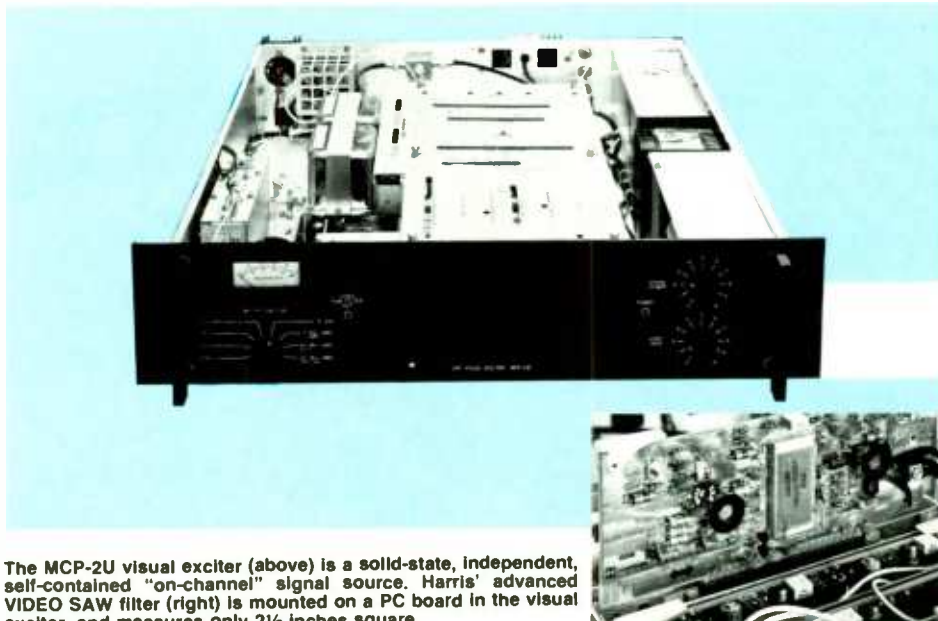

The MCP-2U visual exciter (above) is a solid-state, independent, self-contained "on-channel" signal source. Harris' advanced VIDEO SAW filter (right) is mounted on a PC board in the visual exciter, and measures only 2½ inches square.

capacity of the coils and pumps permits using the heat exchanger for dummy load water cooling without any extra cooling coils or other heat exchanger modifications or additions.

HV POWER SUPPLY

The HV power supply, including transformer and solid-state rectifiers, is housed in a single assembly, mounted externally to the transmitter. Routine maintenance access is provided by a removable panel.

EMERGENCY MULTIPLEX OPERATION

Every TVE-55 transmitter is equipped to permit combined (multiplex) amplification of the aural and visual signals through the visual klystron. This feature reduces off-air time in the event of a klystron failure. The seven-port patch panel employed to bypass the notch diplexer during multiplex operation also permits connecting the diplexer output or either klystron's output directly to a dummy load.

SOLID-STATE CONTROL LOGIC

Complete and foolproof control of all transmitter functions is achieved through the use of solid-state memory, timing and logic circuits. A self-charging emergency power source is provided to maintain control logic memory during periods of power line failure.

AUTOMATIC RECYCLING

The TVE-55's built-in memory circuitry enables the entire transmitter to return to the air automatically in the state it was operating immediately prior to a partial or full power failure.

REMOTE CONTROL, UNATTENDED AND AUTOMATIC OPERATION

All control, metering and monitoring circuits have been designed specifically for remote control and automatic operation. The power controls are motor driven and the necessary

remote control and parameter sampling points are built-in. Accessible terminal boards provide easy connections to remote control equipment.

Today, Harris TV transmitters are being operated successfully worldwide with and without remote control. In addition, Harris' transmitter design is consistent with anticipated future automatic transmitter requirements.

IF MODULATION

One of the important features of the TVE-55 is its true low-level IF Modulation, which provides a top quality picture, and excels in electrical performance, reliability, and simplicity of operation.

In the TVE-55, the visual and aural exciters generate fully modulated low-level IF signals. The output of a common crystal controlled reference oscillator is used to raise the individual IF signal to the desired "on channel" output frequency.

Due to the low-level techniques, which include the use of devices such as an extremely linear broadband diode ring modulator, low-level sideband filtering and very linear broadband amplifiers, the broadcast signal is a faithful reproduction of the signal applied to the transmitter input. The IF corrections for amplitude and phase distortions are necessary to correct for klystron distortions only, since signal generation and amplification at low levels are practically distortion free.

EASE OF MAINTENANCE AND INSTALLATION

Total transmitter component accessibility is provided. Visual and aural exciters slide out and can operate independently from the transmitter outside the exciter/driver cabinet. Various exciter circuits such as oscillators, modulators and processing circuitry, are of modu-

lar construction and can be removed for maintenance or replacement.

Easy-to-read, eye-level 4-inch meters are used to monitor required transmitter functions. Meter panels are of double-hinged construction for convenient access during maintenance. A complete system of overload indicators is also provided in each cabinet for monitoring transmitter operation. In the event of a transmitter malfunction, an examination of the indicators will locate the problem area.

A calorimeter kit is included with each transmitter for accurate power measurement and meter calibration.

The transmitter has been built in a modular fashion so that cabinets may be separated into convenient, easy-to-handle sub-assemblies to facilitate installation. Additionally, the compact design of the TVE-55 minimizes space requirements in the transmitter building.



The Variable Visual Coupler employed in the TVE-55 greatly increases the visual klystron's efficiency over the previously used fixed couplers.



TVE-55, rear view. (Inset) Mod Anode Pulser.

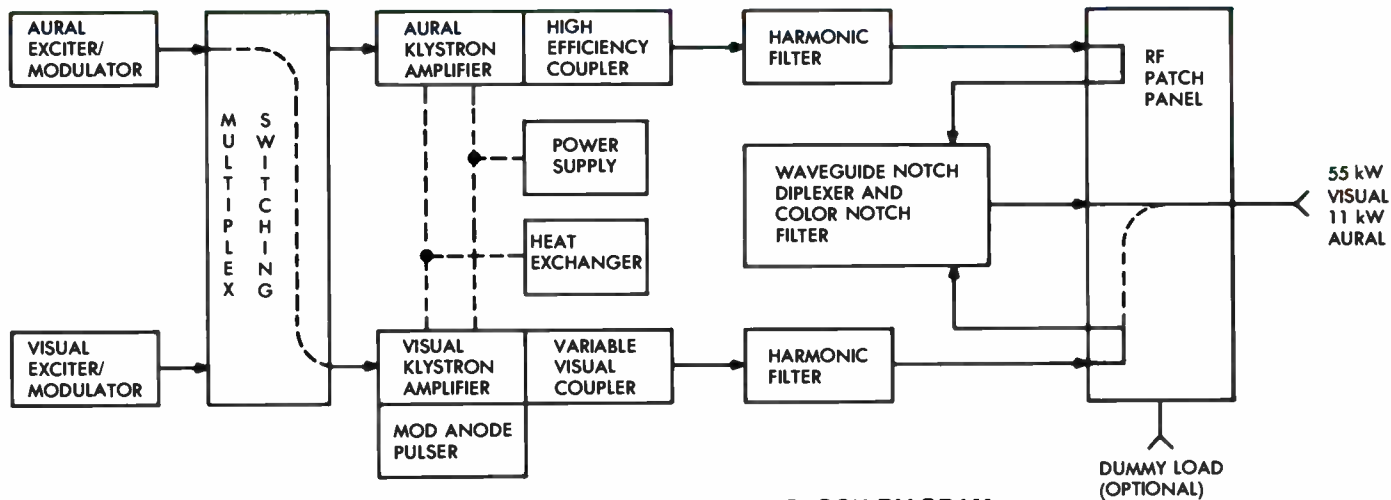

TVE-55 BLOCK DIAGRAM

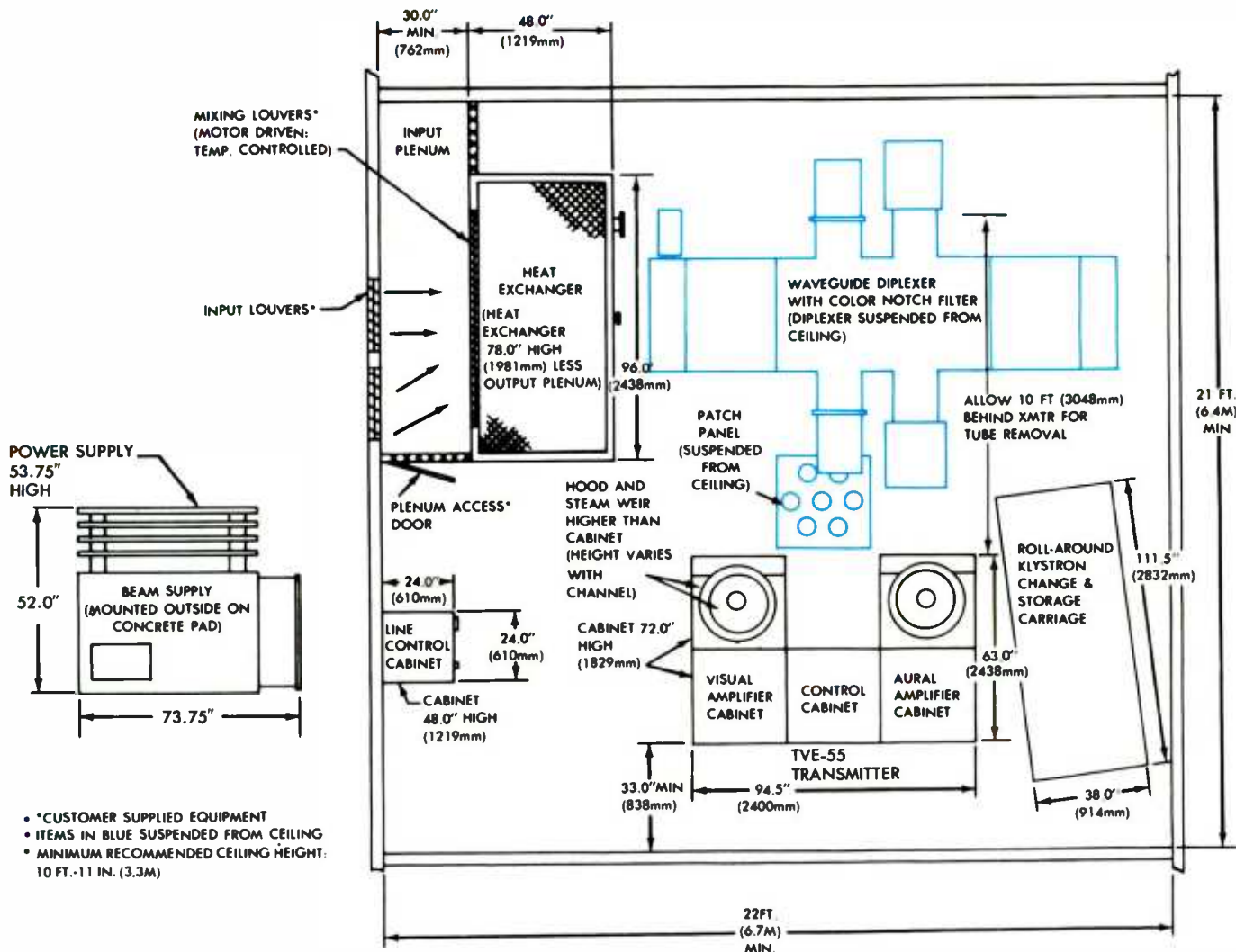

- *CUSTOMER SUPPLIED EQUIPMENT
- ITEMS IN BLUE SUSPENDED FROM CEILING
- MINIMUM RECOMMENDED CEILING HEIGHT: 10 FT.-11 IN. (3.3M)

TYPICAL EQUIPMENT PLACEMENT TVE-55 TRANSMITTER

TVE-55 SPECIFICATIONS

VISUAL PERFORMANCE

POWER OUTPUT:⁶
LOAD IMPEDANCE:

FREQUENCY RANGE:
FREQUENCY STABILITY:¹
REG. OF RF OUTPUT POWER (black to white plc.):
VARIATION OF OUTPUT (over one frame):
VISUAL SIDEBAND RESPONSE:^{2,6}

FREQUENCY RESPONSE VS. BRIGHTNESS:³

VISUAL MODULATION CAPABILITY:

DIFFERENTIAL GAIN:⁴
LINEARITY (LOW FREQUENCY):⁵
DIFFERENTIAL PHASE:⁴

INCIDENTAL PHASE:
SYNC OVERTHOOT:
SIGNAL TO NOISE RATIO:
K-FACTORS:
EQUIVALENT ENVELOPE DELAY:

VIDEO INPUT:

HARMONIC RADIATION:

AURAL PERFORMANCE

POWER OUTPUT:⁶

LOAD IMPEDANCE:

AUDIO INPUT:

FREQUENCY DEVIATION CAPABILITY:

INPUT IMPEDANCE:

PRE-EMPHASIS:

FREQUENCY RESPONSE:

DISTORTION:⁷

FM NOISE:⁷

INTERCARRIER PHASE MODULATION:

AM NOISE:

FREQUENCY STABILITY:⁸

SERVICE CONDITIONS

AMBIENT TEMPERATURE:

AMBIENT HUMIDITY RANGE:

ALTITUDE:

PHYSICAL AND MECHANICAL DIMENSIONS:

ELECTRICAL REQUIREMENTS:

SYSTEM M/NTSC

55 kW peak.

50 ohms. Cabinet output connector: 3/8" EIA flanged, (Channels 14-51); 6/8" EIA flanged, (Channels 52-69). Diplexer output connector: 6/8" EIA flanged.

470-806 MHz (Channels 14-69).

± 500 Hz (maximum variation over 30 days).

Less than 2%.

Less than 2%.

- 3.58 MHz	- 42 dB or better
- 1.25 MHz and lower	- 20 dB or better
- 0.75 MHz to + 3.58 MHz	± 0.5 dB
+ 4.18 MHz	0 to - 2 dB
+ 4.5 MHz	- 35 dB
+ 4.75 MHz and higher	- 40 dB or better
± 0.75 dB.	

0%.

0.5 dB or better.

1.0 dB or better.

± 3°.

± 2° or better relative to blanking.

5% or less of sync peak within ± 300 ns of leading/trailing edge.

- 50 dB (RMS) or better below sync level.

2T 2%, 20T less than 5% baseline disturbance.

0.5 to 2.1 MHz ± 40 ns

at 3.58 MHz ± 25 ns

at 4.18 MHz ± 60 ns

(referenced to standard curve-FCC)

75 ohm, - 30 dB or better return loss up to 5.0 MHz.

- 80 dB.

11 kW.

50 ohms. Cabinet output connector: 3/8" EIA unflanged.

+ 10 dBm, ± 2 dB.

± 50 kHz.

600 ohms.

75 microseconds.

± 0.5 dB rel. to pre-emphasis (30-15,000 Hz).

0.5% THD or less with ± 25 kHz deviation.

- 59 dB or better rel. to ± 25 kHz dev.

- 46 dB RMS or better rel. to ± 25 kHz dev.

- 55 dB relative to 100% modulation.

± 20 Hz.

+ 2° C to + 50° C (36° to 122° F).

0 to 95% relative humidity.

Sea level to 7,500 feet (2286 meters).

94" W x 63" D x 72" H (240 cm W x 160 cm D x 183 cm H). Weight: 4100 lbs. (1864 kg.). Power supply: 73 3/4" W x 52" D x 53 3/4" H (187 cm W x 132 cm D x 137 cm H). Weight: 7750 lbs. (3515 kg.). Heat exchanger: 96" W x 48" D x 78" H (244 cm W x 122 cm D x 198 cm H). Weight: 4000 lbs. (1816 kg.).

Power input: 440/460/480 volts, 3 phase, 60 Hz. Power consumption (typical): 145 kW (10% aural); 163 kW (20% aural). Power factor: better than 90%.

SPECIFICATIONS SUBJECT TO CHANGE WITHOUT NOTICE.

¹ After initial aging of 60 days.

² Response specified for transmitter operating into a resistive load of 1.05 VSWR or better.

³ Measured using 20% p.p. amplitude swept video modulation with pedestal set at black 10%, white 90% with reference to grey level 50%. All percentages relative to blanking to white excursion.

⁴ Measured with 5-step riser signal from 75% to 12.5% of sync peak. Sub-carrier mod. percentage 12.5% peak to peak.

⁵ Measured with a 5-step riser signal.

⁶ Measured at output of Harris supplied diplexer.

⁷ After de-emphasis.

⁸ Relative to frequency offset of 4.5 MHz.

ORDERING INFORMATION

TVE-55, 55 kW UHF-TV transmitter for FCC standards service, Channels 14-69, with semiconductors, crystals, VSB filter, harmonic and color notch filters, Mod Anode Pulsar, Variable Visual Coupler, notch diplexer 994-8722-001



HARRIS

Series "E"

TVE-30

30-Kilowatt UHF
Color Television
Transmitter

- Variable Visual Coupler for higher klystron efficiency
- Advanced new SAW filter—built-in receiver equalizer eliminates separate correction modules
- New Quadrature Corrector cancels klystron distortions
- High efficiency 5-cavity klystrons
- Highly linear IF Modulation of the visual and aural carriers for superior color and sound reproduction
- Mod Anode Pulser for increased transmitter efficiency
- Straightforward design for high stability, reliability
- Low-loss waveguide diplexer
- Emergency multiplex operation minimizes off-air time

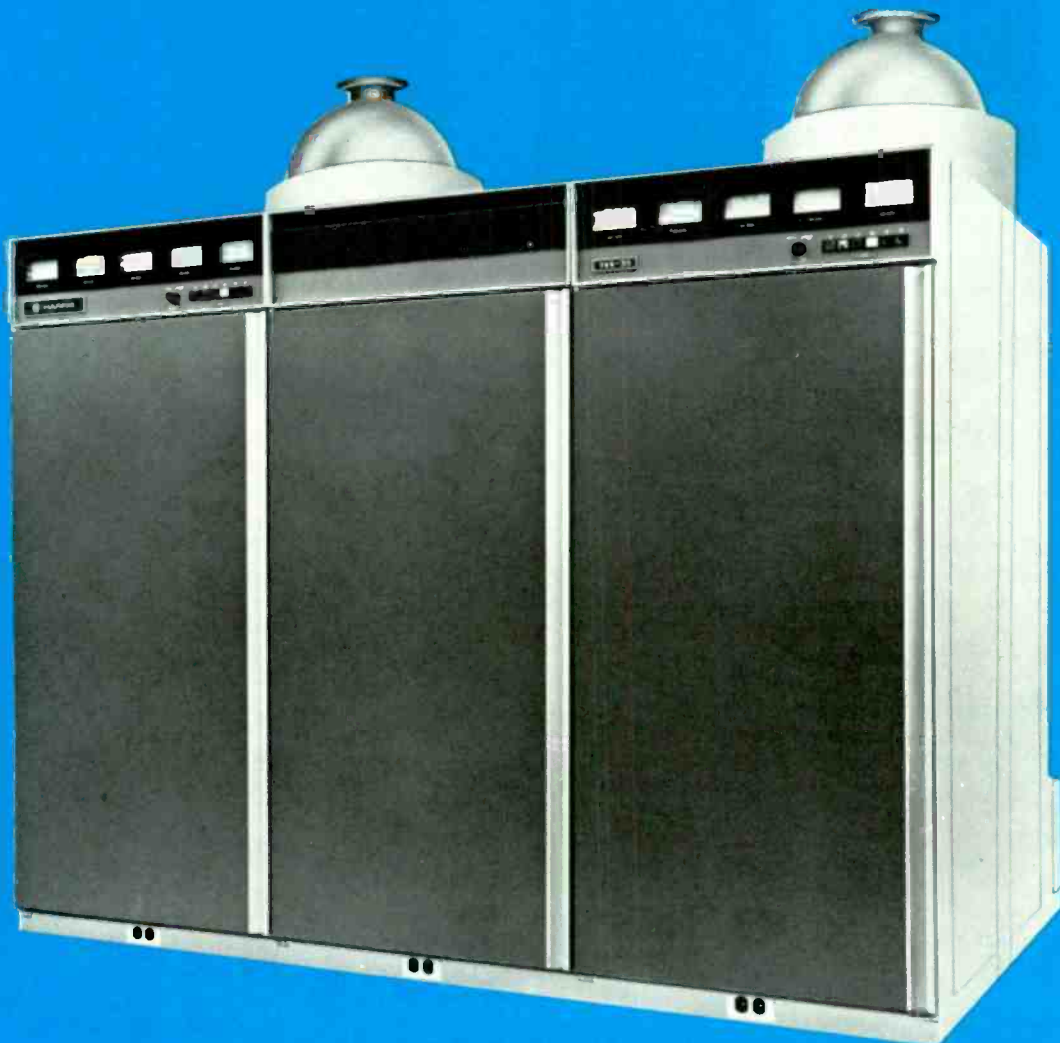

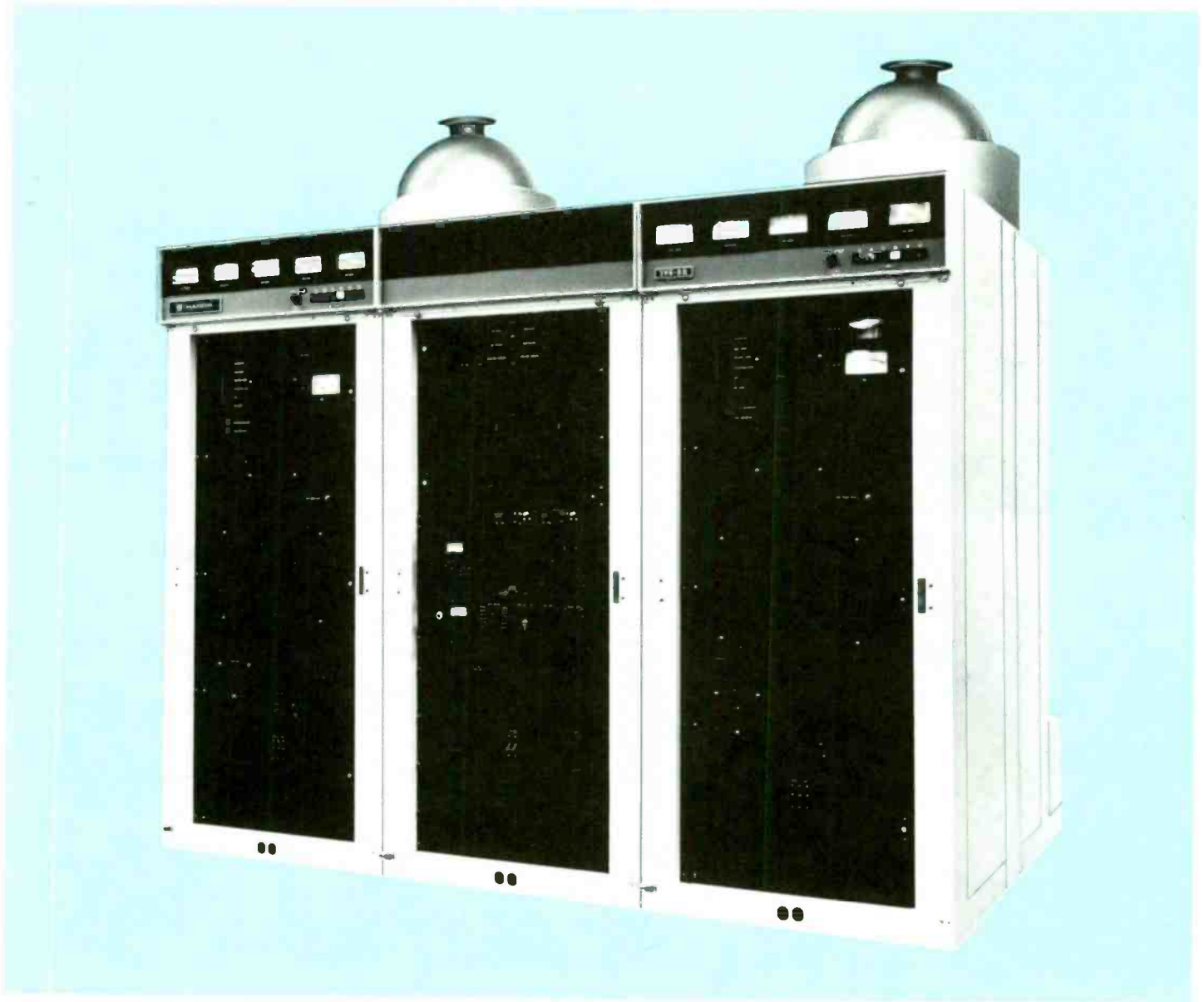

UNSURPASSED PERFORMANCE

The Harris TVE-30 is designed to meet the critical performance standards demanded by today's discriminating broadcaster. State-of-the-art technology, such as Harris' VIDEO* SAW receiver equalized filter and the Quadrature Corrector, is used to provide the highest levels of performance, reliability and stability. This performance level assures standard and subscription television broadcasters the best quality picture and sound, now and in the future.

SIGNIFICANT REDUCTION IN POWER CONSUMPTION

The TVE-30 transmitter includes a newly developed device that significantly reduces power consumption. This is the Variable Visual Coupler (VVC), which greatly increases the visual klystron's operating efficiency over previously used fixed couplers.

Several other energy-saving devices are also

*Visual IF Delay Equalized Output

standard in the TVE-30, including "H" type high-efficiency klystrons, the Mod Anode Pulser, and a high-efficiency aural klystron coupler.

For maximum efficiency, high power RF losses are kept to a minimum by using a 100% waveguide diplexer and color notch filter.

KLYSTRONS

The two 5-cavity, vapor-cooled klystrons employed as visual and aural amplifiers in the TVE-30 are housed in separate cabinets containing identical control logic, magnet supplies and overload sensors, and operate independently of one another.

"H" type high-efficiency integral-cavity klystrons are used. This type of klystron features high efficiency, easy tuning (only 5 adjustments), long life and no cavity maintenance.

The klystrons are mounted in special assemblies which pivot to allow easy installation

or replacement by one man using the carriage provided.

MAXIMUM COLOR PERFORMANCE WITH MCP-2U EXCITERS

The MCP-2U visual exciter provides the television industry with the best color performance specifications ever offered in UHF-TV transmitting equipment. The advanced-design receiver equalized SAW vestigial sideband filter and the new Quadrature Corrector offer performance that exceeds even that of the industry standard Harris MCP-1U exciter.

Harris' new VIDEO SAW filter provides vestigial sideband shaping plus the required FCC group delay pre-correction. This new filter eliminates conventional receiver equalizers that require periodic maintenance with special test equipment. The equalized VIDEO SAW filter offers excellent performance year after year with absolutely no costly and time-consuming periodic realignment.

The precise equalization and the smooth, pla-

nar amplitude response of the new filter insure a high degree of transparency to all types of video signals and test waveforms.

The MCP-2U visual exciter uses a new and unique Quadrature Corrector that compensates for several types of klystron nonlinearities, such as differential gain, incidental phase and intermodulation distortions. This highly versatile corrector supplies the quality of transmitter performance that is required by modern receivers and subscription television decoders. Correction for incidental phase distortion reduces sync buzz and sync tip spikes, and also provides the low intercarrier noise performance that will be required for multi-channel TV sound in the future.

The MCP-2U is a completely self-contained unit that furnishes a fully processed on-channel picture signal. The unit contains an IF Modulator, vestigial sideband (SAW) filter, up-converter, power supplies and all video and IF corrector circuits necessary to produce the on-channel signal.

The MCP-2U visual exciter is mounted in a pull-out drawer which offers quick access to all adjustments and modules for setup and troubleshooting.

The MCP aural exciter is also a solid-state self-contained unit which furnishes a fully processed aural signal at a level up to 0.5 watt. Power output can be set with a single knob on the front panel, or by remote control, with no need for retuning.

Highly linear direct FM modulation provides exceptional audio quality in today's transmitters. In addition, the wideband modulator is ready for tomorrow's multi-channel (stereo) sound.

A sub-carrier input is provided for telemetry or ENG communications.

MOD ANODE PULSER

The Mod Anode Pulser provides a means of operating high efficiency klystrons at reduced beam current during the video portion of the signal, and higher beam current only during sync. This feature provides a significant reduction in transmitter input power requirements.

HEAT EXCHANGER

The TVE-30 uses one high-capacity heat exchanger to cool both klystrons. The heat exchanger is completely assembled and tested at the Harris factory, which permits quick and simple installation at the transmitter site.

A spare coolant pump is standard in the heat exchanger and may be brought on line without opening or closing any water valves.

Electrical power requirements for the heat exchanger are reduced by 25% because of more efficient electric motors. The high reserve ca-

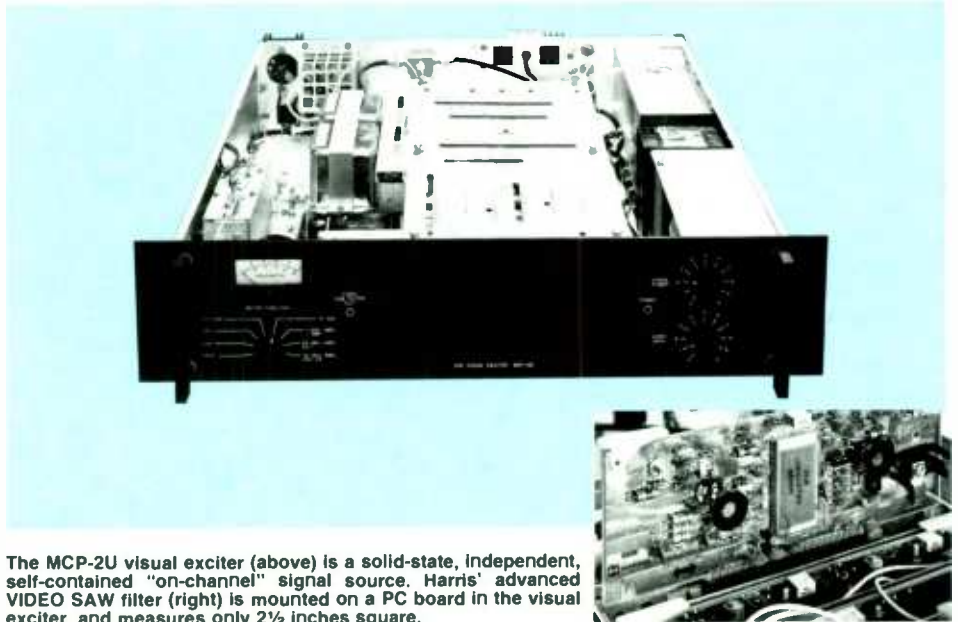

The MCP-2U visual exciter (above) is a solid-state, independent, self-contained "on-channel" signal source. Harris' advanced VIDEO SAW filter (right) is mounted on a PC board in the visual exciter, and measures only 2½ inches square.

capacity of the coils and pumps permits using the heat exchanger for dummy load water cooling without any extra cooling coils or other heat exchanger modifications or additions.

HV POWER SUPPLY

The HV power supply, including transformer and solid-state rectifiers, is housed in a single assembly, mounted externally to the transmitter. Routine maintenance access is provided by a removable panel.

EMERGENCY MULTIPLEX OPERATION

Every TVE-30 transmitter is equipped to permit combined (multiplex) amplification of the aural and visual signals through the visual klystron. This feature reduces off-air time in the event of a klystron failure. The seven-port patch panel employed to bypass the notch diplexer during multiplex operation also permits connecting the diplexer output or either klystron's output directly to a dummy load.

SOLID-STATE CONTROL LOGIC

Complete and foolproof control of all transmitter functions is achieved through the use of solid-state memory, timing and logic circuits. A self-charging emergency power source is provided to maintain control logic memory during periods of power line failure.

AUTOMATIC RECYCLING

The TVE-30's built-in memory circuitry enables the entire transmitter to return to the air automatically in the state it was operating immediately prior to a partial or full power failure.

REMOTE CONTROL, UNATTENDED AND AUTOMATIC OPERATION

All control, metering and monitoring circuits have been designed specifically for remote control and automatic operation. The power controls are motor driven and the necessary

remote control and parameter sampling points are built-in. Accessible terminal boards provide easy connections to remote control equipment.

Today, Harris TV transmitters are being operated successfully worldwide with and without remote control. In addition, Harris' transmitter design is consistent with anticipated future automatic transmitter requirements.

IF MODULATION

One of the important features of the TVE-30 is its true low-level IF Modulation, which provides a top quality picture, and excels in electrical performance, reliability, and simplicity of operation.

In the TVE-30, the visual and aural exciters generate fully modulated low-level IF signals. The output of a common crystal controlled reference oscillator is used to raise the individual IF signal to the desired "on channel" output frequency.

Due to the low-level techniques, which include the use of devices such as an extremely linear broadband diode ring modulator, low-level sideband filtering and very linear broadband amplifiers, the broadcast signal is a faithful reproduction of the signal applied to the transmitter input. The IF corrections for amplitude and phase distortions are necessary to correct for klystron distortions only, since signal generation and amplification at low levels are practically distortion free.

EASE OF MAINTENANCE AND INSTALLATION

Total transmitter component accessibility is provided. Visual and aural exciters slide out and can operate independently from the transmitter outside the exciter/driver cabinet. Various exciter circuits such as oscillators, modulators and processing circuitry, are of modu-

lar construction and can be removed for maintenance or replacement.

Easy-to-read, eye-level 4-inch meters are used to monitor required transmitter functions. Meter panels are of double-hinged construction for convenient access during maintenance. A complete system of overload indicators is also provided in each cabinet for monitoring transmitter operation. In the event of a transmitter malfunction, an examination of the indicators will locate the problem area.

A calorimeter kit is included with each transmitter for accurate power measurement and meter calibration.

The transmitter has been built in a modular fashion so that cabinets may be separated into convenient, easy-to-handle sub-assemblies to facilitate installation. Additionally, the compact design of the TVE-30 minimizes space requirements in the transmitter building.

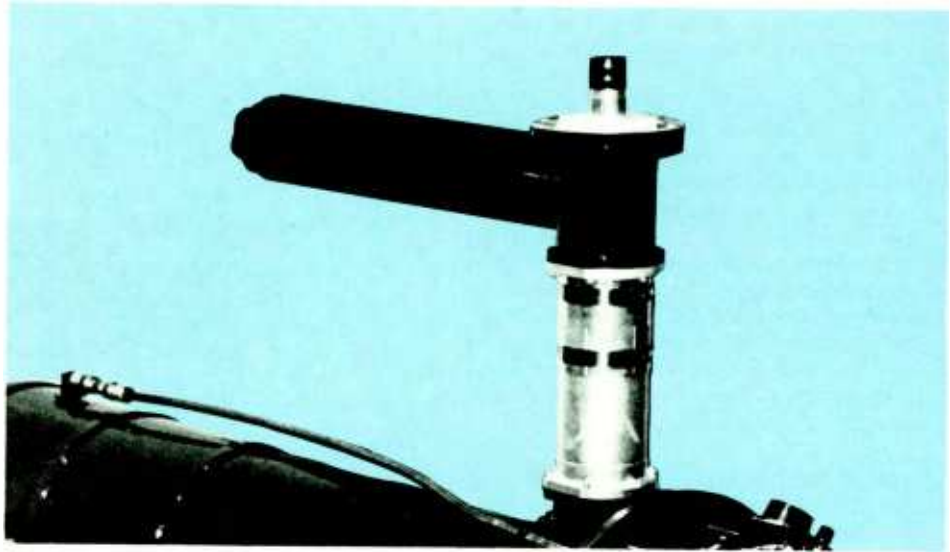

The Variable Visual Coupler employed in the TVE-30 greatly increases the visual klystron's efficiency over the previously used fixed couplers.



TVE-30, rear view. (Inset) Mod Anode Pulsar.

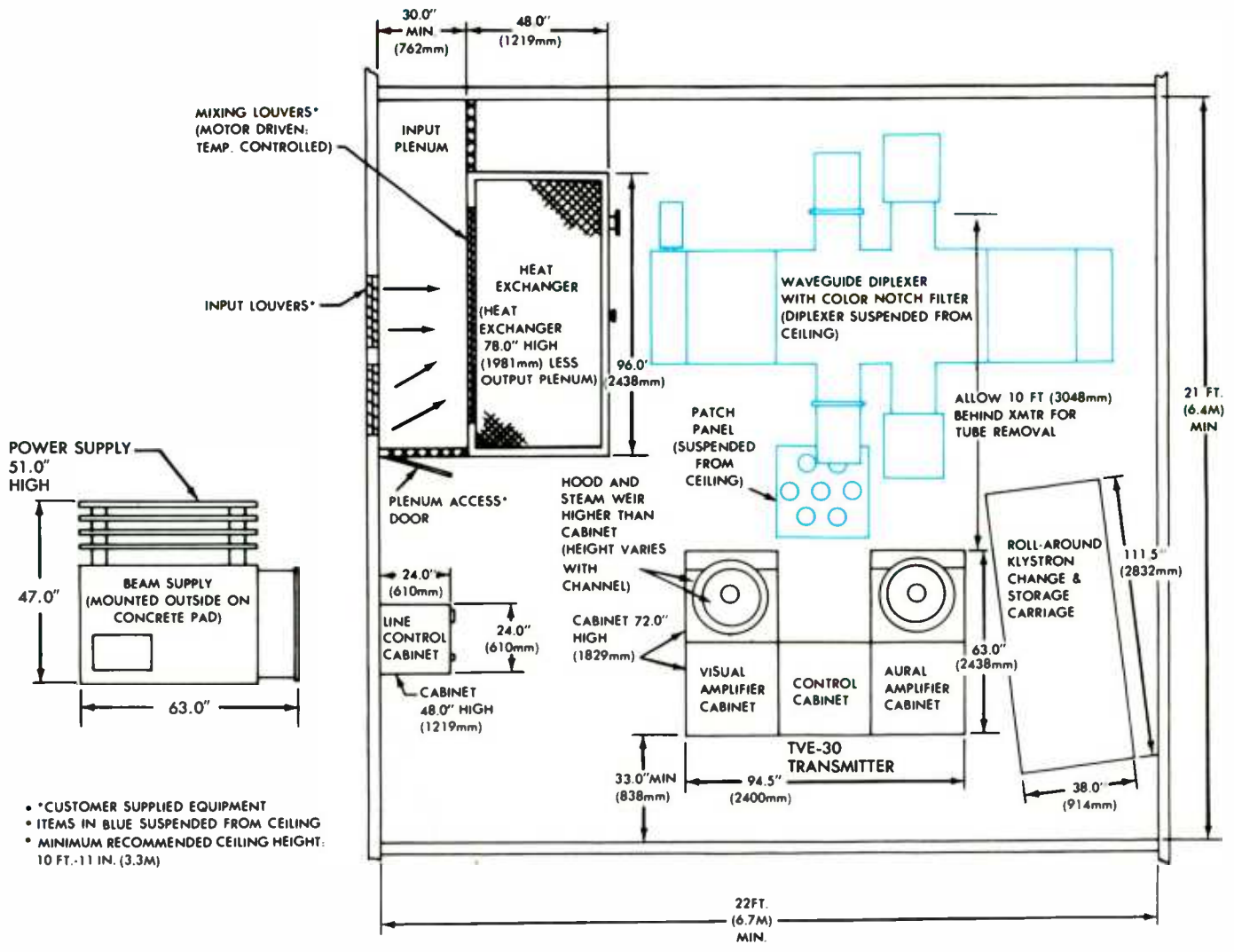
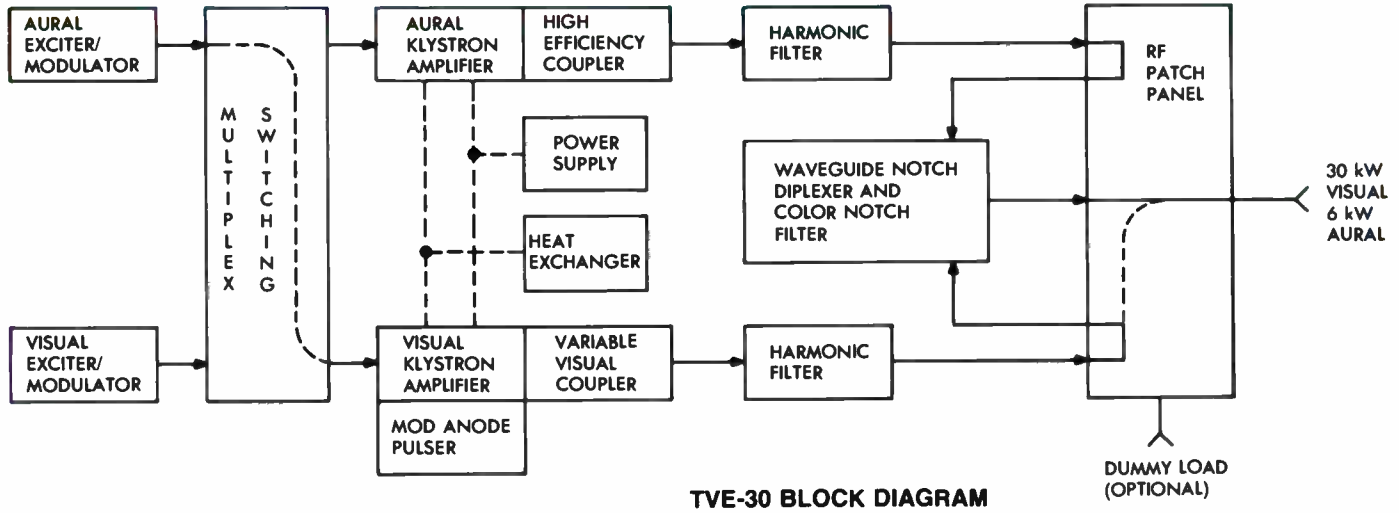

- *CUSTOMER SUPPLIED EQUIPMENT
- ITEMS IN BLUE SUSPENDED FROM CEILING
- * MINIMUM RECOMMENDED CEILING HEIGHT: 10 FT.-11 IN. (3.3M)

TYPICAL EQUIPMENT PLACEMENT TVE-30 TRANSMITTER

TVE-30 SPECIFICATIONS

VISUAL PERFORMANCE

POWER OUTPUT:⁶
LOAD IMPEDANCE:

FREQUENCY RANGE:
FREQUENCY STABILITY:¹
REG. OF RF OUTPUT POWER (black to white pic.):
VARIATION OF OUTPUT (over one frame):
VISUAL SIDEBAND RESPONSE:^{2,5}

FREQUENCY RESPONSE VS. BRIGHTNESS:³
VISUAL MODULATION CAPABILITY:
DIFFERENTIAL GAIN:⁴
LINEARITY (LOW FREQUENCY):⁵
DIFFERENTIAL PHASE:⁴
INCIDENTAL PHASE:
SYNC OVERSHOOT:
SIGNAL TO NOISE RATIO:
K-FACTORS:
EQUIVALENT ENVELOPE DELAY:

VIDEO INPUT:
HARMONIC RADIATION:
AURAL PERFORMANCE

POWER OUTPUT:⁶
LOAD IMPEDANCE:
AUDIO INPUT:
FREQUENCY DEVIATION CAPABILITY:
INPUT IMPEDANCE:
PRE-EMPHASIS:
FREQUENCY RESPONSE:
DISTORTION:⁷
FM NOISE:⁷
INTERCARRIER PHASE MODULATION:
AM NOISE:
FREQUENCY STABILITY:⁸

SERVICE CONDITIONS
AMBIENT TEMPERATURE:
AMBIENT HUMIDITY RANGE:
ALTITUDE:

PHYSICAL AND MECHANICAL DIMENSIONS:

ELECTRICAL REQUIREMENTS:

SYSTEM M/NTSC

30 kW peak.
 50 ohms. Cabinet output connector: 3/8" EIA flanged, (Channels 14-51); 6/16" EIA flanged, (Channels 52-69). Diplexer output connector: 6/16" EIA flanged.
 470-806 MHz (Channels 14-69).
 ± 500 Hz (maximum variation over 30 days).
 Less than 2%.
 Less than 2%.
 - 3.58 MHz - 42 dB or better
 - 1.25 MHz and lower - 20 dB or better
 - 0.75 MHz to + 3.58 MHz ± 0.5 dB
 + 4.18 MHz 0 to - 2 dB
 + 4.5 MHz - 35 dB
 + 4.75 MHz and higher - 40 dB or better
 ± 0.75 dB.
 0%.
 0.5 dB or better.
 1.0 dB or better.
 ± 3".
 ± 2° or better relative to blanking.
 5% or less of sync peak within ± 300 ns of leading/trailing edge.
 - 50 dB (RMS) or better below sync level.
 2T 2%, 20T less than 5% baseline disturbance.
 0.5 to 2.1 MHz ± 40 ns
 at 3.58 MHz ± 25 ns
 at 4.18 MHz ± 60 ns
 (referenced to standard curve-FCC)
 75 ohm, - 30 dB or better return loss up to 5.0 MHz.
 - 80 dB.

6 kW.
 50 ohms. Cabinet output connector: 3/8" EIA unflanged.
 + 10 dBm, ± 2 dB.
 ± 50 kHz.
 600 ohms.
 75 microseconds.
 ± 0.5 dB rel. to pre-emphasis (30-15,000 Hz).
 0.5% THD or less with ± 25 kHz deviation.
 - 59 dB or better rel. to ± 25 kHz dev.
 - 46 dB RMS or better rel. to ± 25 kHz dev.
 - 55 dB relative to 100% modulation.
 ± 20 Hz.

+ 2° C to + 50° C (36° to 122° F).
 0 to 95% relative humidity.
 Sea level to 7,500 feet (2286 meters).
 94" W x 63" D x 72" H (240 cm W x 160 cm D x 183 cm H). Weight: 4100 lbs. (1864 kg.). Power supply: 63" W x 47" D x 51" H (160 cm W x 119 cm D x 130 cm H). Weight: 4700 lbs. (2133 kg.). Heat exchanger: 96" W x 48" D x 78" H (244 cm W x 122 cm D x 198 cm H). Weight: 4000 lbs. (1816 kg.).
 Power input: 440/460/480 volts, 3 phase, 60 Hz. Power consumption (typical): 90 kW (10% aural); 99 kW (20% aural). Power factor: better than 90%.

SPECIFICATIONS SUBJECT TO CHANGE WITHOUT NOTICE.

- ¹ After initial aging of 60 days.
- ² Response specified for transmitter operating into a resistive load of 1.05 VSWR or better.
- ³ Measured using 20% p.p. amplitude swept video modulation with pedestal set at black 10%, white 90% with reference to gray level 50%. All percentages relative to blanking to white excursion.
- ⁴ Measured with 5-step riser signal from 75% to 12.5% of sync peak. Sub-carrier mod. percentage 12.5% peak to peak.
- ⁵ Measured with a 5-step riser signal.
- ⁶ Measured at output of Harris supplied diplexer.
- ⁷ After de-emphasis.
- ⁸ Relative to frequency offset of 4.5 MHz.

ORDERING INFORMATION

TVE-30, 30 kW UHF-TV transmitter for FCC standards service, Channels 14-69, with semiconductors, crystals, VSB filter, harmonic and color notch filters, Mod Anode Pulser, Variable Visual Coupler, notch diplexer 994-8721-001



MCP-2U UHF-TV Visual Exciter

- **Advanced SAW vestigial sideband filter with built-in receiver equalization provides superior frequency and group delay performance**
- **Quadrature Corrector effectively cancels klystron distortions**
- **Excellent video performance specifications**
- **Designed for easy serviceability through use of plug-in P.C. boards and roll-out exciter drawer**
- **Conservative circuit design and new SAW filter provide highly superior reliability and stability**

The MCP-2U visual exciter provides the television industry with the best color performance specifications ever offered in UHF-TV transmitting equipment. The receiver equalized surface acoustic wave (SAW) filter and the new Quadrature Corrector provide performance that exceeds even that of the industry standard Harris MCP-1U. The MCP-2U is another step in Harris' continuing use of high

technology to provide broadcasters with maximum color performance (MCP) and trouble-free, low-maintenance operation.

RECEIVER EQUALIZED SAW FILTER (System M Only)

Harris' new VIDEO* SAW filter provides vestigial sideband shaping plus the required FCC group delay pre-correction. This new filter eliminates conventional receiver equalizers that require periodic maintenance with special test equipment. The equalized VIDEO SAW filter offers excellent performance year after year with absolutely no costly and time-consuming periodic realignment.

The precise phase equalization and the smooth, planar amplitude response of the new filter ensure a high degree of transparency to all types of video signals and test waveforms.

QUADRATURE CORRECTOR

The MCP-2U exciter uses a new and unique Quadrature Corrector that compensates for several types of klystron non-linearities, such as differential gain, incidental phase and intermodulation distortions. This highly versatile corrector provides the quality of transmitter performance that is required by modern receivers and subscription television decoders. Correction for incidental phase distortion reduces sync buzz and sync tip spikes, and also provides the low intercarrier noise performance that will be required for multi-channel TV sound in the future.

INDEPENDENT, SELF-CONTAINED UNIT

The MCP-2U is a completely self-contained unit that provides a fully processed on-channel picture signal. The unit contains an IF Modulator, vestigial sideband filter, up-converter, power supplies and all video and IF corrector circuits necessary to produce the on-channel signal.

The MCP-2U is mounted in a pull-out drawer which provides quick access to all adjustments and modules for setup and troubleshooting.

AVAILABLE FOR NON-HARRIS UHF TRANSMITTERS

The MCP-2U is standard in all Harris UHF-TV transmitters for System M (FCC) service. The MCP-2U is also available in a Harris exciter retrofit package for use in many non-Harris klystron transmitters.

*Visual IF Delay Equalized Output



FOR
SPECIFICATIONS
AND ORDERING
INFORMATION
PLEASE SEE
REVERSE SIDE

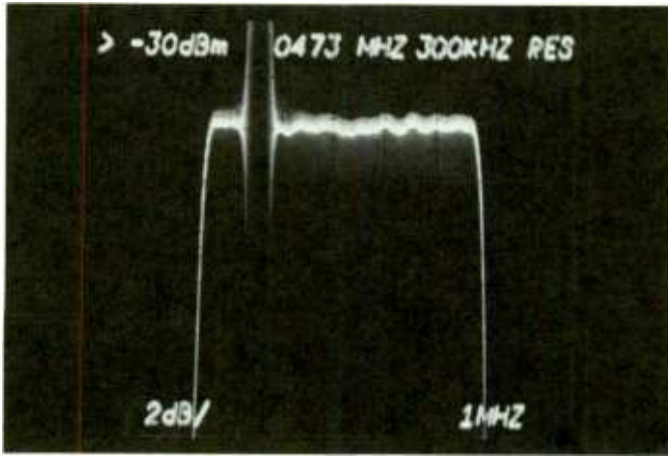

Sideband response of MCP-2U exciter showing passband (2 dB/cm) frequency response.

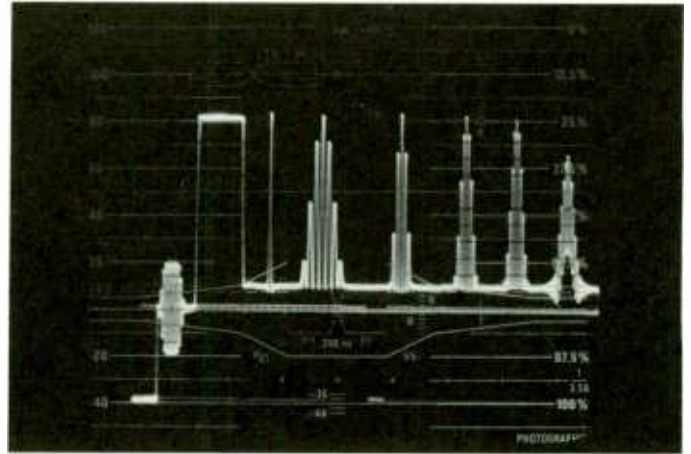

Multi-pulse shows excellent group delay, flat amplitude response and low echo of the MCP-2U visual exciter.

MCP-2U SPECIFICATIONS

VISUAL PERFORMANCE

POWER OUTPUT:
LOAD IMPEDANCE:
FREQUENCY RANGE:
CARRIER FREQUENCY STABILITY:¹
REG. OF RF OUTPUT POWER (all black to all white pic.):
VARIATION OF OUTPUT: (over one frame):
VISUAL SIDEBAND RESPONSE:

FREQUENCY RESPONSE VS. BRIGHTNESS:²
VISUAL MODULATION CAPABILITY:
DIFFERENTIAL GAIN:³
INCIDENTAL PHASE MODULATION:
LINEARITY (low frequency):⁴
DIFFERENTIAL PHASE:³
SIGNAL-TO-NOISE (total random and periodic noise unweighted):
K-FACTORS:
EQUIVALENT ENVELOPE DELAY:

VIDEO INPUT LEVEL:
HARMONIC RADIATION:⁵

SERVICE CONDITIONS

AMBIENT TEMPERATURE:
AMBIENT HUMIDITY RANGE:
ALTITUDE:
PHYSICAL AND MECHANICAL DIMENSIONS:
ELECTRICAL REQUIREMENTS:

System M/NTSC

.75 watt peak.
 50 ohms. Output connector: BNC.
 470-806 MHz (Channels 14-69).
 ± 500 Hz (maximum variation over 30 days).
 1% or less relative to sync peak.
 Less than 1%.
 -1.25 MHz and lower -30 dB or better
 -0.75 MHz to +4.18 MHz ± 0.3 dB
 +4.18 MHz +0.3, -0.5 dB
 +4.5 MHz -10 dB or better
 +4.75 MHz and higher -40 dB or better
 ± 0.25 dB.
 0%.
 3% or better.
 $\pm 2^\circ$ or better relative to blanking.
 3% or better.
 $\pm 1^\circ$ or better.
 -58 dB RMS or better relative to sync peak.
 2T 1%, 20T less than 3% baseline disturbance.
 0.2 to 2.1 MHz ± 40 ns
 at 3.58 MHz ± 25 ns
 at 4.18 MHz ± 60 ns
 (referenced to FCC standard curve)
 75 ohm, -30 dB or better return loss up to 5.5 MHz.
 -40 dB relative to peak of sync.

-10° to +60°C (14 to 140°F).
 0 to 95% relative humidity.
 Sea level to 10,000 feet.
 24" W x 22" D x 5.25" H. Weight: 38 lbs.
 105-125 VAC or 210-250 VAC, 50/60 Hz.
 Power consumption: 150 VA maximum.

SPECIFICATIONS SUBJECT TO CHANGE WITHOUT NOTICE.

1. After initial aging of 60 days.
2. Measured using 20% p.p amplitude swept video modulation with pedestal set at black 10%, white 90% with reference to grey level 50%. All percentages relative to blanking to white excursion.
3. Measured with a 5-step riser signal from 75% to 12.5% of sync peak. Sub-carrier mod. percentage 12.5% peak to peak.
4. Measured with a 5-step riser signal. Test signal No. 3 CCIR REC 421-3.
5. The MCP-2U exciter does not provide sufficient selectivity in the exciter alone to meet FCC transmitter specifications for -3.58 MHz suppression or harmonic radiation. However when the MCP-2U is used in a Harris IF modulated transmitter, FCC performance requirements in these areas will be met or exceeded.

ORDERING INFORMATION

MCP-2U UHF visual replacement exciter for Harris/Gates transmitters
 not equipped with MCP exciters 994-8718-001
 MCP-2U UHF visual replacement exciter for 220 kW Harris/Gates
 transmitters or 30 kW and 55 kW Harris/Gates transmitters equipped with
 TE-1U spare exciter cabinet 994-8718-002
 UHF aural exciter 994-8012-003
 UHF exciter retrofit package for use as klystron driver in
 non-Harris transmitters. 10 watts visual, 5 watts aural 790-XXXX-XXX



HARRIS

CPV

Circularly Polarized Television Antenna

- Top mount design
- Excellent axial ratio—reduces ghosting effects
- High power handling capabilities
- Requires no electrical deicing
- Superb horizontal circularity
- Excellent control of vertical pattern
- Directional pattern capability
- Antenna elements are at DC ground potential for lightning protection
- Dual or single line input

In addition to its outstanding mechanical specifications, the Harris CPV antenna also features excellent circularity (standard omnidirectional pattern varies less than ± 2 dB); low axial ratio (less than 2 dB); VSWR less than 1.05:1 at visual carrier and below 1.1:1 over each channel; directional horizontal pattern capability; and a variety of vertical patterns that may be tailored to specific coverage requirements. Harris has spent years in research and development of the CP concept for TV broadcasting, so that the current design now combines optimum circularly polarized performance with all of the regular features of the Harris line of television antennas.

With the Harris CPV, picture quality may be improved through ghost reduction. Also, increased signal-to-noise ratios may be achieved whether the viewer uses a CP receiving antenna, conventional rabbit ears or an ordinary outside receiving antenna.

Harris' CPV Antenna...excellent axial ratio reduces ghosting effects

DESIGN

Each bay of the CPV consists of three crossed vee dipoles mounted at 120° intervals around a vertical mast. These dipoles are separated by three vertical grids which isolate the vee dipoles and provide horizontal beam shaping. Each set of crossed dipoles is fed in phase quadrature to produce rotating RF energy. The signal emanating from each set of dipoles is considered right hand circular since the field rotation is clockwise as viewed in the direction of propagation.

The Harris CPV is available with power ratings up to 100 kilowatts, and a special wideband flat dipole is used to safely handle the required power levels. Each dipole is mechanically supported and fed from special baluns for both vertical and horizontal polarization.

RADOMES

Fiberglass radome covers are standard, and protect the radiating elements from exposure to moisture, ice and atmospheric corrosives. Consequently, the CPV antenna is very insensitive to performance degradations caused by the environment. As the need for electrical



deicing is eliminated, substantial annual savings in power costs can result—in addition to the initial savings in not having to purchase deicer elements, transformers and wiring.

AXIAL RATIO

The CPV has superb axial ratio characteristics as a direct result of the precise tailoring of the radiated pattern of the vee dipoles. Axial ratio, the ratio of the major and minor axes of the polarization ellipse, critically defines the quality of a radiating element. When circularly polarized receiving antennas are used by the viewer, reflected signals may be attenuated, thereby reducing ghosting effects.

VERTICAL PATTERN

Vertical pattern contouring to introduce beam tilt and null fill may be provided by means of standard phase distribution techniques—such as those used in many successful Batwing installations. Control of the vertical pattern is accomplished with no degradation of the axial ratio. Therefore, contoured vertical patterns are available much the same as in conventional horizontally polarized TV antennas.

HORIZONTAL CIRCULARITY

For omnidirectional stations, the shape of the horizontal pattern will vary from circular by less than ± 2 dB. Stations employing directional arrays will find one of the several patterns available to be ideally suited to their specific need.

INPUT CONNECTIONS

The CPV antennas are uniquely designed in a manner that permits the use of either single or dual transmission lines. This feature permits maximum flexibility for the broadcaster who is replacing an existing antenna or planning a completely new installation.

The standard TAV-6L low band CPV antenna is supplied with dual $3\frac{1}{8}$ " , 50 ohm input connections. The upper and lower halves of the antenna are each fed by a separate, independent transmission line, a feature that permits using one-half of the antenna in an emergency situation (with appropriate patching) with only a minor reduction in signal strength. The TAV-6L may also be supplied with a single input connection.

The standard TAV-12H high band CPV antenna is supplied with a single $6\frac{1}{8}$ " , 50 ohm input connection. The TAV-12H may also be supplied with a dual line input, which will permit feeding power to one-half of the antenna in an emergency.

All CPV antenna masts are hot dip galvanized and all hardware is stainless steel for excellent corrosion protection.

CPV Low Band — Channels 2 - 6

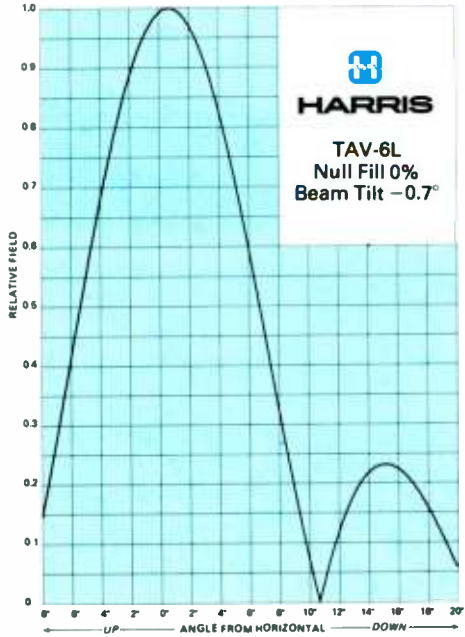

TYPICAL CALCULATED ELEVATION FIELD PATTERNS

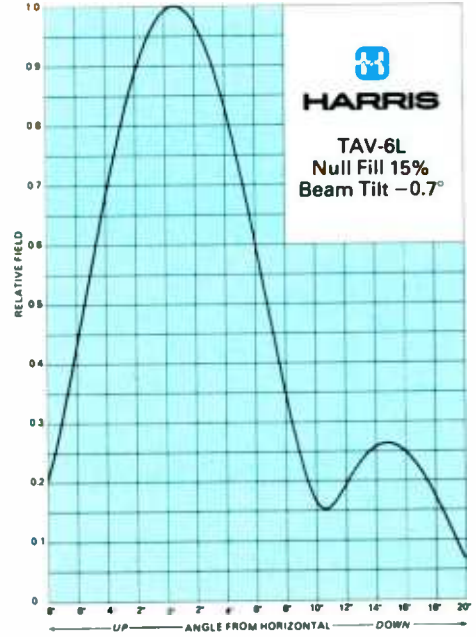

TAV-6L Gain Vs. 1st Null Fill

Null Fill	Power Gain (per polarization)
0%	2.98
5%	2.96
10%	2.92
15%	2.82
20%	2.72
25%	2.66
30%	2.42

TAV-6L, Ch. 6 Measured VSWR

Lower Channel Edge:	1.095 to 1
Visual Carrier:	1.05 to 1
Color Sub-carrier:	1.06 to 1
Aural Carrier:	1.09 to 1
Upper Channel Edge:	1.10 to 1

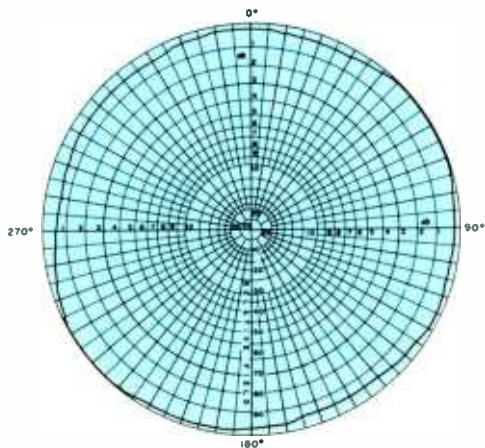
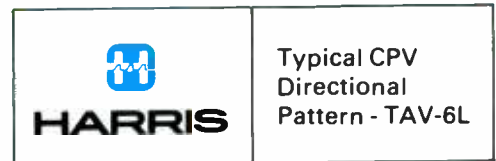

TYPICAL CALCULATED AZIMUTH FIELD PATTERNS

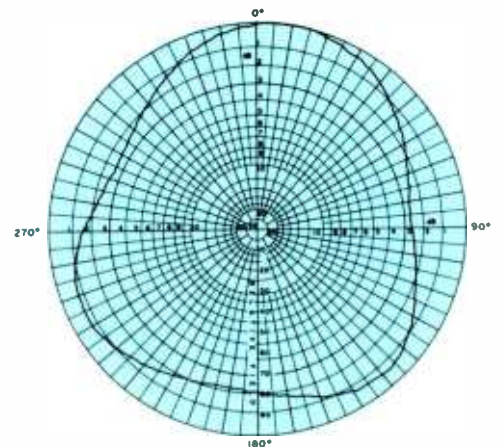

TAV-6L Mechanical Specifications

Channel	Antenna Height (ft.)	Rad. Center (feet)	Moment (ft.-lbs.)	Shear (lbs.)	Weight (lbs.)
2	95.5	46.25	337,000	9,450	16,000
3	88.0	42.33	291,000	8,900	15,000
4	80.5	38.75	232,000	7,650	13,000
5	74.0	35.25	174,000	6,700	11,000
6	70.0	32.60	164,000	6,450	10,100

Note: Antennas are designed in accordance with the American Institute of Steel Construction Code. The loading data shown in the table is based on a wind pressure of 50 lbs. per sq. ft. acting normal to flat surfaces. Loading data includes windload effects for beacon (not provided by Harris), and also bury sections if not flange mounted.

TAV-6L Electrical Specifications

Channel Range:	FCC Channels 2-6 (54-88 MHz).
Power Gain (10% Null Fill):	2.92 (4.55 dB) per polarization.
Input Connector:	Dual 3/8", 50 ohm.
Input Power Rating:	70 kW visual with 20% aural.
Input VSWR:	
Visual Carrier:	1.05 to 1.
Color Sub-carrier:	1.08 to 1.
Rest of Channel:	1.10 to 1.
Axial Ratio:	2 dB.
Circularity:	±2 dB.

Low Band CPV Ordering Information

When ordering Harris low band CPV antennas, please specify channel number, pattern, beam tilt and null fill. Antennas supplied with lightning protector, beacon cable and primer coating. Assistance with antenna assembly and ground test also supplied. Beacon, painting and ground support structures not included. Standard antenna is bury mounted.

TAV-6L six bay CPV antenna, Channels 2,3 **994-8602-00X**
TAV-6L six bay CPV antenna, Channels 4, 5 and 6 **994-8602-0XX**

NOTE: Four and five bay CPV antennas for Channels 2-6 are available on request. All antennas are F.O.B. Harris' antenna facility, Palmyra, Missouri.

Options and Accessories

Input Connector:	Dual 4-1/16" or single line.
Pattern:	Directional.
Test Range Pattern Measurements	
Notch Diplexer:	TD-60L, 66 kW rating, Channels 2-6.
Antenna Mounting:	Flange mounted.

CPV High Band — Channels 7 - 13

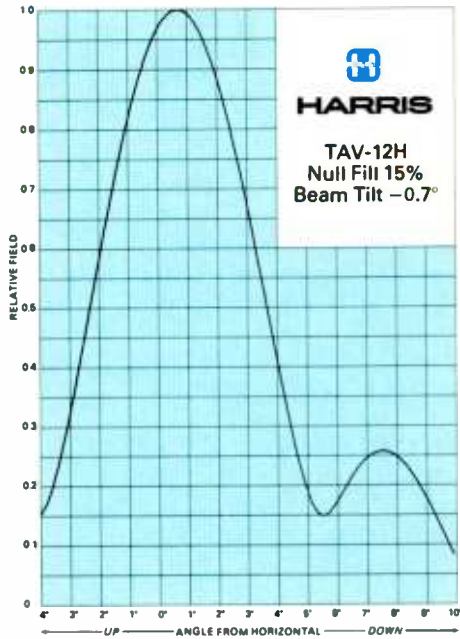

TYPICAL CALCULATED ELEVATION FIELD PATTERNS

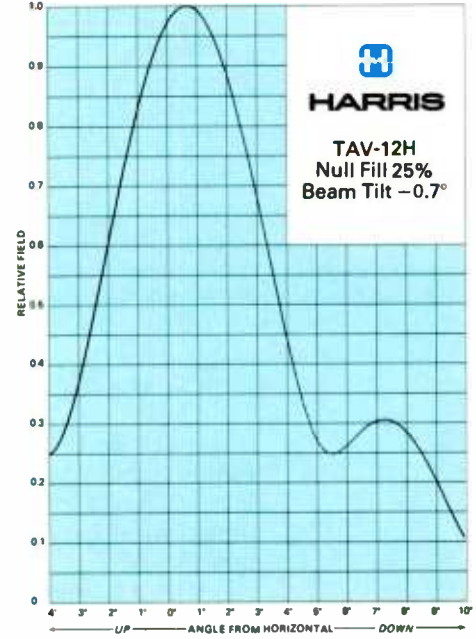

**TAV-12H
Gain Vs. 1st Null Fill**

Null Fill	Power Gain (per polarization)
0%	6.08
5%	6.05
10%	5.96
15%	5.81
20%	5.62
25%	5.36
30%	5.10

**TAV-12H, Ch. 11
Measured VSWR**

Lower Channel Edge:	1.038 to 1
Visual Carrier:	1.012 to 1
Color Sub-carrier:	1.015 to 1
Aural Carrier:	1.017 to 1
Upper Channel Edge:	1.020 to 1

HARRIS Typical CPV Omnidirectional Pattern - TAV-12H

HARRIS Typical CPV Directional Pattern - TAV-12H

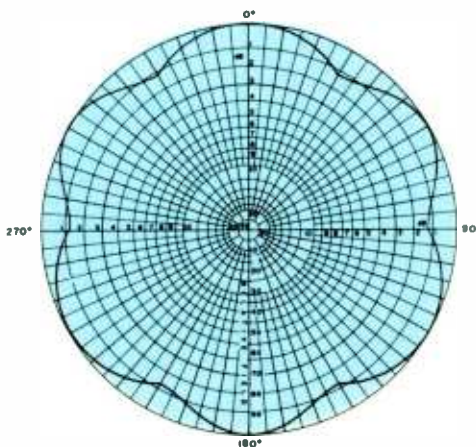

TYPICAL CALCULATED AZIMUTH FIELD PATTERNS

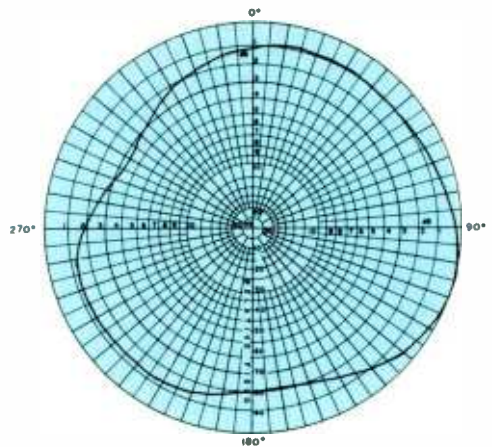

TAV-12H Mechanical Specifications

Channel	Antenna Height (ft.)	Rad. Center (feet)	Moment (ft.-lbs.)	Shear (lbs.)	Weight (lbs.)
7	69.0	32.7	172,750	5,275	9,150
8	68.2	32.3	169,400	5,250	9,050
9	65.0	30.7	155,550	5,050	8,800
10	64.2	30.3	152,250	5,000	8,750
11	60.7	28.6	136,550	4,725	8,000
12	60.7	28.6	136,550	4,725	8,000
13	59.0	27.7	130,700	4,650	7,600

Note: Antennas are designed in accordance with the American Institute of Steel Construction Code. The loading data shown in the table is based on a wind pressure of 50 lbs. per sq. ft. acting normal to flat surfaces. Loading data includes windload effects for beacon (not provided by Harris), and also bury sections if not flange mounted.

TAV-12H Electrical Specifications

Channel Range:	FCC Channels 7-13 (174-216 MHz).
Power Gain (15% Null Fill):	5.81 (7.64 dB) per polarization.
Input Connector:	Single 6 $\frac{1}{8}$ " , 50 ohm.
Input Power Rating:	75 kW visual with 20% aural.
Input VSWR:	
Visual Carrier:	1.05 to 1.
Color Sub-carrier:	1.08 to 1.
Rest of Channel:	1.10 to 1.
Axial Ratio:	2 dB.
Circularity:	\pm 1.5 dB.

High Band CPV Ordering Information

When ordering Harris high band CPV antennas, please specify channel number, pattern, beam tilt and null fill. Antennas supplied with lightning protector, beacon cable and primer coating. Assistance with antenna assembly and ground test also supplied. Beacon, painting and ground support structures not included. Standard antenna is flange mounted.

TAV-12H twelve bay CPV antenna, Channels 7-13	994-8707-001
TAV-12H twelve bay CPV antenna, Channels 7-13, as above, except with dual 3$\frac{1}{8}$" , 50 ohm input	994-8707-002

NOTE: 8, 10, 14, 16 and 18 bay CPV antennas for Channels 7-13 are available on request. All antennas are F.O.B. Harris' antenna facility, Palmyra, Missouri.

Options and Accessories

Input Connector:	Dual 3 $\frac{1}{8}$ " or dual 4-1/16" , 50 ohm.
Pattern:	Directional.
Test Range Pattern Measurements	
Notch Diplexer:	TD-100H, 100 kW rating, Ch. 7-13.
Impedance Transformer:	6 $\frac{1}{8}$ " 50 ohm to 6 $\frac{1}{8}$ " 75 ohm.
Power Splitter for Dual Line Feed	
Antenna Mounting:	Bury mounted.



HARRIS

CIRCULARLY POLARIZED TELEVISION ANTENNA

- Excellent axial ratio--reduces ghosting effects
- Wide bandwidth permits multiplexing of all V.H.F. high-band and T.V. channels
- High power handling capabilities
- Requires no electrical de-icing when used with radomes
- Wire-mesh cavity design minimizes windloading
- Superb horizontal circularity
- Excellent control of vertical pattern
- Antenna elements are at D.C. ground potential for lightning protection
- Horizontal elements may be driven independent of vertical elements

The new Harris Cavity Backed Radiator (CBR) circularly polarized television broadcast antenna offers the ultimate in television signal transmission and reception. Whether the viewer uses a circularly polarized receiving antenna, conventional rabbit ears or ordinary outside receiving antenna, picture quality may be improved with the reduction of ghosting and/or increased signal to noise ratios.

In addition, the extremely wide bandwidth inherent in Harris' CBR antennas permits multiplexing of any two or more stations in the VHF high-band channels. All cavity backed radiators are designed, built and tested at the Harris antenna test facility, assuring the optimum in axial ratio, horizontal circularity and vertical pattern shape.

CBR DEVELOPMENT. Harris has spent more than 2 years in research and development of the circular transmission concept for television broadcasting. Basic design objectives of the CP antenna stressed optimum circularly polarized performance, combined with all of the conventional features of the Harris line of television antennas. Theoretical design followed by extensive prototype testing has proven the CBR to be the best approach to circularly polarized transmission to date.



The Harris Cavity Backed Radiator consists of a crossed dipole radiator fed in phase quadrature and mounted within a circular cavity director. Rotating RF energy is produced when the cavity is excited by the dipole elements. The signal emanating from the cavity is considered right-hand circular when the field of rotation is clockwise as viewed in the direction of propagation. Cavity size is principally determined by beamwidth requirements. A beamwidth of 90 degrees is required for a 4-around array and 120 degrees is required for a 3-around array, (measured at the half-voltage coordinates).

GRID CAVITY. The cavity used in the Harris circularly polarized television antenna is welded steel grid which is then galvanized. The cavity grid is supported from a center mounting plate, which also serves as a mounting for the dipole assembly and for attachment of the unit to the supporting structure.

Radomes, standard with the Harris CBR circularly polarized TV antenna, eliminate the need for electrical de-icing in virtually all environments. This can save hundreds of dollars per year in electrical heating costs--in addition to the savings in not having to purchase heater elements, transformers and wiring. The combination of grid cavities and aerodynamically designed radomes minimizes windloading of the Harris C P antenna.

DIPOLE ELEMENTS. A special wideband flat dipole is used for excitation of the cavity and to safely handle the required power

levels. Each dipole is mechanically supported and fed from special baluns for both vertical and horizontal polarization. Because of their independent nature, either the horizontal or both sets of elements may be driven to provide horizontal or circular polarization. In addition, the baluns provide D.C. ground potential to each dipole element for lightning protection for antenna and transmitter.

AXIAL RATIO. The Harris CBR antenna has superb axial ratio characteristics as a direct result of the precise tailoring of the radiated pattern by the cavity. Axial ratio, the ratio of the major and minor axes of the polarization ellipse, critically defines the quality of a radiating element. When circularly polarized receiving antennas are used by the viewer, reflected signals are attenuated, thereby reducing ghosting effects.

WIDE BANDWIDTH. Maximum utilization of antenna aperture is realized with the Harris CP antenna because two, three or more VHF high-band stations may feed one structure. Multiplexing has become a significant factor in reducing station costs in view of the recent increases in the price of tower structures. The broadband radiating element used in conjunction with conventional high power hybrid junctions assures excellent performance over all channels from 7-13. VSWR is 1.1:1 or better at any frequency between channels 7 and 13 as illustrated in the measured VSWR graph on the facing page.

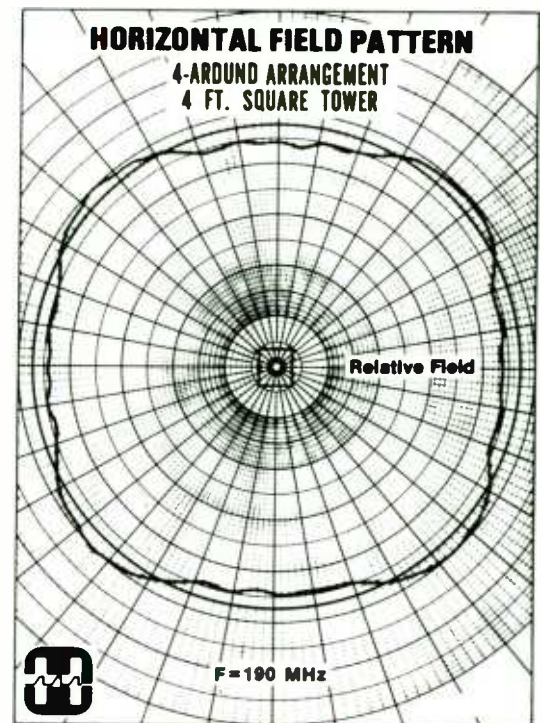
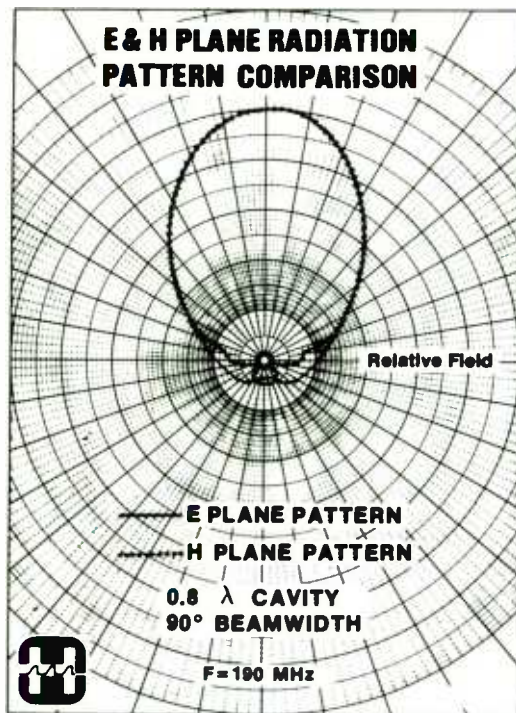

HIGH POWER CAPABILITIES. The Harris CP antenna is designed for multiplex applications as well as single station operation. Up to 100kW power ratings are available for single transmitter operation. For dual station operation, up to 150kW input may be accommodated. For applications requiring the multiplexing of more than two stations, special high power feed systems are available.

VERTICAL PATTERN. Vertical pattern contouring to introduce beam tilt and null fill may be provided by means of standard phase distribution techniques such as has been used in many successful Batwing installations. Control of the vertical pattern is accomplished with no degradation of the axial ratio. Therefore, contoured vertical patterns are available much the same as in conventional horizontally polarized TV antennas.

HORIZONTAL CIRCULARITY. For omnidirectional stations, the shape of the horizontal pattern will vary from omni by less than ± 2 dB for three-sided tower configurations. With a four-around antenna array, the typical circularity will be comparable.

Stations employing directional arrays will find one of the several patterns available to be ideally suited to their specific need.

The Harris Cavity Backed Radiator circularly polarized antenna marks a new dimension in television broadcasting. The excellent axial ratio, superb horizontal and vertical patterns and application flexibility make it a technically superior antenna. Careful design consideration of important mechanical details assures a long and dependable lifespan. No matter what your VHF high band television antenna requirements may be... Harris has a circularly polarized antenna to meet them.

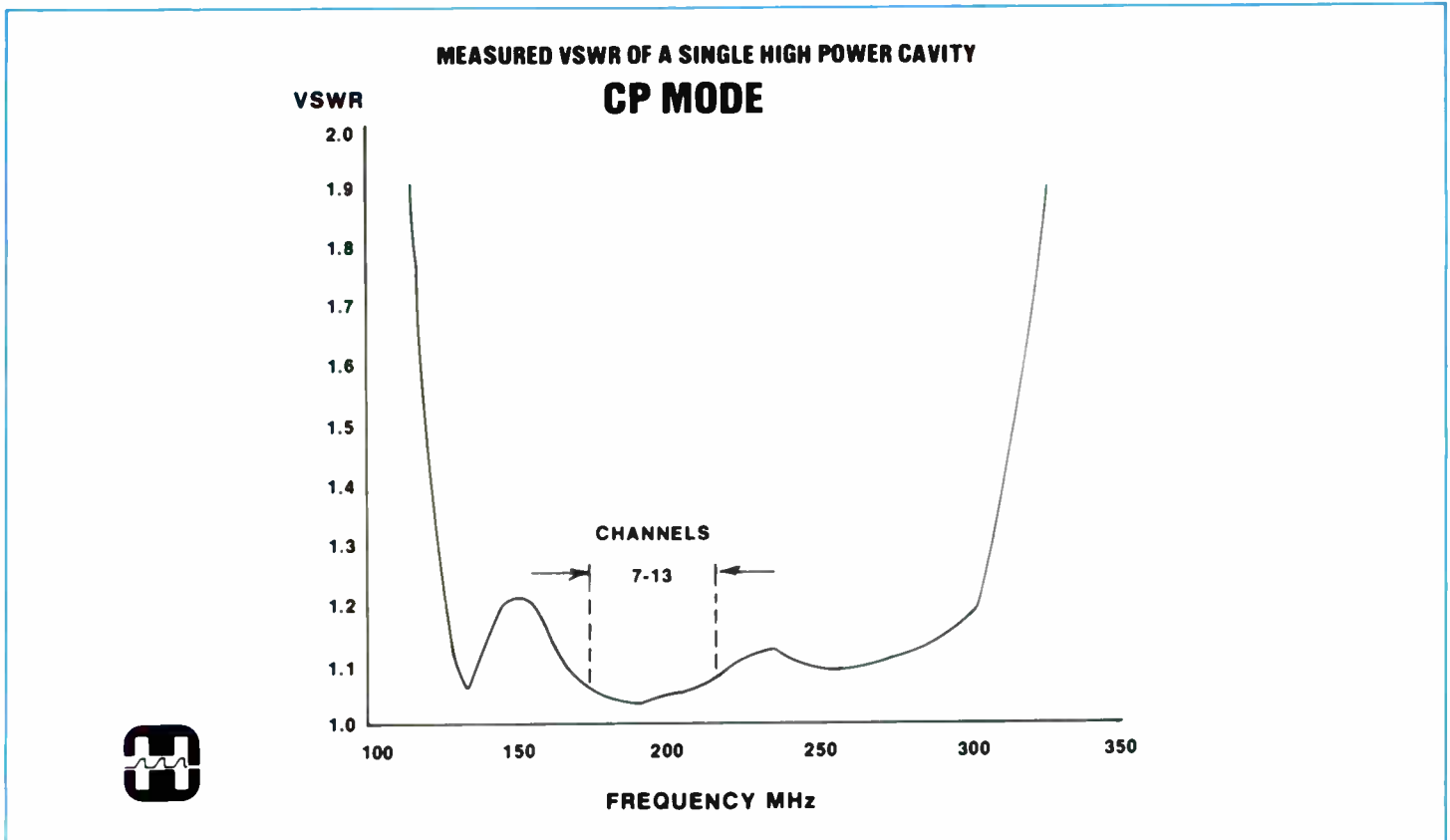
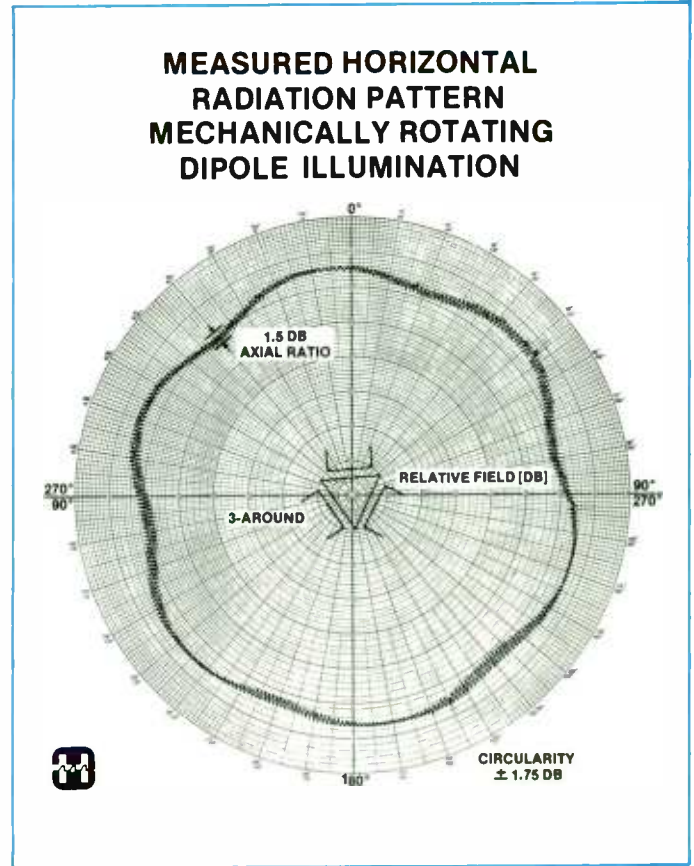

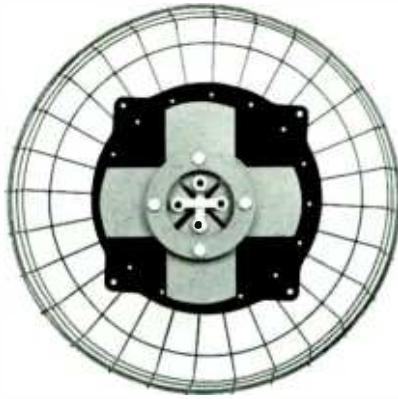

Single radiating element of the Harris C P antenna



Radomes eliminate the need for electrical de-icing equipment

WINDLOADING

[Triangular Mast with Radomes]

CHANNEL	NO. OF BAYS	MAST LENGTH [FEET]	SHEAR @ 50 PSF [LBS]	MOMENT [FT. LBS.]	WEIGHT [LBS.]
7	6	34.0	4,885	83,045	5,425
7	8	45.3	6,550	148,360	7,350
7	10	56.5	8,350	235,890	9,300
7	12	67.7	10,205	345,440	11,500
8	6	33.2	4,770	79,185	5,300
8	8	44.0	6,355	139,810	7,150
8	10	55.0	8,130	223,575	9,075
8	12	65.8	9,925	326,535	11,175
9	6	32.2	4,625	74,465	5,150
9	8	42.7	6,175	131,840	6,950
9	10	53.2	7,875	209,475	8,775
9	12	63.7	9,600	305,760	10,825
10	6	31.4	4,510	70,810	5,025
10	8	41.6	6,010	125,010	6,750
10	10	51.7	7,650	197,775	8,525
10	12	62.0	9,350	289,850	10,525
11	6	30.7	4,410	67,700	4,900
11	8	40.6	5,865	119,060	6,600
11	10	50.5	7,475	188,750	8,325
11	12	60.4	9,110	275,125	10,250
12	6	30.0	4,310	64,650	4,800
12	8	39.5	5,710	112,775	6,425
12	10	49.1	7,260	178,250	8,100
12	12	58.7	8,850	259,750	9,975
13	6	29.3	4,210	61,680	4,675
13	8	38.7	5,590	108,200	6,275
13	10	48.0	7,100	170,400	7,900
13	12	57.3	8,640	247,550	9,725

SPECIFICATIONS

	SINGLE CHANNEL	MULTIPLEX
VSWR	1.1:1	1.1:1
GAIN/BAY	UNITY	UNITY
CIRCULARITY (Top Mount)	± 2 dB	± 3 dB
AXIAL RATIO	< 2 dB	< 2 dB
POWER RATING	100 kW	150 kW



HARRIS

QUADRAPOWER

UHF Television Antenna

- Unlimited range of patterns
- Omnidirectional gains up to 45
- High power handling capability
- Radomes for reduced windloading
- High reliability, low maintenance
- Factory assembled and tested—no field tuning required

Harris' Quadrapower antennas are panel type antennas specifically designed for high power UHF transmission with omnidirectional patterns.

The antenna consists of four panels per bay mounted on a square mast section. The antenna may be top mounted on a tower or the panels may be supplied without the mast for side mounting on a tower or other structure.

Starting with the original Harris Zig-Zag antenna design, Harris re-engineered the antenna to provide the Quadrapower's improved performance and mechanical specifications. Smooth vertical patterns are the result of computer-aided optimization of the feed system and panel pattern shape. Lower windloading is achieved by the addition of radome covers that give the antenna a nearly cylindrical profile.

The mast is constructed of structural quality steel, the panels are of structural grade aluminum to minimize weight, and the radiating elements are sturdy "Copperweld" steel supported by low-loss insulators. The RF transparent radomes are of fiberglass construction, and are color impregnated so that they never require painting. All materials used in the antenna are corrosion resistant to insure long life, low maintenance and optimum performance.

Custom Patterns

Because of its multiple panel construction, the Quadrapower antenna can easily provide an unlimited number of directional patterns in the horizontal plane. This high degree of pattern

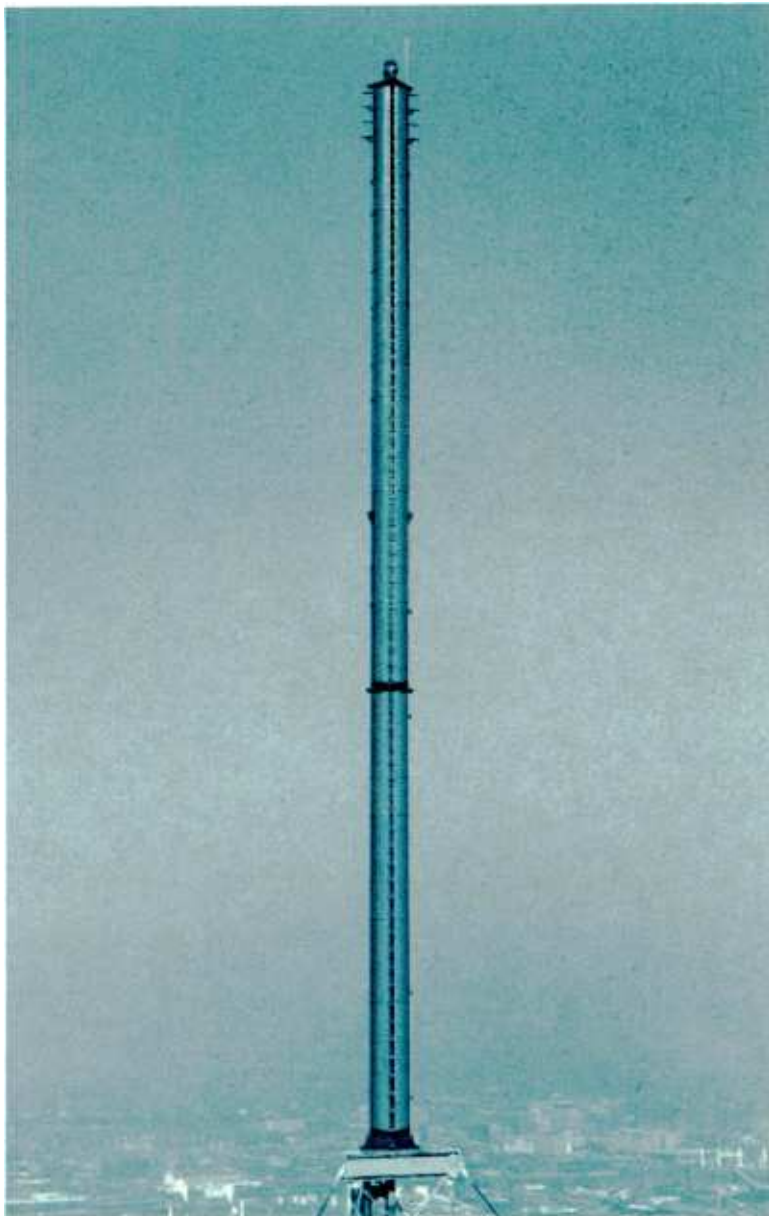

Harris UHF Quadrapower Antennas offer

flexibility enables the Harris antenna engineers to custom design a pattern to meet the specific requirements of each station. This pattern shaping permits the most efficient use of available transmitter power to cover a geographic area.

Computer-aided design is used extensively to rapidly and accurately calculate nearly any desired pattern.

Radomes

Quadrapower antennas may be equipped with radome covers that significantly reduce windloading and eliminate the need for electrical deicing. The radome covers effectively protect the antenna elements from precipitation, and are constructed so that they can be easily removed for inspection or maintenance of one antenna panel at a time.

Electrical deicing is available on non-radomed Quadrapower antennas.

Input Connections and Power Ratings

The standard input connector is 6 1/8-inch, 75 ohm coax line to permit power levels up to 75 kilowatts. Since the antenna feed system is conservatively designed for safe high power operation, 8 3/16-inch coax, 9 3/16-inch coax, waveguide or dual 6 1/8-inch coax input connectors can be supplied for input power levels of 110 kilowatts or greater.

Assembly and Testing

To insure the best possible performance, every Quadrapower antenna is completely assembled and tested at the Harris antenna facility in Palmyra, Missouri. In addition to the testing of each panel and bay, the entire antenna is tested for correct azimuth pattern, elevation pattern and VSWR.

Length permitting, Quadrapower antennas are shipped fully assembled. The factory assembly and testing, along with one-piece shipping, minimize installation time required after delivery to the antenna site.

Filing Information Available

Complete specifications and filing information are available on request. Harris antenna engineers are also available by telephone to discuss your specific antenna requirements.

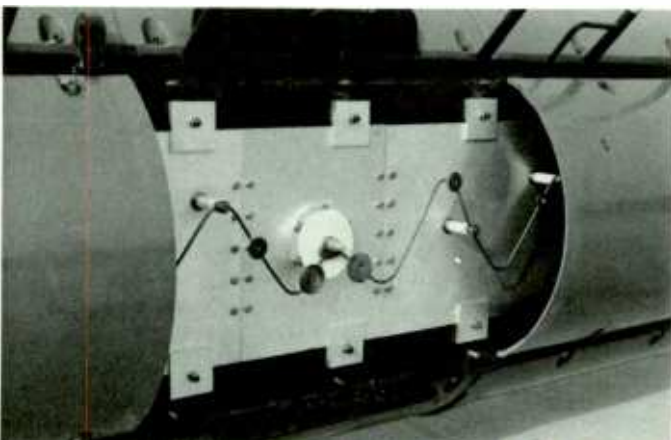

Quadrapower panel, radome removed

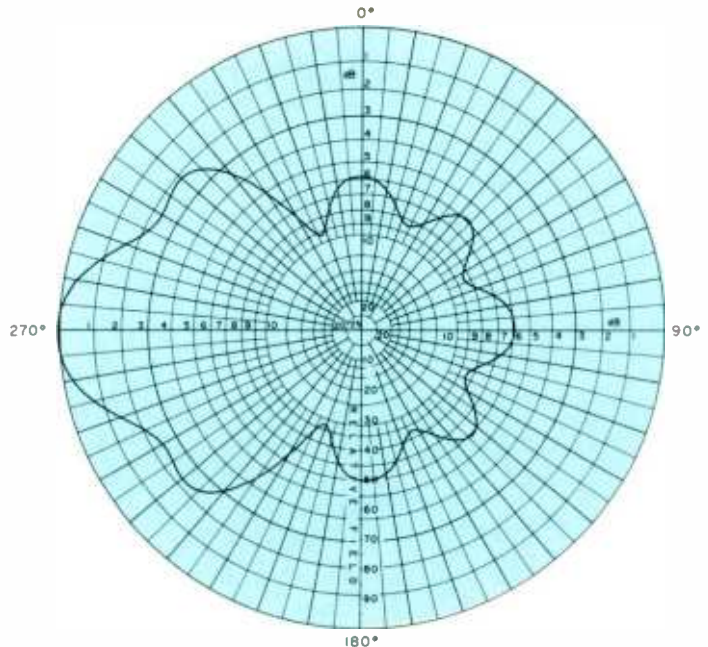

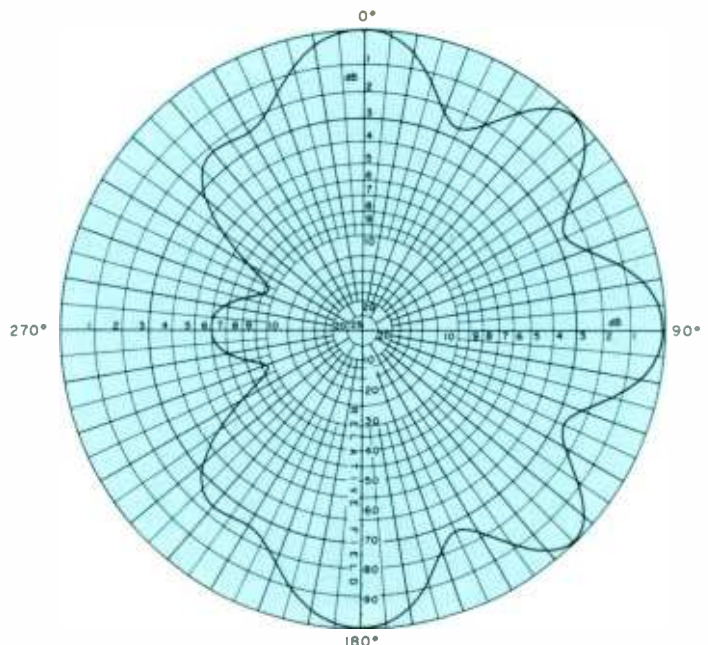

TYPICAL CALCULATED

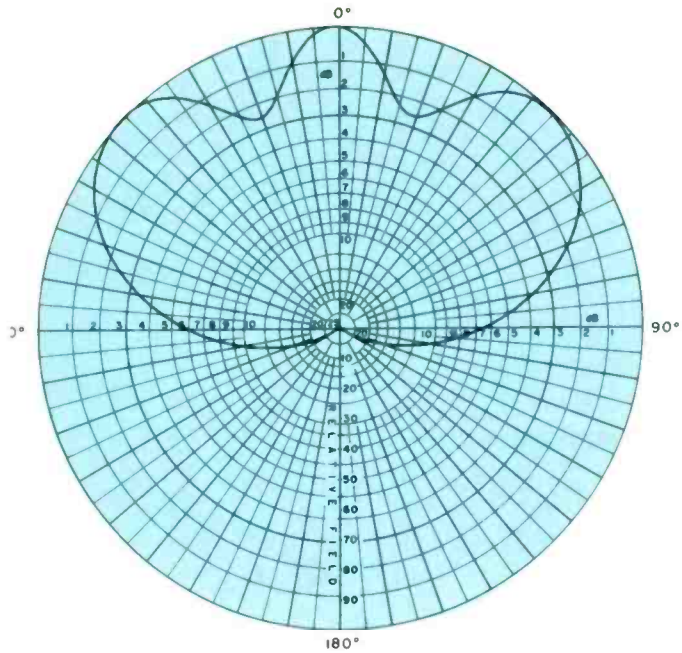

an unlimited range of patterns

 HARRIS	GAIN: Ratio = 2.60 dB = 4.15
--	---------------------------------



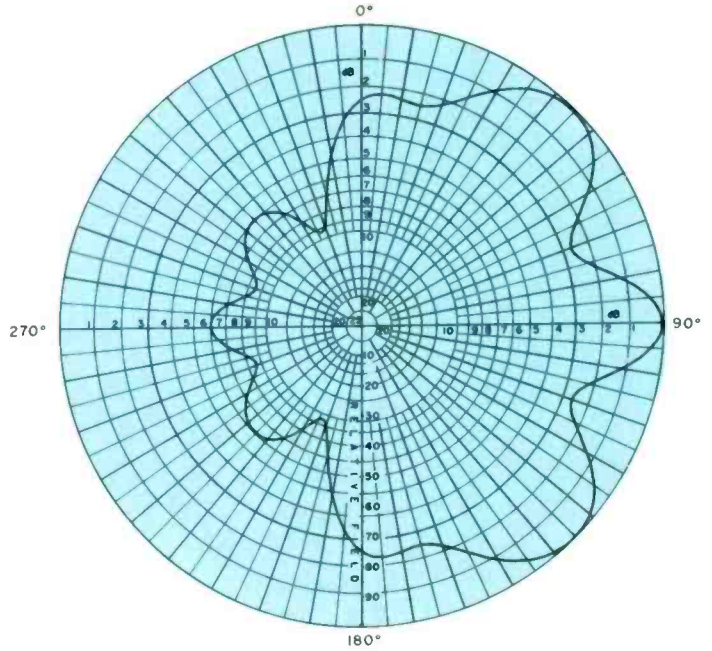

 HARRIS	GAIN: Ratio = 2.04 dB = 3.09
--	---------------------------------

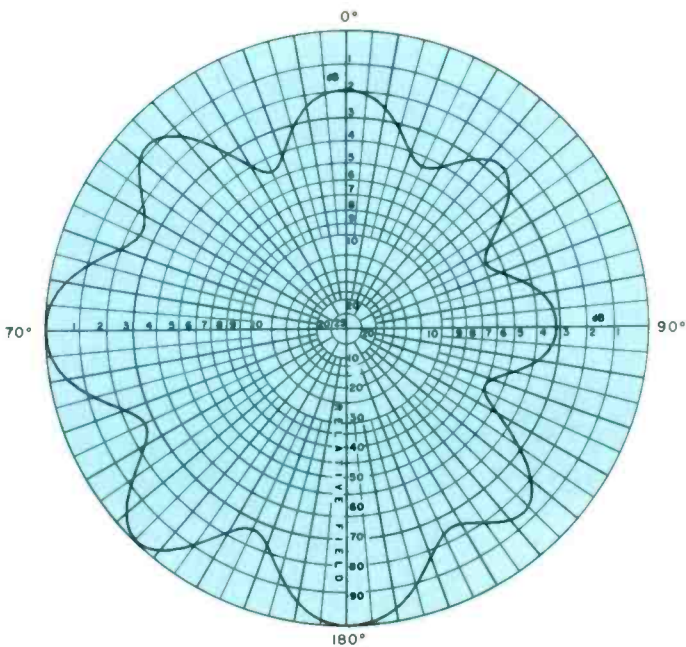

HORIZONTAL FIELD PATTERNS

 HARRIS	GAIN: Ratio = 1.62 dB = 2.09
--	---------------------------------



 HARRIS	GAIN: Ratio = 2.04 dB = 3.10
---	---------------------------------

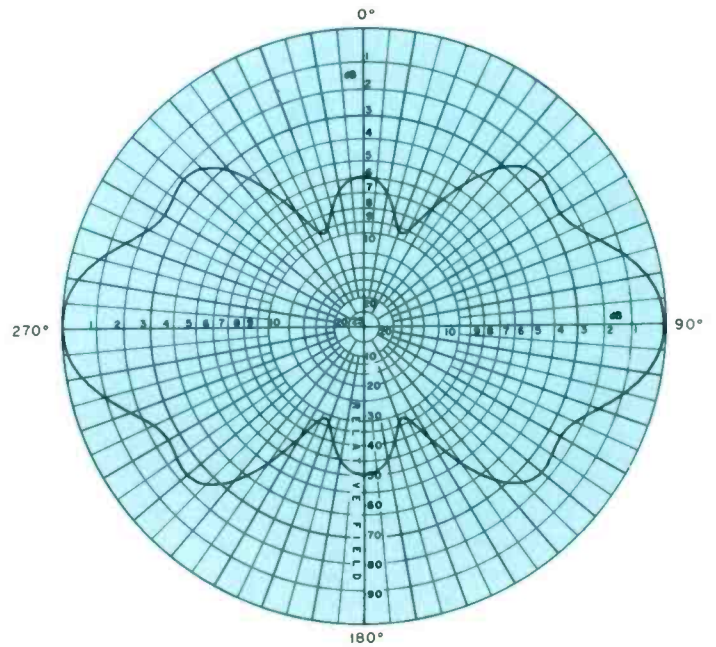

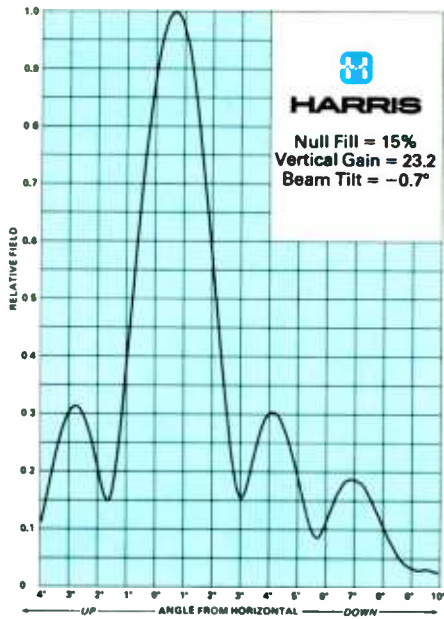

TAZ-24U
3-bay

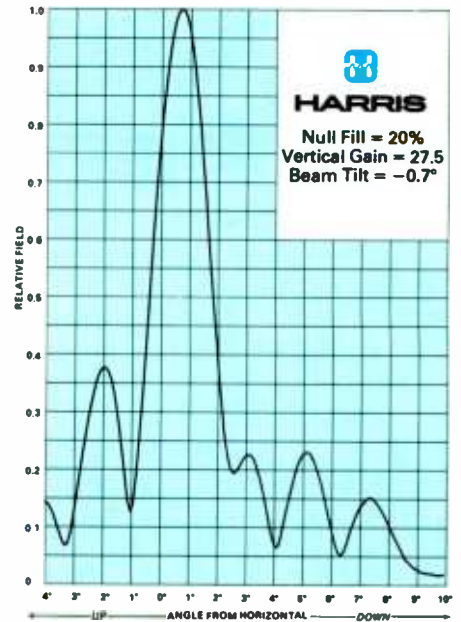

TAZ-31U
4-bay

TAZ-45U
TAZ-38U
TAZ-31U
TAZ-24U

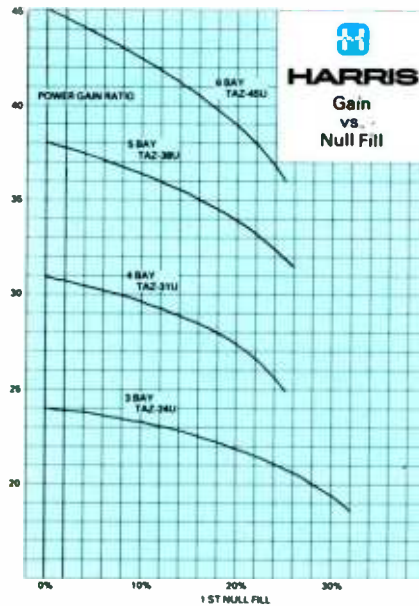

TYPICAL CALCULATED VERTICAL FIELD PATTERNS

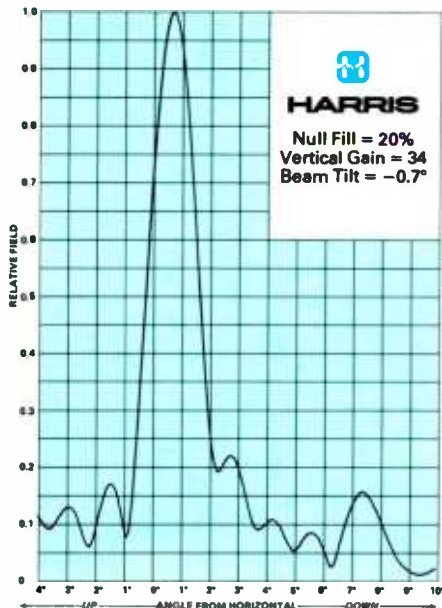

TAZ-38U
5-bay

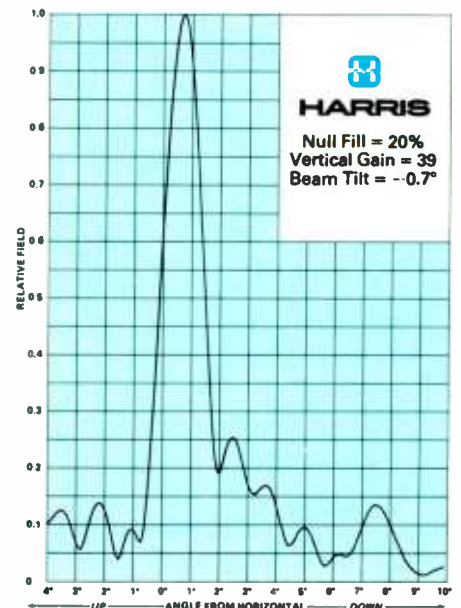

TAZ-45U
6-bay

UHF Quadrapower Specifications

Channels	Type	Power Gain-Maximum		Input Power		Antenna ht. - ft.	Radiation Center - ft.	Moment ft. - lbs.	Shear ft. - lbs.	Weight lbs.
		Ratio	dB	kW	dBk					
14 thru 16	TAZ-24U	24.0	13.80	75.0	18.75	55.3	26.0	163,489	6,373	8,000
	TAZ-24UR	24.0	13.80	75.0	18.75	55.3	26.0	153,825	5,900	8,000
	TAZ-31U	31.0	14.91	75.0	18.75	72.5	34.6	345,627	10,091	12,000
	TAZ-31UR	31.0	14.91	75.0	18.75	72.5	34.6	271,975	7,850	12,000
	TAZ-38U	38.0	15.80	75.0	18.75	89.2	43.0	533,527	12,524	14,100
	TAZ-38UR	38.0	15.80	75.0	18.75	89.2	43.0	418,650	9,750	14,100
	TAZ-45U	45.0	16.53	75.0	18.75	105.9	51.3	762,093	14,957	15,000
	TAZ-45UR	45.0	16.53	75.0	18.75	105.9	51.3	596,875	11,625	15,000
17 thru 20	TAZ-24U	24.0	13.80	73.0	18.63	53.5	25.1	152,314	6,154	7,600
	TAZ-24UR	24.0	13.80	73.0	18.63	53.5	25.1	143,400	5,700	7,600
	TAZ-31U	31.0	14.91	73.0	18.63	70.0	33.4	320,992	9,727	11,500
	TAZ-31UR	31.0	14.91	73.0	18.63	70.0	33.4	252,725	7,550	11,500
	TAZ-38U	38.0	15.80	73.0	18.63	86.1	41.5	495,589	12,072	13,800
	TAZ-38UR	38.0	15.80	73.0	18.63	86.1	41.5	389,050	9,375	13,800
	TAZ-45U	45.0	16.53	73.0	18.63	102.2	49.5	707,952	14,418	14,800
	TAZ-45UR	45.0	16.53	73.0	18.63	102.2	49.5	554,675	11,200	14,800
21 thru 28	TAZ-24U	24.0	13.80	72.0	18.57	51.3	23.9	139,192	5,885	7,100
	TAZ-24UR	24.0	13.80	72.0	18.57	51.3	23.9	131,150	5,450	7,100
	TAZ-31U	31.0	14.91	72.0	18.57	67.1	31.9	293,557	9,304	10,900
	TAZ-31UR	31.0	14.91	72.0	18.57	67.1	31.9	231,275	7,250	10,900
	TAZ-38U	38.0	15.80	72.0	18.57	82.4	39.5	452,122	11,533	13,400
	TAZ-38UR	38.0	15.80	72.0	18.57	82.4	39.5	355,125	8,975	13,400
	TAZ-45U	45.0	16.53	72.0	18.57	97.7	47.2	644,774	13,762	14,600
	TAZ-45UR	45.0	16.53	72.0	18.57	97.7	47.2	505,425	10,700	14,600
29 thru 37	TAZ-24U	24.0	13.80	67.0	18.26	47.3	22.0	116,848	5,397	6,200
	TAZ-24UR	24.0	13.80	67.0	18.26	47.3	22.0	110,275	5,000	6,200
	TAZ-31U	31.0	14.91	67.0	18.26	61.8	29.3	246,583	8,532	9,600
	TAZ-31UR	31.0	14.91	67.0	18.26	61.8	29.3	191,900	6,600	9,600
	TAZ-38U	38.0	15.80	67.0	18.26	75.9	36.3	380,591	10,586	12,600
	TAZ-38UR	38.0	15.80	67.0	18.26	75.9	36.3	299,275	8,225	12,600
	TAZ-45U	45.0	16.53	67.0	18.26	89.9	43.0	542,306	12,626	14,100
	TAZ-45UR	45.0	16.53	67.0	18.26	89.9	43.0	425,500	9,800	14,100
38 thru 47	TAZ-24U	24.0	13.80	65.0	18.13	43.7	20.2	98,409	4,957	5,300
	TAZ-24UR	24.0	13.80	65.0	18.13	43.7	20.2	93,025	4,600	5,300
	TAZ-31U	31.0	14.91	65.0	18.13	57.0	26.6	207,573	7,832	8,400
	TAZ-31UR	31.0	14.91	65.0	18.13	57.0	26.6	164,000	6,100	8,400
	TAZ-38U	38.0	15.80	65.0	18.13	69.7	33.3	318,097	9,683	11,400
	TAZ-38UR	38.0	15.80	65.0	18.13	69.7	33.3	250,050	7,525	11,400
	TAZ-45U	45.0	16.53	65.0	18.13	82.5	39.7	453,270	11,548	13,400
	TAZ-45UR	45.0	16.53	65.0	18.13	82.5	39.7	356,025	8,975	13,400
48 thru 59	TAZ-24U	24.0	13.80	60.0	17.78	39.6	18.6	79,336	4,457	4,400
	TAZ-24UR	24.0	13.80	60.0	17.78	39.6	18.6	75,175	4,125	4,400
	TAZ-31U	31.0	14.91	60.0	17.78	51.8	24.4	169,099	7,075	7,100
	TAZ-31UR	31.0	14.91	60.0	17.78	51.8	24.4	133,875	5,500	7,100
	TAZ-38U	38.0	15.80	60.0	17.78	63.4	30.5	260,333	8,765	10,000
	TAZ-38UR	38.0	15.80	60.0	17.78	63.4	30.5	205,300	6,825	10,000
	TAZ-45U	45.0	16.53	60.0	17.78	75.1	36.3	372,212	10,470	12,500
	TAZ-45UR	45.0	16.53	60.0	17.78	75.1	36.3	292,750	8,150	12,500
60 thru 69	TAZ-24U	24.0	13.80	56.0	17.48	37.0	16.8	68,304	4,139	3,900
	TAZ-24UR	24.0	13.80	56.0	17.48	37.0	16.8	64,850	3,850	3,900
	TAZ-31U	31.0	14.91	56.0	17.48	48.0	22.1	143,476	6,521	6,300
	TAZ-31UR	31.0	14.91	56.0	17.48	48.0	22.1	113,800	5,075	6,300
	TAZ-38U	38.0	15.80	56.0	17.48	58.5	27.7	219,403	8,051	8,900
	TAZ-38UR	38.0	15.80	56.0	17.48	58.5	27.7	173,275	6,275	8,900
	TAZ-45U	45.0	16.53	56.0	17.48	69.0	32.9	311,393	9,581	11,300
	TAZ-45UR	45.0	16.53	56.0	17.48	69.0	32.9	245,225	7,450	11,300

Specifications subject to change without notice.

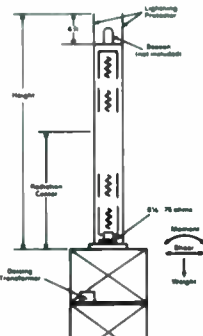

NOTES

1. Data given in the table above is for lowest channel and typical for others in the same group. Specific data available on request.
2. Power gain with 0% null fill and 0% beam tilt.
3. Input power is peak of sync visual power with 20% aural power.
4. Windload data for 50/33 PSF including effect of 300mm beacon (not supplied).

UHF QUADRAPOWER ANTENNA

Electrical Specifications

Channel Range: 14-69 (470-806 MHz).
Power Gain (omni): 24-45.
Input Connector: 6¹/₈" , 75 ohm.
Input Power Rating: 75 kW (Ch. 14) - 56 kW (Ch. 69).

Input VSWR:
Visual Carrier: 1.05 to 1.
Color Subcarrier: 1.08 to 1.
Rest of Channel: 1.1 to 1.
Circularity: ±2 dB (Ch. 14-37). ±2.5 dB (Ch. 38-69).
Deicer Power (non-radomed only): 500 watts per panel (2 kW per bay), 208/240 VAC, 60 Hz.

Specifications subject to change without notice.

Ordering Information

When ordering UHF Quadrapower antennas, please specify channel number, pattern, beam tilt and null fill. Antennas supplied with lightning protector, beacon cable and prime coating on mast. Assistance with antenna assembly and ground test also supplied. Beacon, painting and ground support structures are not included.

TAZ-24U three bay Quadrapower antenna	994-7623-001
TAZ-24U three bay Quadrapower antenna with deicing	994-7623-002
TAZ-24UR three bay Quadrapower antenna with radomes	994-7623-003
TAZ-31U four bay Quadrapower antenna	994-7624-001
TAZ-31U four bay Quadrapower antenna with deicing	994-7624-002
TAZ-31UR four bay Quadrapower antenna with radomes	994-7624-003
TAZ-38U five bay Quadrapower antenna	994-7625-001
TAZ-38U five bay Quadrapower antenna with deicing	994-7625-002
TAZ-38UR five bay Quadrapower antenna with radomes	994-7625-003
TAZ-45U six bay Quadrapower antenna	994-7626-001
TAZ-45U six bay Quadrapower antenna with deicing	994-7626-002
TAZ-45UR six bay Quadrapower antenna with radomes	994-7626-003

Note: One bay and two bay UHF Quadrapower antennas and VHF Quadrapower antennas are available on request. All antennas are F.O.B. Harris' antenna facility, Palmyra, Missouri.

Options and Accessories

Input Connectors:	Dual 6-1/8" , 8-3/16" , 9-3/16" or waveguide.
Input Power:	Up to 150 kilowatts.
Rosemount Ice Warning System:	Consists of Model 871CB1 Ice Detector and Model 524B1 Controller.



HARRIS

BATWING VHF Television Antenna

- Field tested and proven designs
- Multi-channel operation available
- Factory assembly
- Copper feed lines
- Galvanized mast and radiators
- Rugged mechanical design
- Conservative electrical design

The Harris VHF Batwing antenna has been widely used in television broadcasting service for many years. This well-proven design provides broadcasters with fine performance and long, reliable service.

The antenna consists of four "Batwing" radiators per bay, which are bolted to a cylindrical mast section. The antenna is engineered for top mounting on a tower, but smaller antennas are frequently side mounted for standby antenna service.

The radiators and the mast are hot-dipped galvanized steel, and corrosion-resistant components are used throughout to prevent electrical and mechanical degradation. The radiators are solidly bolted to the mast, which is ground potential for maximum lightning protection.

Patterns

The Batwing antenna normally provides a circular, or omnidirectional, radiation pattern in the horizontal plane. For special locations, the antenna design can be customized to provide a peanut, or figure-eight, pattern. A notch diplexer and phasing equipment are required for these special patterns.

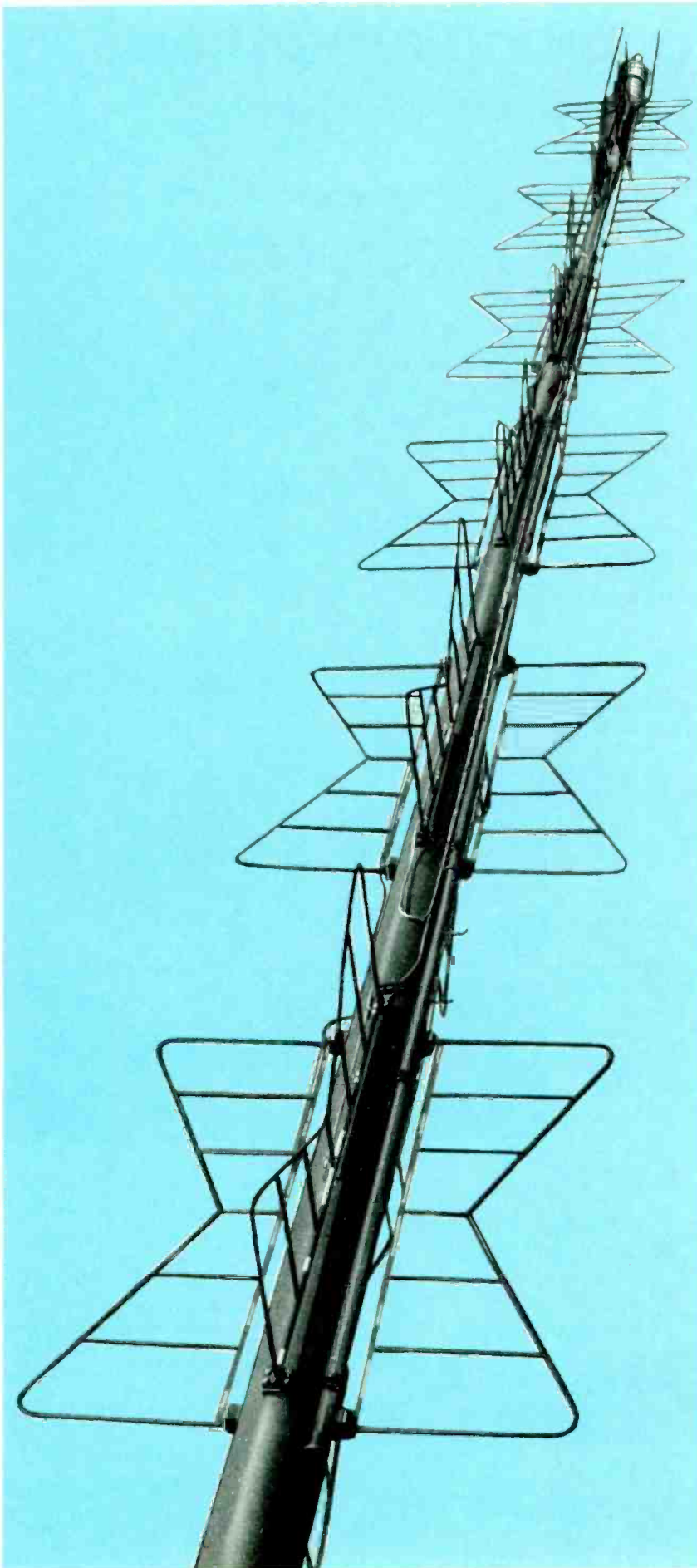

Harris VHF-TV Batwing antennas . . . field tested and proven designs

Vertical plane patterns can be provided with beam tilt and null fill to satisfy nearly all special requirements.

Multi-Channel Operation

The inherently wide bandwidth and high power handling capability of the Batwing antenna make it suitable for transmitting two multiplexed television signals within the same channel group.

Input Connections

The Harris Batwing antenna is normally fed by two 3 1/8", 50-ohm transmission lines. The 90° phasing between lines is normally provided by a hybrid diplexer that is available as an accessory.

As an option, the antenna can be equipped to accept a signal from a single transmission line. In this case, a notch diplexer is required for combining the aural and visual transmitter signals.

Deicers

Batwing antennas are not severely affected by moderate amounts of icing because of the inherently low feed point impedance. Deicers are recommended, however, in areas where severe icing may be expected.

Assembly and Testing

Each Batwing antenna is completely assembled and tested at the Harris antenna facility in Palmyra, Missouri. After assembly and test, the antenna may be partially disassembled to facilitate shipping; however, shorter antennas may be shipped in one piece. The factory assembly and testing minimize installation time required after delivery to the antenna site.

Filing Information

Complete specifications and filing information are available on request. Harris antenna engineers are also available by telephone to discuss your specific antenna requirements.

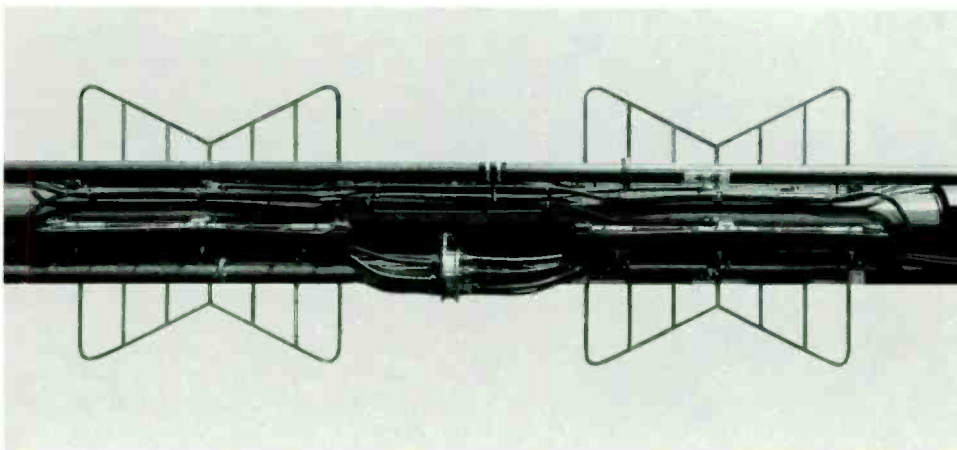
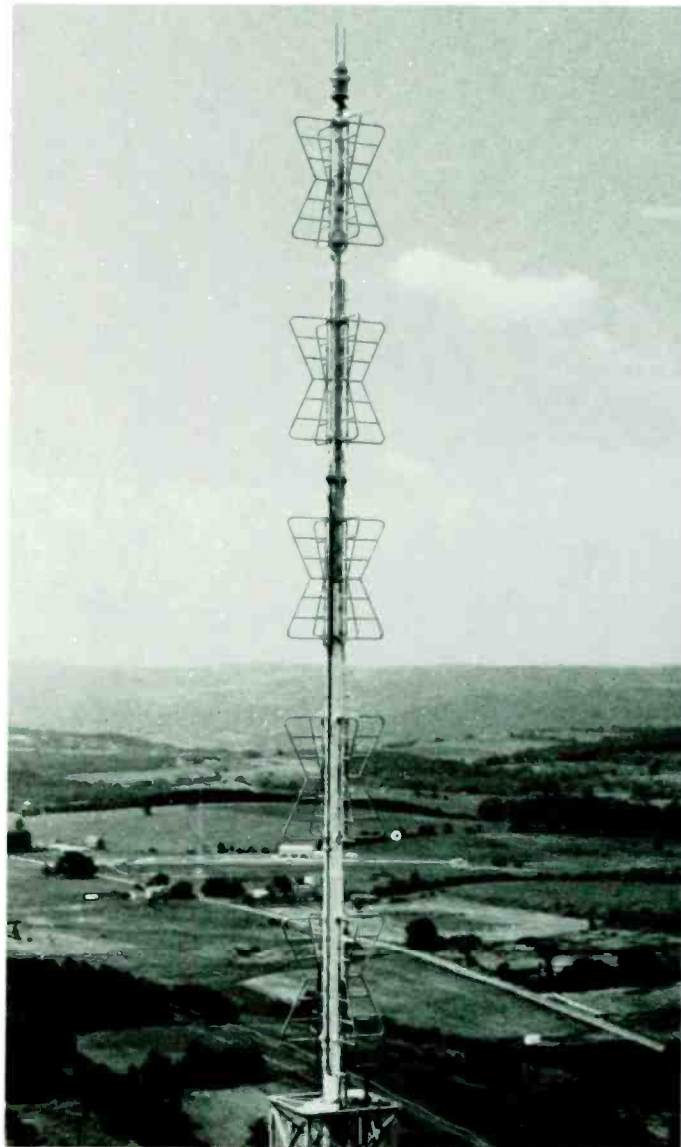

(Above) Channel 5, five-bay Batwing antenna. (At left) Batwing transmitting antenna junction box assembly.

VHF Batwing antenna specifications

Channels 2 - 6

Antenna Type	Power Gain Maximum		Input Power(e)		Antenna Height H ft(c)	Rad. Center R ft(d)	Moment ft-lbs(a)	Shear lbs(a)	Wt. lbs.
	Ratio	dB	kW	dBk					
CHANNEL 2									
TAB-1L	1.0	0	22.0	13.42	29.00	18.75	16,700	1,410	1,850
TAB-3L	2.9	4.62	66.0	18.20	53.00	24.83	63,800	3,250	4,550
TAB-4L	3.8	5.80	88.0	19.44	70.00	33.29	123,700	4,930	7,770
TAB-5L	5.1	7.08	110.0	20.41	88.33	43.08	204,700	6,610	11,250
TAB-6L	6.0	7.78	120.0	20.79	105.00	51.21	317,100	8,470	15,700
CHANNEL 3									
TAB-1L	1.0	0	20.0	13.01	29.00	18.75	16,700	1,410	1,850
TAB-3L	3.1	4.91	60.0	17.78	53.00	24.83	63,800	3,250	4,550
TAB-4L	3.9	5.91	80.0	19.03	70.00	33.29	123,700	4,930	7,700
TAB-5L	5.3	7.24	100.0	20.00	88.33	43.08	204,700	6,610	11,250
TAB-6L	6.2	7.92	118.0	20.72	105.00	51.21	317,100	8,470	15,700
CHANNEL 4									
TAB-1L	1.0	0	19.5	12.90	27.00	17.73	14,100	1,060	1,350
TAB-3L	2.9	4.62	59.0	17.71	44.00	20.28	44,000	2,680	3,250
TAB-4L	4.0	6.02	78.0	18.92	59.00	27.88	86,000	3,880	5,300
TAB-5L	4.9	6.90	97.0	19.87	73.33	35.15	137,600	5,130	7,450
TAB-6L	6.1	7.85	112.0	20.49	87.00	41.71	205,000	6,610	11,350
CHANNEL 5									
TAB-1L	1.0	0	19.0	12.79	27.00	17.73	14,100	1,060	1,350
TAB-3L	3.1	4.91	57.0	17.56	44.00	20.28	44,000	2,680	3,250
TAB-4L	4.2	6.23	76.0	18.81	59.00	27.88	86,000	3,880	5,300
TAB-5L	5.3	7.24	95.0	19.78	73.33	35.15	137,600	5,130	7,450
TAB-6L	6.5	8.13	106.0	20.25	87.00	41.71	205,000	6,610	11,350
CHANNEL 6									
TAB-1L	1.0	0	18.0	12.55	27.00	17.73	14,100	1,060	1,350
TAB-3L	3.3	5.19	54.0	17.32	44.00	20.28	44,000	2,680	3,250
TAB-4L	4.4	6.44	72.0	18.57	59.00	27.88	86,000	3,880	5,300
TAB-5L	5.4	7.32	90.0	19.54	73.33	35.15	137,600	5,130	7,450
TAB-6L	6.6	8.20	102.0	20.09	87.00	41.71	205,000	6,610	11,350

Specifications subject to change without notice.

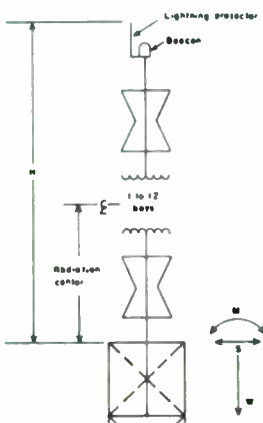

BATWING NOTES

- Gains shown in these tables are for antennas having no null fill or beam tilt. Contoured patterns are available on request.
- Pattern horizontal circularity for all Batwings is ± 2 dB or better.
- Batwing antennas are normally furnished with $\frac{1}{8}$ " copper feed lines.
- Input connections are dual $3\frac{1}{8}$ " EIA flanged 50-ohm line. Other feed line arrangements are available on request.

KEY TO DATA

- (a) Antennas are designed in accordance with the American Institute of Steel Construction code.

The loading data shown in the table is based on a wind pressure of 50 lbs. per sq. ft. acting normal to flat surfaces. Loading data includes windload effects for beacon (not provided by Harris), and also bury sections if not flange mounted.

- (b) For all antennas listed, installed above 500 feet AAT, the relative field at the Radio Horizon is greater than 90% of max., and thus, per FCC 73.684 (c) 1, need not be given separately.
- (c) H: Height above tower top including 4.00 ft. of lightning protector.
- (d) R: Height of radiation center above tower top.
- (e) Peak visual power rating: For average black level power including 20% aural, multiply by .8.
- (f) Data shown in these tables is typical. Specific data may be obtained on request from Harris.

VHF Batwing antenna specifications

Channels 7 - 13

Antenna Type	Power Gain Maximum		Input Power(e)		Antenna Height H ft(c)	Rad. Center R ft(d)	Moment ft-lbs(a)	Shear lbs(a)	Wt. lbs.
	Ratio	dB	kW	dBk					
CHANNEL 7									
TAB-2H	1.9	2.79	26.0	14.15	20.00	9.63	6,000	700	750
TAB-6H	6.2	7.92	77.0	18.86	41.25	19.17	28,250	1,900	2,200
TAB-12H	11.9	10.75	77.0	18.86	78.00	37.67	137,000	4,350	9,100
CHANNEL 8									
TAB-2H	1.9	2.79	25.0	13.98	20.00	9.63	6,000	700	750
TAB-6H	6.3	7.99	75.0	18.75	41.25	19.17	28,250	1,900	2,200
TAB-12H	12.2	10.86	75.0	18.75	78.00	37.67	137,000	4,350	9,100
CHANNEL 9									
TAB-2H	2.0	3.01	24.0	13.80	20.00	9.63	6,000	700	750
TAB-6H	6.7	8.26	72.0	18.57	41.25	19.17	28,250	1,900	2,200
TAB-12H	12.6	11.00	72.0	18.57	78.00	37.67	137,000	4,350	9,100
CHANNEL 10									
TAB-2H	2.0	3.01	23.0	13.62	20.00	9.63	6,000	700	750
TAB-6H	6.7	8.26	70.0	18.45	41.25	19.17	28,250	1,900	2,200
TAB-12H	12.9	11.11	70.0	18.45	78.00	37.67	137,000	4,350	9,100
CHANNEL 11									
TAB-2H	2.0	3.01	23.0	13.62	20.00	9.63	6,000	700	750
TAB-6H	6.8	8.33	70.0	18.45	41.25	19.17	28,250	1,900	2,200
TAB-12H	12.6	11.00	70.0	18.45	78.00	37.67	137,000	4,350	9,100
CHANNEL 12									
TAB-2H	2.0	3.01	23.0	13.62	20.00	9.63	6,000	700	750
TAB-6H	6.8	8.33	70.0	18.45	41.25	19.17	28,250	1,900	2,200
TAB-12H	12.3	10.90	70.0	18.45	78.00	37.67	137,000	4,350	9,100
CHANNEL 13									
TAB-2H	1.9	2.79	23.0	13.62	20.00	9.63	6,000	700	750
TAB-6H	6.9	8.39	70.0	18.45	41.25	19.17	28,250	1,900	2,200
TAB-12H	12.2	10.86	70.0	18.45	78.00	37.67	137,000	4,350	9,100

Specifications subject to change without notice.

(g) Antennas are delivered completely assembled to the customer F.O.B. Harris Test Range and may be partially disassembled to facilitate transportation. Re-assembly of the antenna at installation site is the responsibility of the customer.

Supporting structure necessary to support antenna during re-assembly and test must be supplied by the customer. Construction prints of the supporting structure will be supplied by the company.

(h) The beacon lighting cable to the bottom of the antenna is included.

(i) Antenna will be supplied with a coat of protective primer only. Customer to paint color required at time of installation.

(j) All mechanical parts are fabricated from hot dipped galvanized steel or other materials that resist corrosion such as copper, brass, bronze and stainless steel.

(k) Demonstration of pattern test at the test range at extra cost.

(l) Nominal amounts of null fill and beam tilt available at no increase in price.

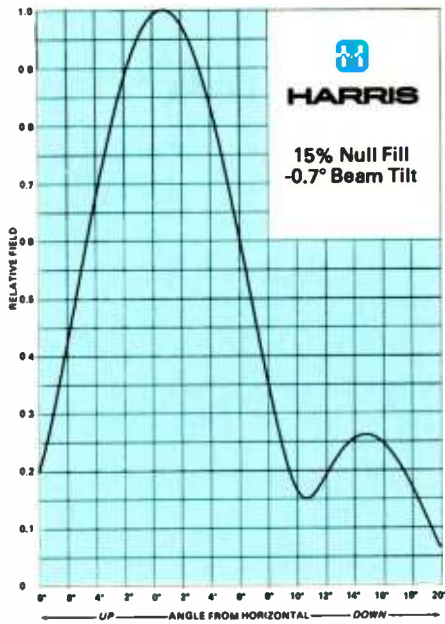

TAB-6L

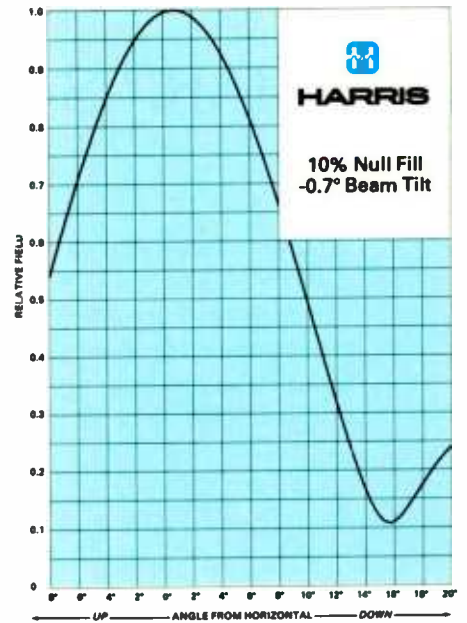

TAB-4L

TAB-12H
TAB-6H
TAB-6L
TAB-4L

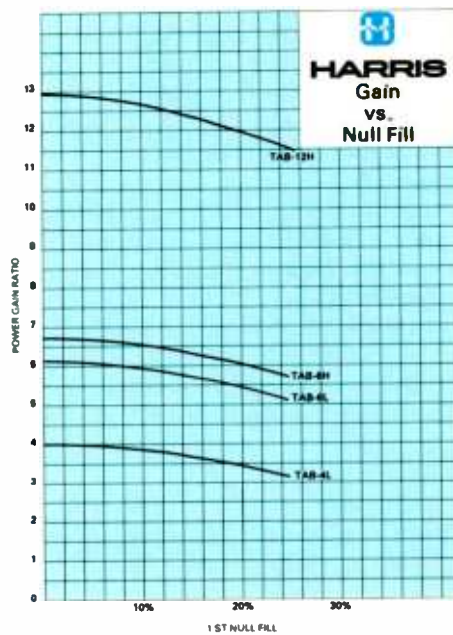

TYPICAL
CALCULATED
VERTICAL
FIELD
PATTERNS

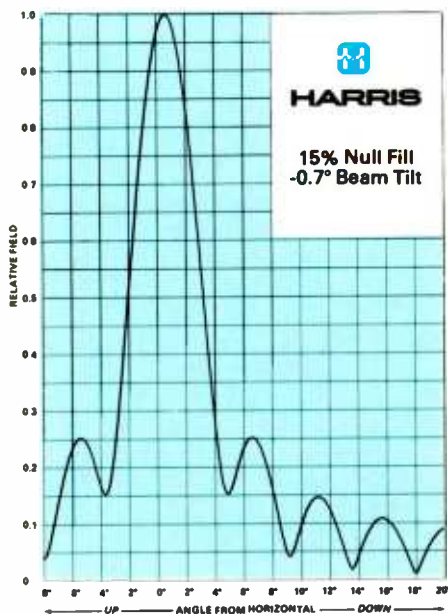

TAB-12H

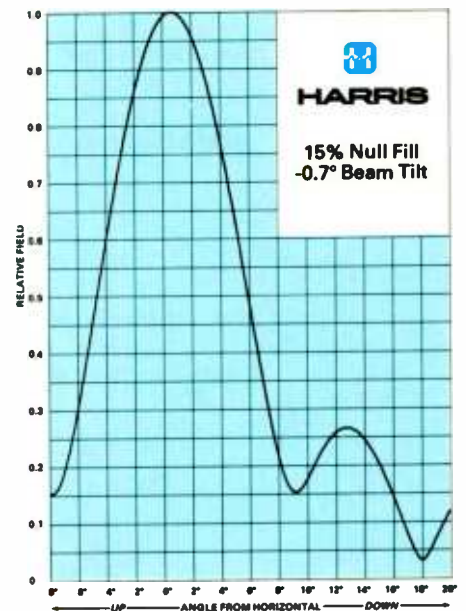

TAB-6H

HARRIS VHF BATWING ANTENNA

Electrical Specifications

Channel Range: 54-88 MHz (FCC Ch. 2-6); 174-216 MHz (FCC Ch. 7-13).	Input VSWR:
Power Gain: 1 to 6, Ch. 2-6; 1 to 12, Ch. 7-13.	Visual Carrier: 1.05 to 1.
Input Connector: Dual 3 $\frac{1}{8}$ "', 50 ohm.	Color Subcarrier: 1.08 to 1.
Input Power Rating: 102 to 120 kW, TAB-6L. 70 to 77 kW, TAB-12H.	Rest of Channel: 1.10 to 1.
	Circularity: ± 2 dB.
	Deicer Power: 3 kW per bay, Ch. 2, 3; 2 kW per bay, Ch. 4-6; 1 kW per bay, Ch. 7-13; 208/ 240 VAC, 60 Hz.

Specifications subject to change without notice.

Ordering Information

When ordering Harris Batwing antennas, please specify channel number, pattern, beam tilt and null fill. Antennas supplied with lightning protector, beacon cable and prime coating. Assistance with antenna assembly and ground test also supplied. Beacon, painting and ground support structures are not included.

TAB-1L single bay Batwing antenna, Ch. 2-6994-7602-001
TAB-3L three bay Batwing antenna, Ch. 2-6994-7604-001
TAB-4L four bay Batwing antenna, Ch. 2-6994-7605-001
TAB-5L five bay Batwing antenna, Ch. 2-6994-7606-001
TAB-6L six bay Batwing antenna, Ch. 2-6994-7607-001
TAB-2H two bay Batwing antenna, Ch. 7-13994-7603-001
TAB-6H six bay Batwing antenna, Ch. 7-13994-7608-001
TAB-12H twelve bay Batwing antenna, Ch. 7-13994-7609-001

Note: Two bay antennas for Ch. 2-6 available on request. One, four, eight and ten bay antennas for Ch. 7-13 available on request. All antennas are F.O.B. Harris' antenna facility, Palmyra, Missouri.

Options and Accessories

Rosemount Ice Warning System:	Consists of Model 871CB1 Ice Detector and Model 425B1 Controller.
Input Connector:	Single line input.
Pattern:	Peanut, or figure-eight
Hybrid Diplexer:	26 kW, Ch. 2-6. 66 kW, Ch. 2-6. 15 kW, Ch. 7-13. 55 kW, Ch. 7-13.

Test Range Pattern Measurements

Single Bay Rental Antennas Available on Request



HARRIS

TRAVELING WAVE HELICAL TV ANTENNA

- High quality performance
- Simple, reliable, economical design
- Maximum pattern versatility
- Low VSWR
- Low impedance, non-resonant radiating element
- Maximum lightning protection
- Superior pattern stability under adverse wind conditions
- Easy to de-ice—no internal heaters or radomes required
- Actual factory measurements of horizontal and vertical patterns provided for each antenna
- Heavy duty mechanical construction
- Low maintenance costs

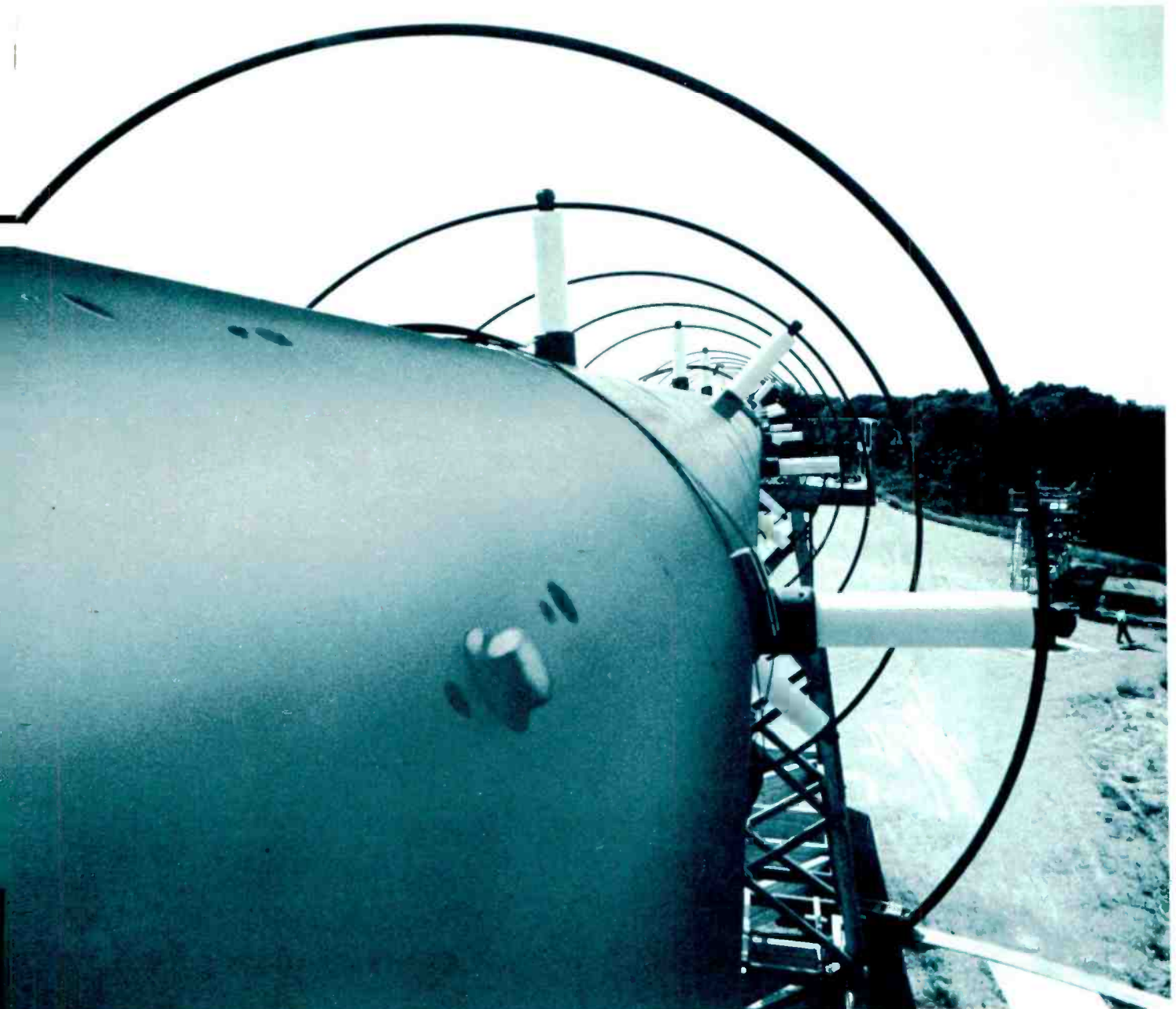

The Harris traveling wave Helical television transmitting antenna is noted for its uncomplicated design that greatly enhances reliability, while providing maximum pattern versatility and stability. The antenna employs the traveling-wave principle, which results in a smoothly contoured, low sideband single bay pattern, and excellent VSWR characteristics. VSWR is typically 1.08 or better across the band, 1.05 or better at visual carrier. When used in a multi-bay array, the Helical can provide an infinite variety of patterns. Typical VHF high band vertical and horizontal patterns are shown below.

HELICAL DESIGN. The traveling wave Helical antenna consists of a right-and-left-hand helix wound around a conducting mast with the feed point at the center. The antenna uses the traveling-wave principle to excite a large portion of the aperture from a single feed point on each bay. The RF current, because of the radiation loss, is attenuated as it approaches the ends of the conductor. Since only a small amount of energy remains at this point, the ends of the helices may be grounded to the mast, rather than terminated, with negligible effects on performance.

The helix is designed to meet certain dimensional requirements as necessitated by the frequency so that the currents at like points in each of its turns are in phase. Thus, as the current progresses from turn to turn, it is delayed for each turn an amount of time equal to that consumed by an integral number of cycles. Each turn is made an integral number of wavelengths in helical circumference as measured at the velocity of propagation along the helix. Most frequently, two wave-lengths per turn are used.

The spacing of the helix radiating element from the steel mast is such that an appreciable amount of radiation loss per turn oc-

curs along the helix. The design objective for this radiation loss is about 4 dB per turn. Since there are approximately six turns on the helix, the energy remaining at the ends is down 24 dB. The total length of the helix has been adjusted commensurate with the loss per turn so that resonance effects due to end reflections are avoided. This reduces partial clover-leafing of the horizontal pattern to meet horizontal-pattern requirements.

LOW-IMPEDANCE, NON-RESONANT RADIATING ELEMENT. A right- and left-hand helix are used in each section to effectively cancel the vertically polarized radiation components due to the helix pitch angle. The two helices are placed end to end and are fed by a common feed point at their junction located at the section's center. This reduces the feed-point impedance to approximately 100 ohms. This low impedance, and consequent low RF voltages, minimizes dielectric breakdown problems, and results in an antenna design inherently immune to moderate icing conditions. This basic design characteristic, coupled with the fact that the Helical antenna is fundamentally a non-resonant circuit, contributes to reliable, stable performance under extreme weather conditions. In addition, each feed point is provided with a shorted quarter-wave stub that prevents coupling lightning surges into the transmission line and the transmitter.

ANTENNA PATTERNS. Since the gains achieved with most Helical antennas are usually high, the need for pattern contouring must be carefully considered. The Helical is designed especially for ease of contouring, and almost any pattern desired is obtainable. Also, beam tilt and null fill are tailored to the customer's specific requirements, and simple modifications of both may be accomplished in the field to compensate for shifting population densities. Each Helical is tested at the Harris

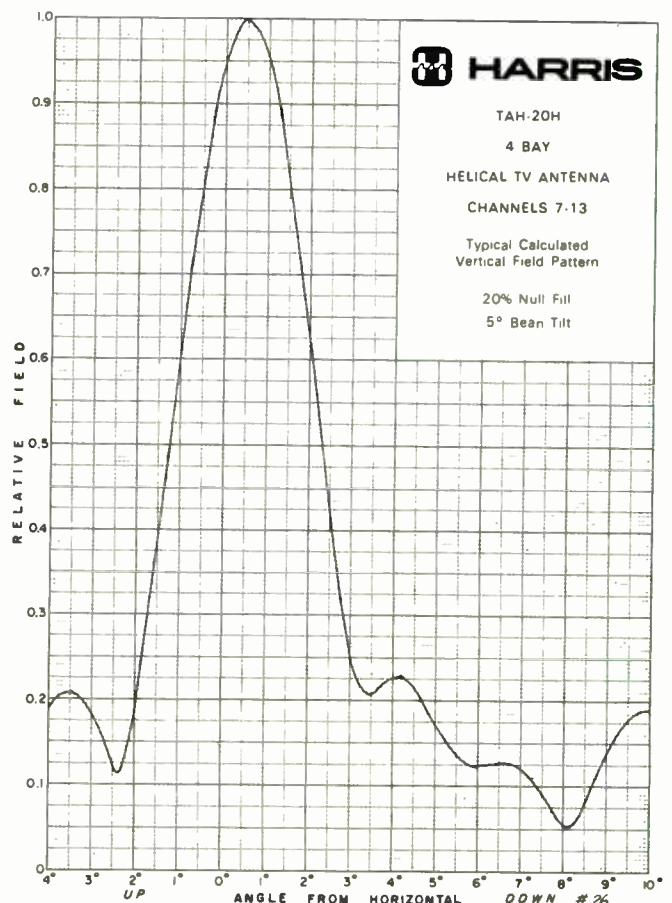
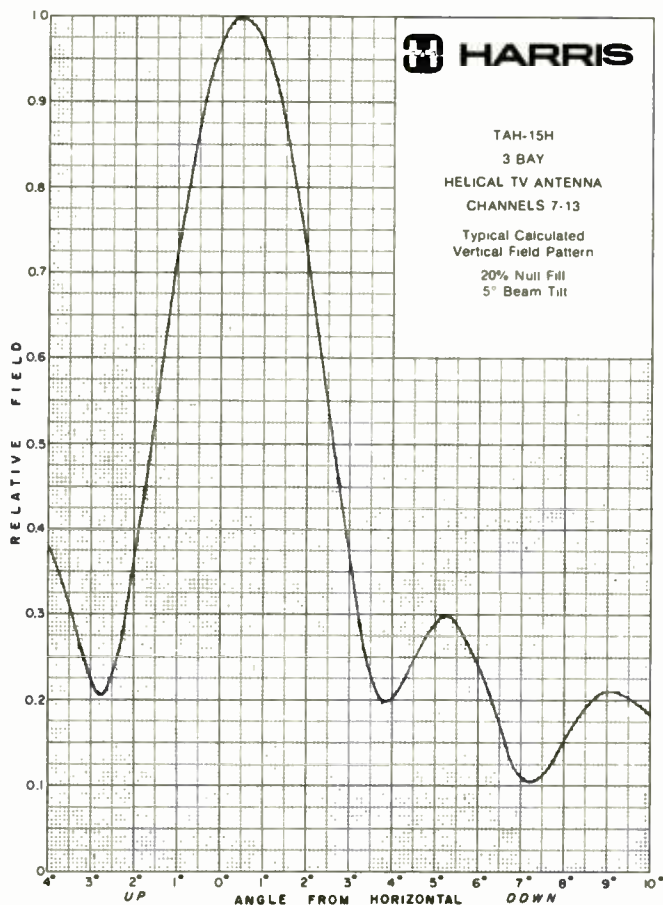

TV antenna test range before shipment, and the customer is furnished the measured horizontal and vertical patterns.

BEAM TILTING. Simple beam tilting without appreciable null fill-in may be achieved on the Helical antenna by introducing phase shift between successive sections. This is accomplished by using a different length of feed line between the power divider and feed elbow of each section on a VHF Helical. Simple beam tilt in the range of zero-to-one degree does not basically change the vertical pattern shape as compared to a standard vertical pattern. Nor do simple beam tilts of this order reduce the peak-power gain appreciably.

NULL FILL. Null fill-in is often desirable and may be obtained by proper power distribution and current phase in each bay. Large degrees of null fill-in will reduce the antenna gain. However, the advantage of a higher signal level over the close-in area will often justify this loss in gain.

EASY DE-ICING. De-icing is accomplished by a low-voltage, high current fed through the radiating helix—no internal heaters or radomes are required. This current is supplied by a thermostatically controlled transformer (for each bay), which is included when de-icing is ordered. The dissipation is a nominal 1.5 watts per square inch of helix element surface. Because of the relatively small area, only 2.5 kilowatts of power per section is required for effective de-icing on VHF high band Helicals.

HEAVY-DUTY CONSTRUCTION. All Harris traveling wave Helical antennas are of heavy-duty construction and are designed to operate in areas where heavy winds and/or heavy ice

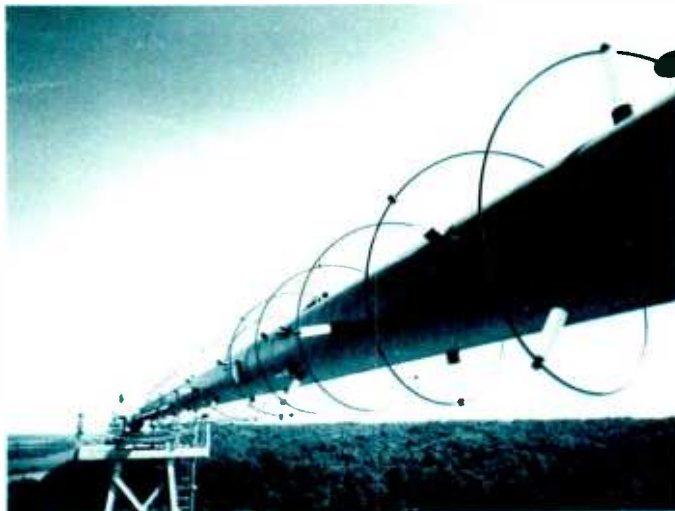

loading may be encountered. The extra stiffness and strength of the Helical mast minimizes antenna sway, and enables the Helical to withstand a pressure on projected flat surfaces of 50 pounds per square feet of windloading—which corresponds to an actual wind velocity of 112 miles per hour. All hardware is weather resistant stainless steel or zinc plated.

COMPLETE MECHANICAL ACCESS, LOW MAINTENANCE COSTS. All radiating elements are totally accessible on the outside of the mast, and pole steps are provided on the mast for easy inspection and maintenance. Due to the convenient element accessibility and the simplicity of the antenna design, maintenance costs are typically very low.

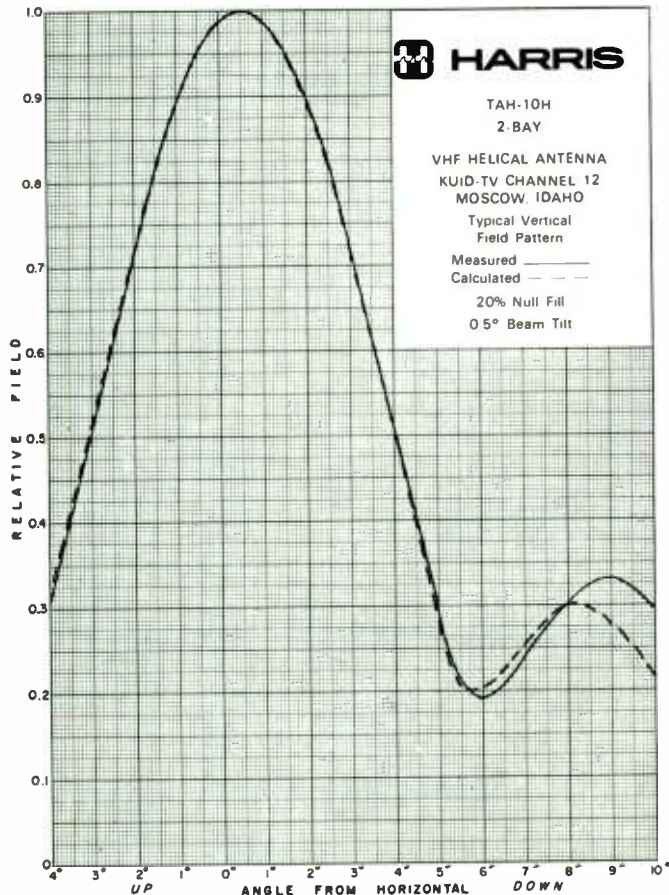

MEASURED HORIZONTAL FIELD PATTERN
TAH-10H VHF HELICAL ANTENNA
KUID-TV CHANNEL 12
MOSCOW, IDAHO

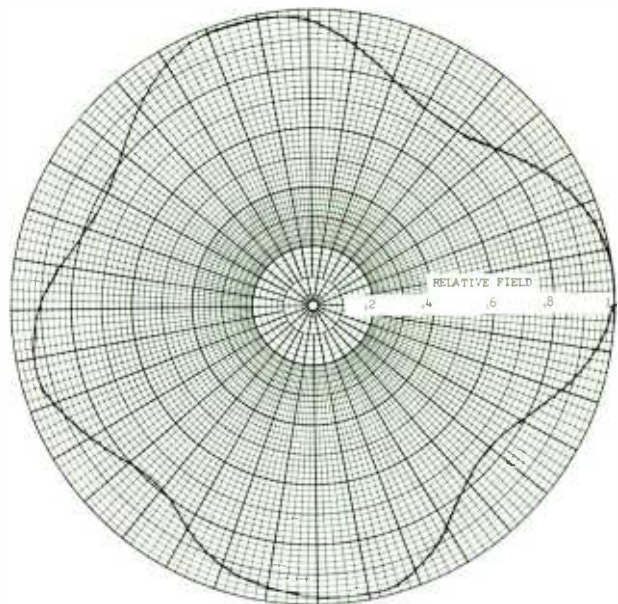

measured Circularity
± 1.26 dB from
average circle

HELICAL VHF SPECIFICATIONS CHANNELS 7-13

For information on VHF low band and UHF Helicals contact Harris

TAH-10H 2 Sections
TAH-15H 3 Sections
TAH-20H 4 Sections

Antenna Type	Null Fill	Antenna Height H ft. (c)	Rad. Center R ft. (d)	Input Power (e)		Power Gain Maximum (b)		M Moment ft.-lbs. (a)	S Shear lbs. (a)	W Weight lbs.
				kW	dBk	Ratio	dB			
CHANNEL 7										
TAH-10H	20%	67.67	35.51	56	17.48	9.0	9.54	159.540	4.950	7.500
TAH-15H	20%	97.25	53.74	67	18.26	12.6	11.00	330.480	7.030	13.000
TAH-15H	15%	97.25	50.88	72	18.57	13.5	11.30	330.480	7.030	13.000
TAH-20H	15%	127.25	67.90	123	20.90	17.4	12.41	587.650	9.250	19.500
CHANNEL 8										
TAH-10H	20%	67.67	35.51	55	17.40	9.2	9.64	159.540	4.950	7.500
TAH-15H	20%	97.25	53.74	66	18.20	13.0	11.14	330.480	7.030	13.000
TAH-15H	15%	97.25	50.88	71	18.51	14.0	11.46	330.480	7.030	13.000
TAH-20H	15%	127.25	67.90	121	20.83	18.0	12.55	587.650	9.250	19.500
CHANNEL 9										
TAH-10H	20%	63.33	33.24	54	17.32	8.9	9.49	131.410	4.310	6.500
TAH-15H	20%	91.25	50.25	65	18.13	12.5	10.97	272.610	6.190	11.000
TAH-15H	15%	91.25	47.61	70	18.45	13.5	11.30	272.610	6.190	11.000
TAH-20H	15%	119.25	63.70	118	20.72	17.4	12.41	472.450	8.140	17.800
CHANNEL 10										
TAH-10H	20%	63.33	33.24	53	17.24	9.2	9.64	131.410	4.310	6.500
TAH-15H	20%	91.25	50.25	64	18.06	12.9	11.11	272.610	6.190	11.000
TAH-15H	15%	91.25	47.61	69	18.39	13.9	11.43	272.610	6.190	11.000
TAH-20H	15%	119.25	63.70	115	20.61	17.4	12.41	472.450	8.140	17.800
CHANNEL 11										
TAH-10H	20%	63.33	33.24	52	17.16	9.4	9.73	131.410	4.310	6.500
TAH-15H	20%	91.25	50.25	63	17.99	13.3	11.24	272.610	6.190	11.000
TAH-15H	15%	91.25	47.61	68	18.33	14.3	11.55	272.610	6.190	11.000
TAH-20H	15%	119.25	63.70	113	20.53	17.4	12.41	472.450	8.140	17.800
CHANNEL 12										
TAH-10H	20%	59.25	30.97	51	17.08	9.1	9.59	102.980	3.670	5.900
TAH-15H	20%	85.25	46.77	62	17.92	12.7	11.04	219.310	5.340	10.000
TAH-15H	15%	85.25	44.31	67	18.26	13.7	11.37	219.310	5.340	10.000
TAH-20H	15%	111.25	59.50	111	20.45	17.7	12.48	379.030	7.010	15.500
CHANNEL 13										
TAH-10H	20%	59.25	30.97	50	16.99	9.2	9.64	102.980	3.670	5.900
TAH-15H	20%	85.25	46.77	61	17.85	12.8	11.07	219.310	5.340	10.000
TAH-15H	15%	85.25	44.31	66	18.20	13.8	11.40	219.310	5.340	10.000
TAH-20H	15%	111.25	59.50	109	20.37	17.7	12.48	379.030	7.010	15.500

SPECIFICATIONS SUBJECT TO CHANGE WITHOUT NOTICE.

HELICAL NOTES:

- Gains shown in the tables: Antennas having 5° beam tilt and either 15% or 20% null fill. Other patterns available on request.
- Horizontal pattern circularity: ±1.5 dB or better.
- Input connections: Standard single 8 1/4" EIA flanged line. 50 ohm.

KEY TO DATA:

- The antennas are designed in accordance with the Uniform Building Code and the American National Standard of Building Code Requirements for Minimum Design Loads in Building and Other Structures (ANSI A58.1-1972). The loading data shown in the table is based on a wind pressure of 50 lbs. per sq. ft. acting normal to flat surfaces.
- For all antennas listed, installed above 500 feet AAT, the relative field at the Radio Horizon is greater than 90% of max. and thus, per FCC 73.684 (c) 1, need not be given separately.
- H: height above tower top including 4.00 ft. of lightning protector.
- R: height of radiation center above tower top.
- e. Peak visual power rating: For average black level power including 20% aural, multiply by .8.

- Data shown in these tables is typical. Specific data may be obtained on request from Harris Corporation, Broadcast Division.
- Antennas are delivered completely assembled to the customer F.O.B. Harris Test Range and at the seller's option may be partially disassembled to facilitate transportation. Re-assembly of the antenna at installation site is the responsibility of the customer. Supervision of re-assembly and impedance test can be supplied at the customer's request. Supporting structure necessary to support antenna during re-assembly and test must be supplied by the customer. Construction prints of the supporting structure will be supplied by the company.
- The beacon lighting cable to the bottom of the antenna is included.
- Antenna will be supplied with a coat of protective primer only. Customer to paint color required at time of installation.
- All mechanical parts are fabricated from hot dipped galvanized steel or other materials that resist corrosion such as copper, brass, bronze and stainless steel.
- Demonstration of pattern test at the test range available at extra cost.
- Supervision of installation and testing of antenna and transmission line at the customer's site is available at extra cost.
- Nominal amounts of null fill and beam tilt available at no increase in price.

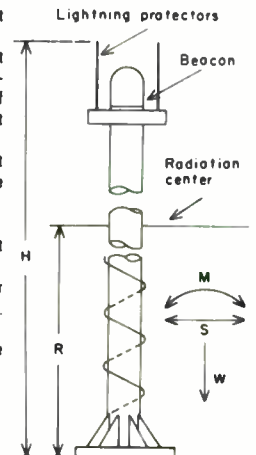

The Harris

TC-85

Computer Setup

Color Television Camera

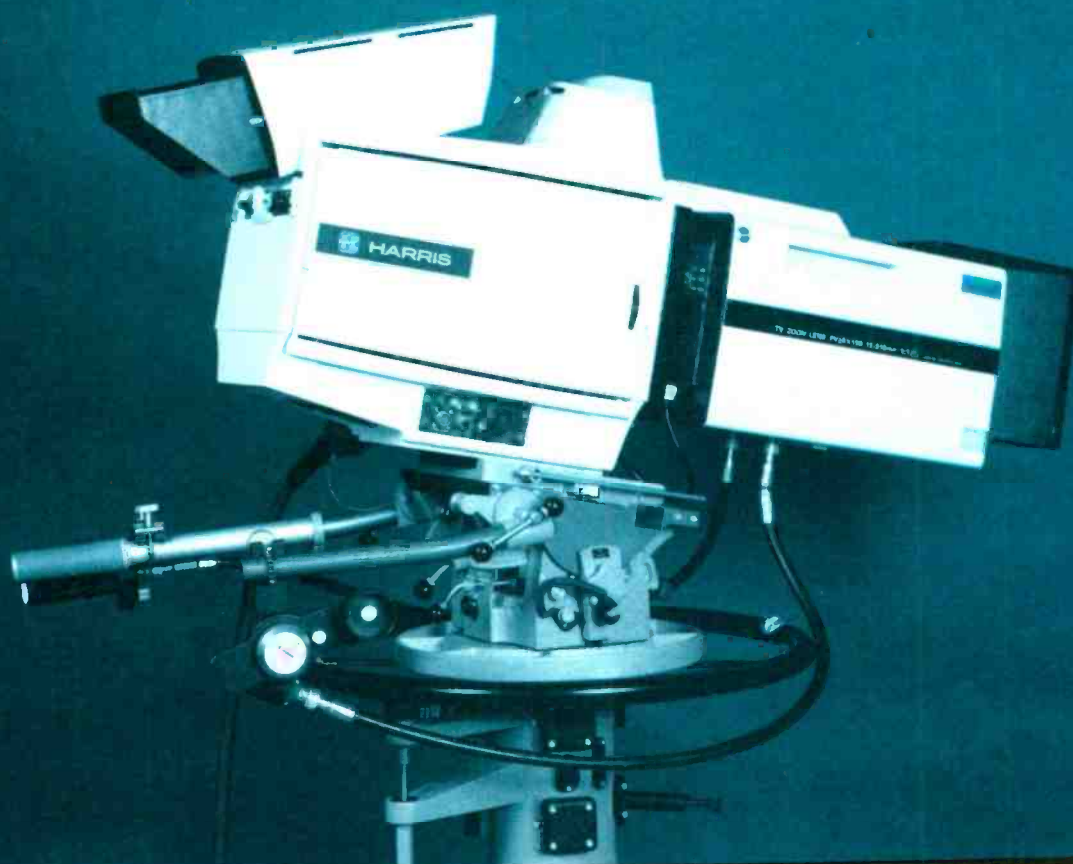

 **HARRIS**

HARRIS TC-85—the first studio camera

- An individual computer in each camera means high system reliability
- Computerized setup is fast and reliable...saves time, assures peak operating performance
- Stability of camera system provides controlled, repeatable performance
- Versatile add-on modular Triax cable system
- Excellent sensitivity allows noise-free pictures at very low light levels...ideal for remotes
- Highlight Handling system reduces comet-tailing 10:1
- Geometry corrector for outstanding geometry and registration

The TC-85 is a computer setup camera, with all operator functions controlled by the computer, and adjusted according to preset parameters. Each camera has a built-in independent computer to eliminate camera interdependence in multi-camera installations. This allows *simultaneous* camera setup to save you time, and means optimum, fail-safe performance by your TC-85s.

The computer, combined with the camera's inherent stability, allows camera operation by non-technical personnel, freeing your engineers for

other station duties. The computer eliminates even minor readjustments. At just the push of a button, consistent quality setups are achieved—camera matching is no longer a problem.

You'll find the TC-85 ideal for every face of your operation, from production, to news, to remotes.

PRODUCTION STUDIO. How many times have you seen talent and highly trained technicians waiting around for the cameras to be optimized for productions in multiple-set studios?

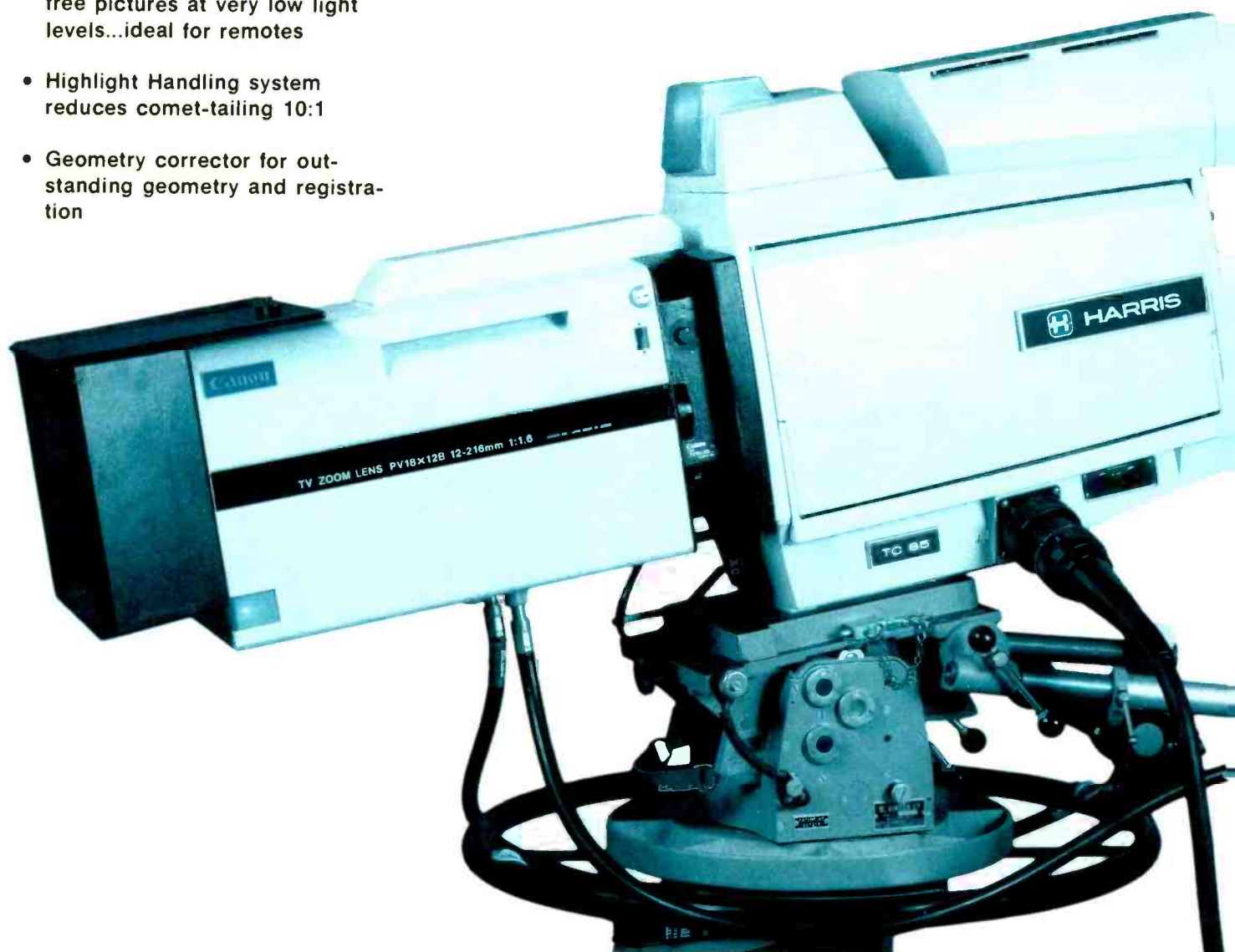

with a built-in setup computer

Now, with the TC-85, you can preset all of your cameras prior to production, according to the lighting on each set, in just a few minutes. This allows you to move the cameras freely from set to set, with virtually instantaneous setup of all cameras at once from their stored memories. Instead of the 30 minutes you would probably spend setting up 3 cameras each time you move, you spend only a few seconds with TC-85s!

NEWS. In many stations, production cameras also do double duty in the newsroom, and are regularly moved

from the production studio to the news area two or three times a day. Now, with the TC-85, you can continue your production work almost up until the time the news is ready to start. Then you can quickly wheel the cameras to your news center, push a button to recall the newsroom setup from the computers, and once again all of your cameras are ready to go in seconds. Think of the scheduling flexibility this will allow. And, if you currently use separate cameras for news and for production, you can conveniently cut down on the number of cameras required in your operation.

These are just a few typical situations in which the computer setup TC-85 camera helps you increase operational efficiency, with absolutely no compromise in picture quality.

A Detailed Look at the Computer Setup. As mentioned previously, each TC-85 incorporates a computer setup unit. This independent computer concept works to your advantage in multi-camera installations, where simultaneous camera setup saves you a lot of valuable time. It also provides added operational safety, for if one

As each TC-85 has an independent computer, camera interdependence is eliminated. This independent computer concept allows simultaneous multi-camera setup, and provides optimum reliability in multi-camera installations.



REMOTES. If you want to move outside the studio for a remote, the TC-85 does this very nicely, with its add-on Triax Cable system. And here again the computer setup makes things easier for you. Let's take a look at what advantages the camera offers you at, say, a football game.

First, the Triax system allows you to operate each camera up to one mile from the controls—on top of the stadium, for instance—without worrying about bulky Multicore cable, and without losing any of the cameras' superb picture quality or fine automatics.

Once in place, all cameras can be set up simultaneously by computer in a very few minutes, even if they are unattended. A quick color balance is accomplished automatically, in seconds, when the cameramen arrive at their posts—which need only be a couple of minutes before on-air time—and the TC-85s are ready to cover the action.

With cameras preset for direct sunlight and shadow conditions, as the play progresses up and down the field, the video operator merely selects the appropriate preset for optimum picture quality.

computer should fault, only one camera is affected, not all cameras.

Each adjustment performed by the computer is carried out to an extremely fine tolerance for the most consistent setup possible. The operator is not required to preset any controls prior to activation of the automatic setup.

Upon activation of the auto setup, a special test slide is automatically positioned in the optical path by a diascope (pattern projecting) lens. With a conventional zoom lens, an external chart may be used.

Complete setup for any number of cameras is accomplished in just a few minutes, depending on the required adjustments. In each camera, the computer starts its sequence by performing beam, focus and alignment adjustments. As the program continues, a coarse and then a fine registration, including size, centering, linearity, width, height and rotation are performed. The auto setup function also adjusts shading; pedestal and black balance; white balance; gamma and flare. Once the setup sequence is completed, the settings are stored in the computer



memory, and may be recalled as required.

A pre-production setup of all your cameras is completed in *less than 45 seconds*—including checking and adjustment of fine registration, black balance, white balance, gamma and flare. This is the first studio camera to offer a multi-camera quick check program that can be accomplished in less time than a standard commercial break!

Harris has also added a convenient feature to the setup unit which allows modification of computer settings to incorporate human judgment for that "artistic touch". Once the modifications have been made, they may automatically be reapplied in future setups.

The auto setup unit has a special store/recall memory for retention of four balance settings that may be required by different color temperatures or for artistic effects.

As a diagnostic tool, during the auto setup sequence, lighted indicators inform the operator of the setup status. If a function is not completed, a steady indication advises the location of the difficulty.

Should manual operation of the camera system be desired, simply push a button to disable the computer, and the manual setup panel can be used to perform all adjustable functions. In the manual mode, all setup controls are available simultaneously.

For multiple-camera installations, several convenient front panel mounting configurations are available, and external inputs are provided for initiating complete or pre-production setups for all cameras simultaneously.

TC-85 Performance and Versatility. Color fidelity and picture integrity are of the highest quality in the TC-85—and the camera's versatility is unmatched.

With the TC-85 you get the widest selection of operating modes and options of any studio camera in the industry: Triax or Multicore cable; accommodation of all types of pickup tubes, including Diode Gun Plumbicons® and Saticons®*; and accommodation of all lenses designed for the 25mm format, from the largest 42:1 zoom to 10:1 zoom, or special effects lenses. Tube type changes can be accomplished easily, and Triax added at any time, in the field.

This advanced camera provides high resolution, with low lag; high sensitivity; a master gamma contrast control; and Highlight Handling that virtually eliminates comet-tailing, to give you clean, sharp video even under the most severe lighting conditions.

The TC-85 camera head has a variety of features to simplify the job of the camera operator, including a tilting, detachable viewfinder; four tally lights; two-way signaling; and a script clip. The intercom system has two independent channels with a separate third channel for program audio.

With its computer setup, triax option, ease of operation, outstanding picture quality, low-light-level capability and unique flexibility, the TC-85 offers you a positive way to improve picture quality while holding the line on operating costs.

Some of the more important specific features of the TC-85 include:

Automatic Iris Control. Special weighting and frequency discriminating digital circuitry prevents specular reflections or momentary errors from upsetting an otherwise properly exposed picture. For example, overhead lighting in a wide studio shot will not affect picture quality.

Low-Noise Pre-Amplifiers. Low-light-level performance is enhanced by low-noise pre-amplifiers in conjunction with bias light, efficient prism optics and a master gain control. Master gain is switched from the computer operate panel in steps of +6, +12 and -6 dB, and has 6 dB of continuous vernier adjustment for up to +18 dB of gain. Pictures are quiet at ten foot-candles.

Master Gamma. The unique master gamma control on the computer operate panel allows you to increase or decrease contrast for better shots in difficult lighting conditions. Black level is unaffected by this control.

Electronic Color Temperature Correction. The camera computer selects lighting temperature equalization from four preset increments, without reduction of pickup tube face plate illumination.



An optional remote control panel connects to the computer unit of each camera, giving joystick control of MASTER BLACK and IRIS. Additional controls include paint pots, gain, balances (white or black), scenes and other necessary control functions. Four panels can be mounted side by side in a 10½" x 19" rack mount tray.

Aperture Correction. A two-line horizontal and vertical aperture corrector, employing comb filter, horizontal level-dependent-set, and noise coring techniques, provides a new dimension in picture quality. Some unique features of this system include fully gamma corrected detail enhancement to maintain resolution even in the low-light areas; and adjustable horizontal boost frequency and single control horizontal/vertical ratio adjustment. This means you can tailor the picture crispness to scene material.

Level Dependent Contours. A "Horizontal Level Dependent Contour" adjustment is employed which allows a pre-determined threshold above which horizontal contours are to be generated.

Black Level. A master black control with a unique electronic null provides the video operator with easy return to normal setup level.

Encoder Flexibility. The TC-85's integral encoder emphasizes more versatility for the video engineer. Output options include: individually selectable composite/non-composite signals; and front panel choice of color, mono or mono with burst.

The inserted sync is an AGC'd replica of the incoming signal from the station sync generator, so that the timing and controlled rise and fall times of the incoming sync signal are maintained. Burst flag is internally generated with controlled rise and fall times, and is timed from the leading edge of sync.

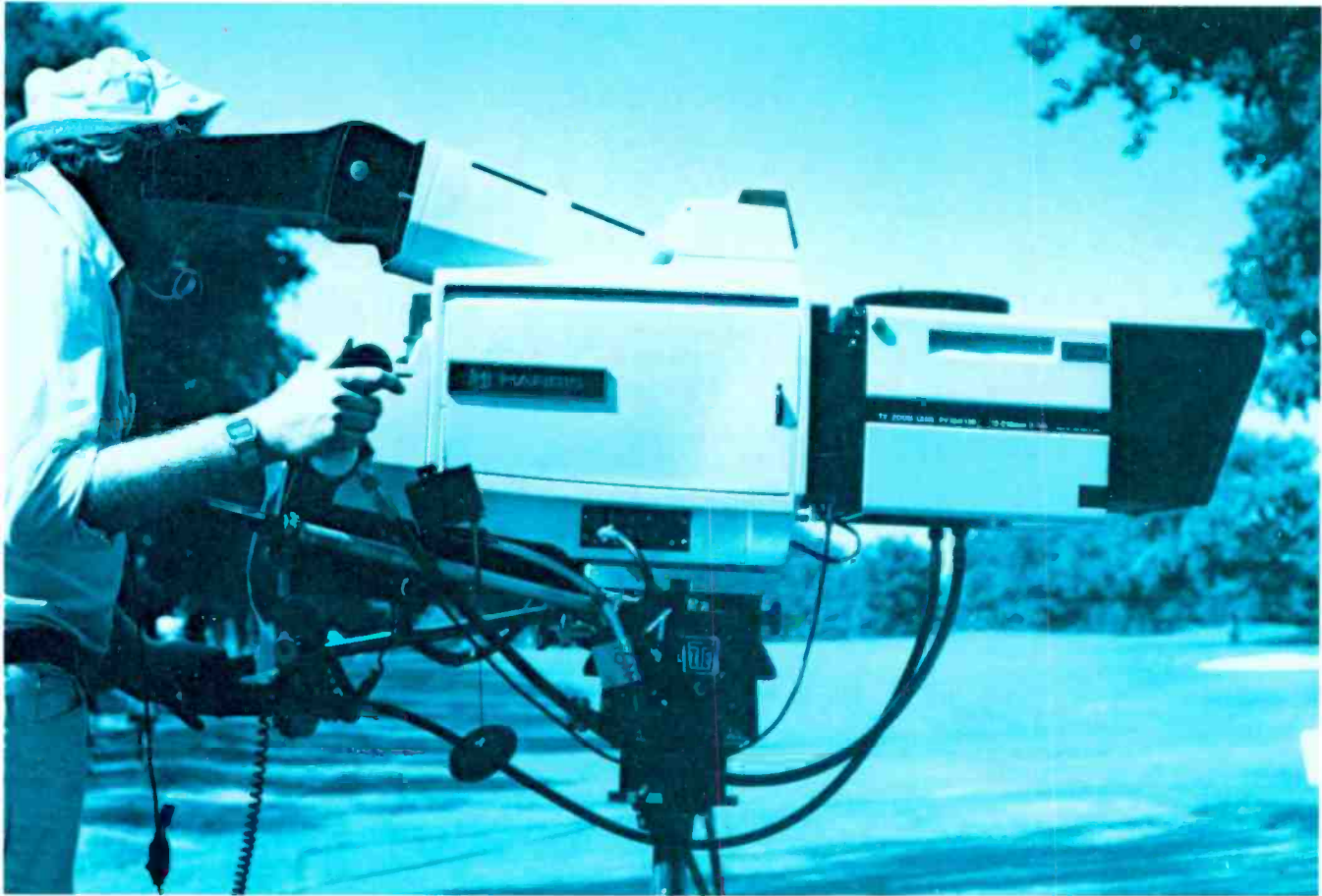

The TC-85, with Triax, is ideal for remotes such as sporting events, where studio-quality pictures are required.

The color bars are inserted before encoding for accurate verification of system performance, and are activated from the computer operate panel. Color bar options include: 75% bars or 75% bars with 100% white; full field or split field format. Color bars are produced by synchronous switching, with shaping controlled by active filters, to generate an exceptionally clean signal. CCIR standards are available.

Chroma Key. The TC-85 provides red, blue and green linear chroma key outputs for crisp, clean chroma keys even with Triax.

Special Effects. Various optical accessories such as fog-effect, diffusion, color and neutral density filters are available for use in the filter wheel to create special visual effects.

Sync Generator. The optional NTSC sync generator plugs into the processor frame of the CCU, and single cable synchronization of camera chains is simply and inexpensively accomplished. Sync, blanking and subcarrier outputs are available at the rear of the CCU

for driving other cameras or other video equipment.

Waveform and Picture Monitoring. The TC-85 provides the following waveform outputs: sequential R, B, G; superimposed R, B, G; R-G; B-G; and encoded output. These signals are routed to the waveform monitor by pushbutton control. Video signals to the picture monitor, also selected by pushbutton, are: R, B, G, -G; and encoded output.

High-Efficiency Switching Power Supply. The TC-85 owes much of its inherent stability to a power supply that uses high-efficiency switching regulators for both camera head and processor frame power. Switching frequency has been optimized to reduce weight while increasing efficiency to insure reliable, cool operation without need for forced air cooling. Size, weight and heat reductions for the switching supply, and a wide power requirement spec of 90-130/180-260 VAC, 47-63 Hz, make this supply ideal for operation in remote vans or under "brown-out" conditions.

Mechanical Integrity. The cast-aluminum TC-85 camera case and the 1/2-inch-thick aluminum optical mounting plate are combined in a solid, precision-machined and stress-relieved unit. This provides stable operation even under the most demanding field conditions. Computer-matched Harris, manufactured to Harris' specifications, and high-efficiency 4-element prism optics are precision-mounted in this integral unit to give the TC-85 a truly adjustment-free optical system.

Easy Servicing. With its designed-in reliability, the TC-85 will provide long-term, trouble-free operation with minimal servicing. When service is required, however, many useful features such as easy tube change, interchangeable pre-amps, readily accessible components and extensive use of test points and computer status lights have been included to cut maintenance time and costs.

For complete information on the TC-85 camera, contact your Harris TV District Manager or the Harris TV Sales Department in Quincy, Illinois (phone: 217/222-8200).

TC-85 Specifications

Electrical Scan Standards

EIA 525/60
CCIR 625/50

Power Requirements

Voltage 90 to 130V or 180 to 260V
Frequency 47 to 63Hz
Power Load 620W (exclusive of monitoring and options)

Inputs (Loop-Through, Bridging)

Sync 2 to 8 Vpp, negative
Blanking 2 to 8 Vpp, negative
Sub Carrier 1 to 4 Vpp
VF External
Video 1.0 Vpp Composite
External video or black burst with optional sync generator 1.0 Vpp

Outputs

Program Video .. 3 separately selectable for composite or non-composite
Chroma Key (R, B, G) ..0.7 Vpp across 75 ohms
Picture Monitor Video ..0.7 Vpp across 75 ohms
Waveform Monitor
Video0.7 Vpp across 75 ohms

Monitor Switching Facilities

Picture R, B, & G or —G separately or combined; color output (program)
Waveform R, B, G sequential or superimposed; R-G; B-G; color output (program)
Viewfinder R, B or G; Y video; external video

Sensitivity (Typical tubes)

Minimum Incident Light for full output with f1.6 lens6 fc
Incident Light for rated Signal/Noise at f2.8 80 fc
Signal/Noise Ratio
NTSC 52 dB
PAL 49 dB
(300 na green signal current; 1.0 gamma; bandwidth NTSC - 10 kHz to 4.2 MHz, PAL - 10 kHz to 5.5 MHz; masking, aperture & chroma - off)
Resolution (no aperture correction) 600 TV lines

Optical System

Color Separation ..Single unit prism with Integral Bias Light
Correction
Filters5 position filter wheel

Pick-Up Tubes

Red XQ2073R or XQ1073R
Blue XQ2070B or XQ1070B
Green XQ2070G or XQ1070G
ACT and Saticon tubes also available.

Registration Accuracy

Zone 1 (circle in center = 1.0 picture height) 0.05% of picture height
Zone 2 (circle in center = 1.0 picture width) 0.10% of picture height
Zone 3 (area outside Zone 2) ... 0.20% of picture height

Picture Geometry (including lens deviations)

Zone 1 0.5% or better
Zones 2 and 3 1.0% or better

Camera Cable Length

With 0.65 inch (17mm) diameter multi-core cable2000 ft. (610m)
With 1.1 inch (28mm) diameter multi-core cable3000 ft. (914m)
With 0.5 inch (13mm) diameter Triaxial Cable and optional Triax System 5000 ft. (1524m)
Over 5000 feet with larger diameter Triax Cable.

Operating Environment

Temperature
Camera Head -20 to +50 degrees C
Control Unit 0 to +50 degrees C
Humidity 0 to 95% RH
Altitude 0 to 10,000 ft. (3048m)

Shading Provisions

H & V sawtooth and parabola modulation. H & V sawtooth and parabola additive, for Bias Light.

Aperture Correction

Combined horizontal and vertical aperture correction derived from green with comb filtering and noise coring. Primary horizontal boost frequency 6 MHz, with adjustable 2.5 MHz secondary boost.

Gamma Correction

Master Gamma ... Continuously variable from linear to 0.35 independent of channel controls
R/B Gamma Vernier for tracking with Green

Intercom (RTS* compatible)

Camera Head & CCU Two headsets; Production, Engineering & Cue circuits
Party Line ... Accepts up to three party lines; selectable impedance matching
Program Audio Unbalanced bridging for cue audio

Signaling System

CCU to Camera Pushbutton flashes camera tally lights
Camera to CCU ... Pushbutton operates audible signal

Viewfinder

Screen Diagonal 6.1 in. (155mm)
Picture Brightness 0 to 150 ft. lamberts
Resolution better than 600 TV lines
Picture Timing AFC
Video Equalization ... Full Cable length
Controls Contrast, Brightness, Input Select and Response (flat, peak, notch)
Focal Length Indicator ... White bar top of picture

Mechanical

Camera Head (Less lens)
Height 19.5 in. (495 mm)
Width 10.5 in. (267 mm)
Depth 21 in. (533 mm)
Weight 85 lbs. (38 kg)

Processor Frame

Height 8.75 in. (222 mm)
Width 19 in. (483 mm)
Depth 15.5 in. (393 mm)
Weight 30 lbs.(14 kg)

Auto Setup Unit

Height 7.0 in. (178 mm)
Width 19 in. (483 mm)
Depth 16 in. (406 mm)
Weight 24 lbs. (10.9 kg)

Intercom Panel

Height 1.75 in. (44 mm)
Width 19 in. (483 mm)
Depth 7.25 in. (184 mm)
Weight 3 lbs. (1.4 kg)

Main Power Supply

Height 5.25 in. (133 mm)
Width 19 in. (483 mm)
Depth 20 in. (508 mm)
Weight 56 lbs. (25 kg)

Interconnect Panel

Height 7 in. (178 mm)
Width 19 in. (483 mm)
Depth 6 in. (142 mm)
Weight 8 lbs. (3.6 kg)

Options

Triax
Remote Control Panel with joystick control
NTSC Sync Generator Module
Vinyl Rain Cover

Accessories

All one-inch format zoom lenses from Angenieux, Canon, Fujinon, Rank and Schneider. Diascope models available.
Camera Cable, std. length 50 ft., 75 ft., 100 ft., 150 ft., 200 ft., 250 ft., 300 ft., 400 ft., 500 ft.
Triax Cable, std. length 100 ft., 250 ft., 500 ft., 1000 ft.
Headset, single or dual, carbon or dynamic mic
Cam Heads and Pedestals from Vinten, ITE, Quick-Set and TVP.

* Registered Trademark of RTS Systems, Inc.

SPECIFICATIONS SUBJECT TO CHANGE WITHOUT NOTICE.



HARRIS

HARRIS TRIAx CABLE SYSTEM

- Easily added to any TC-85 or TC-80 series camera in the field
- Extends range of camera operation up to 5,000 feet
- Maintains all operational features of Harris' TC-85/80 color cameras, including the ASU-85 computer setup unit
- Reduces camera cable costs for remotes
- Triax cable is easier to transport, install, repair and use on remotes
- Allows camera use in previously inconvenient locations for better coverage

The Harris Triax Cable System provides versatility and flexibility for field operation of Harris' TC-85 and TC-80 cameras. Easily added, with no special tools or camera modifications, the Triax system eliminates bulky, multi-conductor camera cable, and greatly extends the camera's range of operation.

Careful development of the Triax system has allowed Harris to offer this modern camera convenience with all of the basic TC-85 and TC-80 cameras' fine automatic features. The Triax system itself is fully automatic and has no operational controls of any kind. The system automatically compensates for any change of Triax cable length.

Additional Triax advantages include a significant cost reduction in long cable runs. And, since the system operates with smaller cable, not only will there be less weight to carry, but the cable will take up less space in storage. There will also be sizeable cost reductions in permanent cable installations such as sports arenas, college campuses or industrial complexes.

Harris' TC-85 and TC-80 cameras offer you proven triaxial operation as an option, without compromises in setup or operation—a significant advance in camera design.

OPERATION. The Harris Triax system multiplexes all the camera setup and operate controls from the camera control unit to the camera head. Viewfinder video is also multiplexed from the camera control unit to the camera head.

At the camera head, Red, Blue and Green video information is multiplexed to the camera control unit. Individual multiplexing of the Red, Blue and Green video produces independent R B G outputs at the camera control unit. This allows for clearer, sharper chroma keying.

Finally, two bi-directional channels of intercom are also multiplexed onto the triaxial cable. This allows two-way communication with the cameraman at a remote location.

SERVICEABILITY. The Harris Triax itself requires no periodic maintenance or adjustment with normal use. And, the Harris Triax is designed for ease of service, should service be required. Such features as modular construction, readily accessible components and built-in test points reduce service time.



**Harris Triax
camera control unit
interface drawer**

TYPICAL CABLE FOR USE WITH TRIAX SYSTEM

CABLE	OUTSIDE DIAMETER		TYPE	MANUFACTURER	JACKET	MAXIMUM CABLE LENGTH		WEIGHT	
	Inches	(mm)				Feet	(Meters)	Per 1,000 ft. in lbs.	Per 100m (in kg)
TRIAx	0.36	(9.1)	9267 TV20	Belden B/W	Neoprene or Hypelon	2,000	(610)	74	(54)
	0.52	(13.2)	9232 TV14	Belden B/W	Neoprene or Hypelon	5,000	(1,524)	135	(98)
	1.03	(26.2)	— —	Belden B/W	Neoprene or Vinyl	7,700	(2,347)	550	(401)
MULTI- CONDUCTOR (Shown for comparison purposes only)	0.65	(17)	TV81 Mini	—	Vinyl	2,000	(610)	375	(273)
	1.1	(28)	TV81	—	Vinyl	3,000	(914)	875	(638)

HARRIS TRIAX SYSTEM SPECIFICATIONS

See the Harris TC-85 brochure for TC-85 camera specifications.

ELECTRICAL SCAN STANDARDS

EIA525/60.
CCIR625/50.

POWER REQUIREMENTS

Supplied by camera.

INPUTS AT CCU: Signals on 81 conductor cable connector and 14 pin triax accessory connector.

INPUTS AT HEAD: Signals on 81 conductor cable connector and 13 pin triax audio connector.

CHANNEL BANDWIDTH

GREEN VIDEO: 1 dB at 5 MHz.

RED VIDEO: 1 dB at 3 MHz.

BLUE VIDEO: 3 dB at 3 MHz.

VIEWFINDER VIDEO: 1 dB at 5 MHz.

OPERATING ENVIRONMENT

TEMPERATURE: Camera Head -20 to +50° C. Control Unit 0 to +50° C.

HUMIDITY: 0 to 95% RH, non-condensing.

ALTITUDE: 0 to 10,000 ft.

MECHANICAL

CAMERA HEAD: Height 12.5 in. (31.8 cm). Width 9.1 in. (23.1 cm) excluding camera cable. Depth 12.8 in. (32.5 cm). Weight 17 lbs. (7.7 kg).

CCU: Height 5 in. (12.7 cm). Width 19 in. (48.3 cm). Depth 21 in. (53.3 cm). Weight 40 lbs. (18.1 kg).

CABLE AND CONNECTOR ORDERING INFORMATION

Triax cable may be ordered in standard lengths of:

50 feet (15.2 m)
100 feet (30.5 m)
250 feet (76.2 m)
500 feet (152.4 m)
1,000 feet (304.8 m)

The above include connectors. Triax cable may also be ordered in 1,000-foot (304.8 m) rolls, without connectors.

Connectors available include:

Connector, male
Connector, female
Connector, female bulkhead
Connector retro-fit kits



HARRIS

TC-50B

Live Color
Television
Camera

- Best cost/performance ratio in the industry
- Excellent stability and reliability
- Outstanding capability under low-light-level conditions
- Quick, easy setup
- Rugged cast aluminum frame for precision alignment
- Accepts even the longest, heaviest lenses



TC-50B...Top-of-the-line broadcast

In the TC-50B, Harris has applied its extensive experience in broadcast equipment to offer you a camera with excellent color fidelity, superb picture quality, and great flexibility—all at a much lower price than you would expect for top grade broadcast performance.

The TC-50B is a prism camera using three 1-inch Plumbicon® tubes. The prism, which includes all color separation surfaces, is built and installed as a sealed package unit in the camera. This assures uniformity from camera to camera, and optimum colorimetry.

For operating convenience, a remote control philosophy has guided the design of the TC-50B. The camera is set up and operated from the Camera Control Unit, and controls at the camera head are minimized.

STABILITY AND RELIABILITY

Outstanding stability and reliability of operation have been achieved through rugged, imaginative design. For example, all optical components are mounted on a rigid cast-aluminum plate and case, and are completely adjustment-free, to assure long-term stability.

The cast-aluminum mounting plate and case comprise a solid, precision-machined, stress-relieved integral unit. Rigidity of construction permits the camera to accommodate all standard lenses, ranging from the basic 10/1 zoom, up through the longest, heaviest lenses with extended zoom ranges.

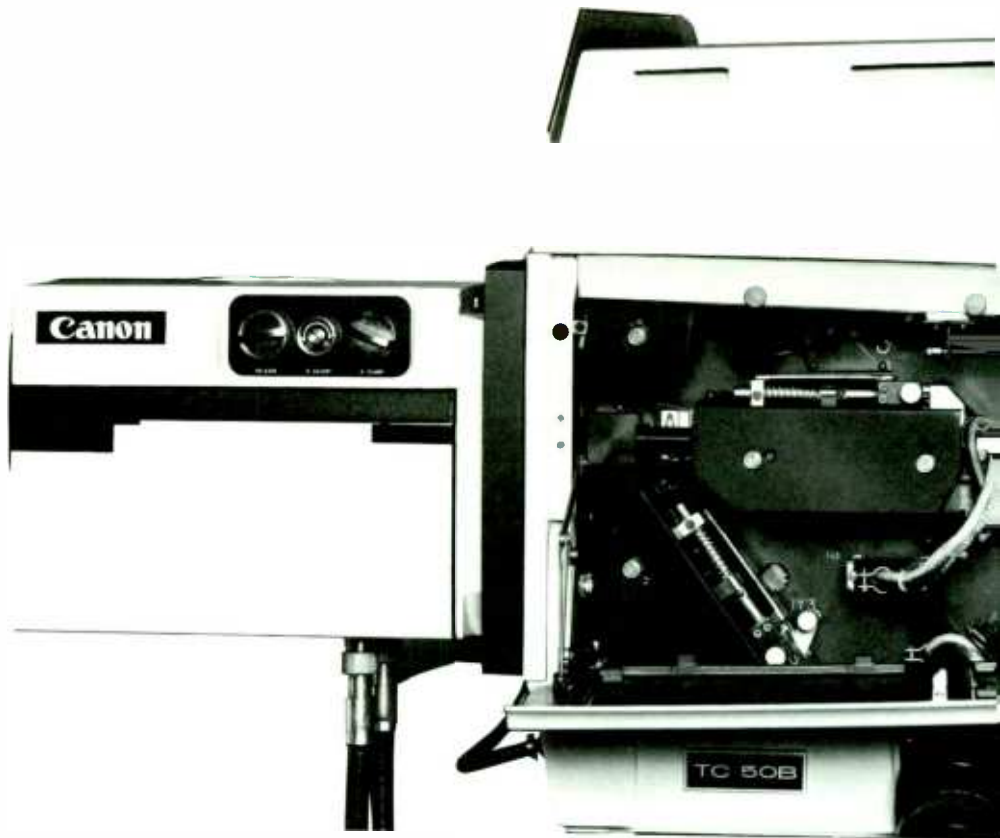

PRECISION YOKE ASSEMBLIES. Each of the Plumbicon® tubes is mounted in a computer-matched yoke. Each yoke assembly is precisely located on the rigid optical bed by a self-aligning quick release mechanism.

TRIPLE REGULATION. All critical voltages are regulated—not once but three times—to assure excellent stability of operation.

INTERFERENCE PROTECTION. Shielding is incorporated throughout the camera to minimize effects of radio frequency interference.

OTHER "BIG CAMERA" FEATURES

LINEAR COLOR MATRIX. Superb colorimetry is achieved through the use of a linear color matrix.

APERTURE CORRECTION. An integral horizontal and vertical aperture corrector produces sharp, clear pictures. For added crispness an integral contours-from-green image enhancer with comb filter is used.

LOW-LIGHT CAPABILITY. The TC-50B is designed for outstanding capability under low-light-level conditions. Through the use of a single master gain control, correct color balance is maintained with optimum signal to noise.

INTEGRAL BIAS LIGHT. The optical system includes an integral bias light which reduces lag when operating at low-light levels. This improves picture quality and avoids "smear".

ANTI-POLARIZATION. The TC-50B optical system incorporates a retardation plate, which eliminates color shift or distortion resulting from polarized light produced by sources such as polished floors or hair spray.

*Reg. trademark of N.V. Philips of Holland

quality at a middle-of-the-line price

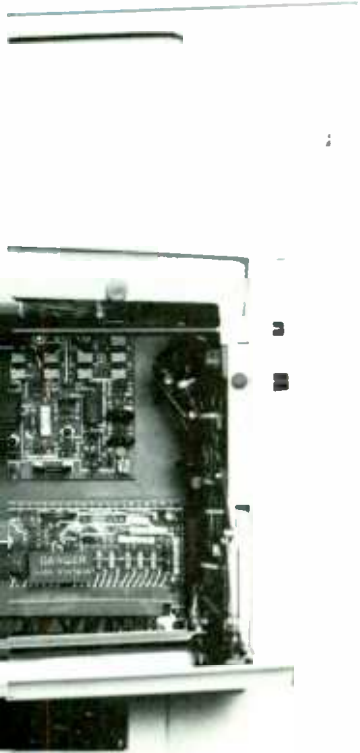

COLOR CORRECTION. A 5-position color correction filter wheel is incorporated in the optical system to allow for varying light conditions. To simplify use, the wheel is accessible without opening camera head doors. Optical filters are removable so that special effects filters may be used.

FLARE COMPENSATION. Controls are provided for flare compensation in all three color channels. This circuitry maintains blacks even under extremes of contrast.

INTEGRAL ENCODER. The camera system includes an NTSC encoder in the CCU control drawer. A built-in color bar generator facilitates encoder alignment.

CHROMA KEY OUTPUTS. Red, blue and green outputs are provided for use with Chroma Keyers or other special effects generators.

DESIGNED FOR CONVENIENT SETUP AND CONTROL

The TC-50B Camera Control Unit has three components: operate panel, set-up panel/control drawer, and power supply. These can be conveniently rack mounted in one location, or the operate

panel can be removed to another location.

MOUNTING. Control units can be mounted in a standard 19-inch rack occupying only 8 rack units (14 inches) or in a compact field case.

PICTURE ROTATION. A unique design feature provides an adjustment at the CCU for electronic rotation of the red and blue pictures. This eliminates the need for mechanical yoke rotation.

MASTER GAIN CONTROL. Under insufficient light conditions, the master gain control provides for boosting video gains while maintaining correct color balance. The master gain control is continuously variable, providing smooth transition and optimum signal-to-noise ratio.

PUSHBUTTON BEAM SET. The beam can be adjusted easily by using a pushbutton circuit which momentarily reduces sensitivity in each channel by 50%. This -6 dB gain feature facilitates following the recommended beam setting procedure.

MASTER BLANKING. The video operator can readily adjust the black level of the picture over a wide range with the master blanking control. The normal operating point is located readily by an electronic null at the center position of the control.



TC-50B operate panel and setup panel/control drawer.

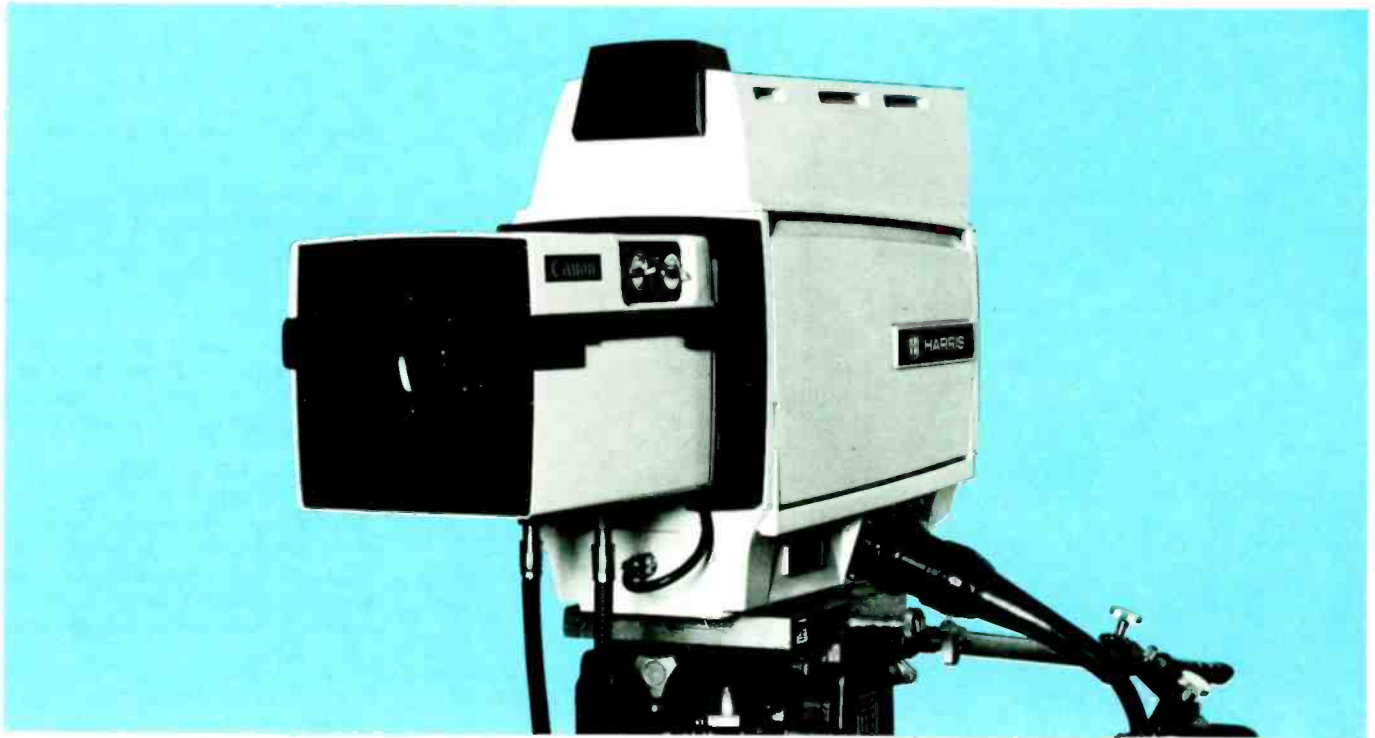

VIDEO METER. A small video meter on the front panel of the control drawer provides quick, simple setup of white balance and black balance and can substitute for a waveform monitor.

LENS CAP. The lens cap is remotely operable for ease of setup, and for standby periods.

CLIP CONTROL. To simplify setup, the camera is equipped with a master white clip control.

OPTIONS. Two plug-in module accessories are available for the TC-50B CCU: an integral cable compensator module for cable lengths up to 1500 feet; and an integral NTSC sync generator module.

CAMERAMAN CONVENIENCE

The TC-50B's operation is enhanced by its weight and size, which assure smooth panning and tilting. With controls centralized at the CCU, a technical man is not required at the camera head.

For the cameraman's convenience, the following controls are provided at the camera head:

- High peaking control, activated by pushbutton, to aid in focusing.
- Selectable viewfinder display.
- Viewfinder brightness and contrast.
- Intercom volume—one for each headset.
- Main tally "on-off" switch.
- Call button.

VERSATILE VIEWFINDER DISPLAY. The integral viewfinder is designed for versatility, with a three-position selection of display.

The encoded output position displays properly framed output of the camera. The CCU monitor switch output position presents individual red, blue, green or difference pictures. The external video position displays special effects such as split screen.

Separate viewing hoods for indoor and outdoor service are included.

TALLYS. The main camera head tally light is large, bright, and located on top of the unit for 360-degree visibility. Another tally is located on the viewfinder for convenience of the cameraman.

A two-way signaling system is provided between the camera and the CCU. A pushbutton at the camera head



Planned for Serviceability

energizes an audible signal and the tally light at the CCU. A pushbutton at the operate panel lights the camera tallys.

INTERCOM. An intercom system links the camera and the CCU. Facilities are provided at the camera head for two headsets.

A bridging input is provided so that program audio can be inserted in the intercom system. A volume control for this input is located at the CCU.

SCRIPT CLIP. As an added convenience feature for the cameraman, a script clip is provided at the rear of the camera.

The TC-50B has a rugged mechanical design, and numerous features to provide exceptional reliability. When service is required, however, the system is designed for ready accessibility and simplified service.

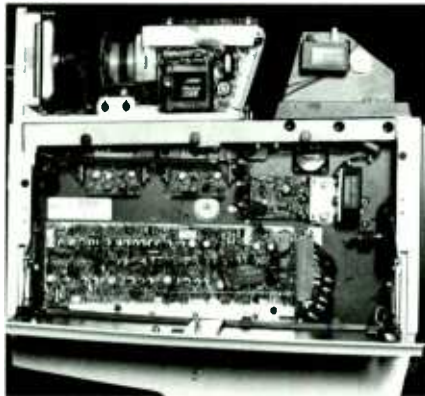

CAMERA HEAD. The camera head can be serviced without the use of extenders and circuit boards can be checked without being removed.



PICKUP TUBES. Tube replacement is quickly accomplished and does not require removal of other camera head components. Each computer-matched yoke assembly is attached with a self-aligning quick-release mechanism. A single connector provides connections for the pre-amp, the tube and the yoke.

INTERCHANGEABLE PRE-AMPS. Because of differences in sensitivity in the three channels, selectable pre-amp gain is provided to assure matched pre-amp outputs. Pre-amps are interchangeable, simplifying maintenance and stocking of parts.

REMOVABLE VIEWFINDER. The viewfinder is detachable. A long extension cable is provided to facilitate servicing.

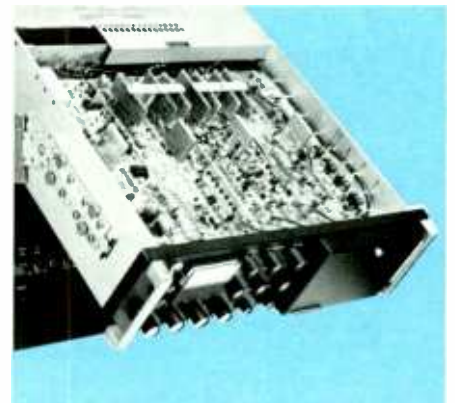

CCU CONTROL DRAWER. This drawer can be extended and tilted for easy access and servicing.

STATUS LIGHTS. Seven indicator lights inside the camera show availability of necessary voltages from the CCU to assist in fault isolation. Test points are provided at all critical locations to simplify maintenance.

HOUR METER. The camera head includes an elapsed time meter as a validation should a tube warranty claim arise.

USER CONNECTIONS. Tally light and intercom connections are readily accessible.

TC-50B SPECIFICATIONS

ELECTRICAL SCAN STANDARDS

EIA 525/60
 CCIR 625/50

POWER REQUIREMENTS

Voltage 90 to 130V or 180 to 260V,
 60 Hz (50 Hz on request)
 Power Load 260 VA (exclusive
 of monitoring)

INPUTS (Loop-Through, Bridging)

Sync2 to 8Vpp, negative
 H Drive2 to 8Vpp, negative
 V Drive2 to 8Vpp, negative
 Sub Carrier 1.5 to 4Vpp
 VF External Video 1.0Vpp composite

OUTPUTS

Program
 Video Two Composite,
 1Vpp across 75 ohm
 Chroma Key
 (R,B,G) non-composite 0.7Vpp
 across 75 ohm
 Monitor Video
 non-composite 0.7Vpp
 across 75 ohm

MONITOR SWITCHING FACILITIES

Picture and
 Waveform R,B, & G separately
 or combined with —G or
 —B; color output (program)
 Viewfinder output of picture &
 waveform monitor switch;
 Y video; external video

SENSITIVITY (Typical tubes)

Minimum incident light on 60%
 reflectance chip for full output
 with f2.0 lens 12fc
 with f1.6 lens 8fc
 Incident Light for
 rated Signal/Noise 100fc at f2.8
 Signal/Noise
 Ratio better than 50 dB
 (300 na green signal current;
 1.0 Gamma; bandwidth 10 kHz to
 4.2 MHz; masking, aperture and
 chroma—off)

Center Resolution: typically 40% @ 5MHz at
 program output—correctable to 100%

OPTICAL SYSTEM

Color Separation single unit prism
 with Integral Bias Light
 Correction Filters5 position
 filter wheel
 Depolarization retardation plate
 at prism input

PICK-UP TUBES

Red Amperex XQ1073 extended red
 Blue Amperex XQ1070B
 Green Amperex XQ1070G

REGISTRATION ACCURACY

Zone 1 (Circle=.8V) 0.05%
 Zone 2 (Circle=1.0V) 0.1%
 Zone 3 (Circle=1.0H) 0.2%
 Zone 4 (All Other) 0.4%

PICTURE GEOMETRY

Zone 2 0.5%
 Zone 4 1.0%

CAMERA CABLE LENGTH

Without Optional
 Module to 300 ft. (91m)
 With Optional
 Module to 1500 ft. (457m)

OPERATING ENVIRONMENT

Temperature
 Camera Head -20 to +50
 degrees C
 Control Unit 0 to +50
 degrees C
 Humidity 0 to 95% RH
 Altitude 0 to 10,000 ft. (3048m)

STABILITY

After a 30 minute warm-up the camera will
 perform within specifications for 8 hours,
 provided the temperature change does not
 exceed ± 10 degrees C or the specified
 limits.

SHADING PROVISIONS

H&V sawtooth and parabola modulation,
 H&V sawtooth and parabola additive, for
 Bias Light.

APERTURE CORRECTION

Combined horizontal and vertical aperture
 correction derived from green with comb
 filtering and noise coring.

GAMMA CORRECTION

Continuously variable from linear to 0.35,
 each channel.

INTERCOM

Party Line600 ohm balanced
 to ground
 Camera Head accommodates
 two headsets;
 separate amps & controls
 Operate Panel one headset,
 amp & controls
 Program Audio bridging input
 (unbalanced with level control)

SIGNALING SYSTEM

CCU to Camera pushbutton
 operates camera tally lights

Camera to CCU pushbutton
 operates tally lights
 and audible signal

VIEWFINDER

Screen Diagonal 6.1 in. (155 mm)
 Picture Brightness 0 to 150 ft.
 lamberts
 Resolution better than 600 TV lines
 Picture Timing AFC
 Video Equalization Automatic to
 maximum cable length
 Controls Contrast, Brightness,
 Video Peaking and
 Input Select

MECHANICAL

Camera Head (Less lens)
 Height 19.5 in. (495 mm)
 Width 10.5 in. (267 mm)
 Depth 21 in. (533 mm)
 Weight Approximately
 75 lbs. (34 kg)

Control Drawer

Height 5.25 in. (133 mm)
 Width 19 in. (483 mm)
 Depth 22 in. (559 mm)
 Weight 20 lbs. (9 kg)

Operate Panel

Height 1.75 in. (45 mm)
 Width 19 in. (483 mm)
 Depth 7.25 in. (184 mm)
 Weight 2 lbs. (.9 kg)

Main Power Supply

Height 7 in. (178 mm)
 Width 19 in. (483 mm)
 Depth 18 in. (457 mm)
 Weight 38 lbs. (17 kg)

ACCESSORIES

NTSC Sync Generator Module
 Cable Compensation Module
 All one-inch format lenses from Angenieux,
 Canon, Fujinon and Schneider
 Camera Cable, std. lengths 50 ft., 100 ft., 150
 ft., 200 ft., 250 ft., 300 ft., 400 ft., 500 ft.
 Operate Panel Extension Cable, std. lengths
 25 ft., 50 ft., 100 ft., 200 ft.
 Headset, single and dual
 Conrac SNA9, 9-inch Picture Monitor
 Tektronix 528 Waveform Monitor
 ITE Cam Head, H2 or H3; ITE P4 or P5
 Studio Pedestal
 ITE-WA Wedge Adapter; ITE-WP Wedge
 Plate
 Quick-Set (Houston-Fearless) and Vinten
 Cam Heads, Pedestals, etc.
 Vinyl Rain Cover



HARRIS

TC-90

**The first 3-tube
ENG/EFP camera
to weigh in
under 7 pounds!**

Critical pounds lighter to make your job easier in the field. The new Harris TC-90 features a proven space-age graphite filament case and other design advances to give you the lightest, smallest, yet most rugged three-tube camera available today!

There are no compromises in video quality. One-half-inch Plumbicons* or Saticons** equal the signal-to-noise performance of 2/3-inch tubes, yet draw less power for longer battery life. And you get three-tube resolution and sensitivity.

There's more:

- Low profile design for an unobstructed view over the camera.
- Extensive use of LSI chips for unmatched stability.
- On-board 2 AH battery pack for up to 1.3 hours of operation.
- Optional EFP control up to 1,000 feet through RG/59 cable. No interface unit required.
- U. S. designed and manufactured.
- Backed by Harris' 24-hour-a-day service.

* T.M. N.V. Philips of Holland
** T.M. Hitachi





Nothing has been left out of the TC-90's connector panel for complete system integration.

TC-90 SPECIFICATIONS

ELECTRICAL SCAN STANDARDS

EIA525/60
 CCIR625/50

COLOR STANDARDS

NTSC
 PAL-B
 PAL-M

SYNC

RS170A

GENLOCK

Composite color signal or color black.

TUBES

80XQ Plumbicon or BC-4398 Saticon, 1/2-inch.

OPTICAL SYSTEM

f1.4 prism with filter wheel and bias light.

LENS

Industry standard bayonet mount for 1/2-inch format.

RESOLUTION

600 TVL/pix height
 limiting at center

SIGNAL-TO-NOISE RATIO

Better than -57 dB.

SENSITIVITY

Usable pictures under 5 fc with +18 dB gain added.

AUTOMATIC FEATURES

Auto white
 Auto black
 Auto iris

POWER INPUT

10.7 to 15 volts DC. On-board 2 AH battery pack or battery belt.

AMBIENT TEMPERATURE

-20° C to +50° C.

MAXIMUM ALTITUDE

10,000 feet ASL (3048 meters).

WEIGHT

Under 7 pounds (3.18 kg.)

EXTERNAL CONTROLS

VTR Start
 Bars, Beams Off, Camera
 +18, 0, +9 dB Gain
 White/Black Balance
 Viewfinder Selectors: RGB, Y, Ext;
 R, Off, B; G, Off, -G
 Intercom Volume
 On, Standby, Off
 Power (from) Battery/VTR

CONNECTORS

Video Out
 Ext Monitor Video Out
 Remote Control In
 Genlock In
 Spare
 Headset
 Intercom Line Out
 Program Mic In
 Fuse
 14-Pin VTR Connector

Specifications subject to change without notice.

EPIC...the Editor's Editor

The Harris EPIC is designed for just one thing: To carry out editing decisions instantaneously. On line or off. Without a lot of back talk. This approach is what accounts for EPIC's rapidly growing acceptance by broadcasters and production houses across the country. EPIC is truly an Editor's Editor.

Unequaled Editing Convenience

Completely Developed Software: No need for computer experience or programming knowledge. Commands and displays are in everyday English, and operator training is minimal. Software also makes updating to more powerful routines easy.

Master/Slave Operation: Allows synchronization of up to 8 VTRs or ATRs under system control.

Sync Roll and Mark: Create an edit decision list from several sources, or "edit on the fly," for a tremendous savings in editing time. All creative production switching can now be done in post production.

Auto Assembly With Look Ahead: Allows you to see future events while your system is rolling. No more "stop and look" procedures that interrupt the process and add to production costs.

Time Saving Multi-Tasking: You are able to do more than one thing at a time. For example, simultaneously perform an edit on one VTR, write time code on another, and print an edit list on the optional printer. This feature alone can save many hours over other editing systems.

Direct Action Keyboard: Single key access to most functions means that you can accomplish the same job in less time compared to doing it keystroke-by-keystroke.

Direct Function Access: The elimination of computer dialogue saves time, simplifies operation.

Custom Versatility: Many functions can be tailored to your special requirements. Initialization, for example, is an easily changed software routine.

Rapid Entry of Edit Data: Enter edits from floppy disk, paper tape (optional), on line video tapes or manually.

You can also modify them any way you want — without addition or subtraction.

Flexible List Management: Modify decisions, insert new ones anywhere on the list and move or delete existing ones. Changes are verified immediately on the display. Pushbutton selection of ripple or non-ripple is also standard.

Unequaled Editing Power

A 32K-Word Memory Central Processor: Combines with floppy disks to provide unequalled editing power.

Grass Valley "E-MEM" Interface: Provides direct control of two mix-effect busses (allows register calls on both busses) for more versatile and spectacular effects than ever before.

Readily Available Interfaces: EPIC is now interfaced to virtually every model of audio and video recorder, and operates with most video switchers. Split audio/video edits, with no limit on in and out times, is also standard with EPIC. You have complete control of all VTR functions such as shuttle speeds, slow motion and so on. Whatever the VTR will do, EPIC will do.

User Bit Reel Identification: Reel numbers are put on tapes in user bits. EPIC reads the tape, and the reel number appears on the display.

Multiple Display Format: EPIC provides several different, uncluttered displays. And, since the display is a standard TV monitor, updates and changes are displayed almost instantly.



Video Production Services, Berkeley, California uses EPIC to give their customers both editing speed and flexibility.



Excalibur Video Systems, Los Angeles, California finds EPIC a perfect complement to their state-of-the-art production and post-production facility.

more versatile than ever

Plus Proven Standard Features

Multi-Tape SMPTE or EBU Time Code Generation and Reading: Permits coding of 4 tapes simultaneously, saving hours of production time. A time code reader is included on each VTR interface card. You don't need expensive, stand alone time code generators or readers for each VTR.

Jam Time Code: Allows rewriting missing or poorly recorded time code.

Adjustable Cue Time: Variable from 3 seconds to 2 minutes to match pre-roll times to varying VTR requirements or different tape conditions.

Color Framing: EPIC relates the record VTR to house color framing, thus eliminating the possibility of improperly framed color edits.

Preview Single or Multiple Edits: On the master, on the source or on both together.

Mix Drop and Non-Drop Frame Tapes: An added convenience for production applications.

Text Notations: Notes are recorded with edits and will appear on the display when the edit is recalled.

Choice of Outputs: In addition to floppy disk list output, the EPIC system can be supplied with a printer, and an industry standard compatible paper tape punch/reader.

Reliability Backed By Service: Since EPIC has less electronic hardware than most other systems, there are fewer things that can go wrong. And that means less downtime. In addition, every EPIC is checked out completely before shipping, using the most stringent standards in the industry. Along with this, an established worldwide network of Authorized Sales and Service Distributors provides unequalled service support.

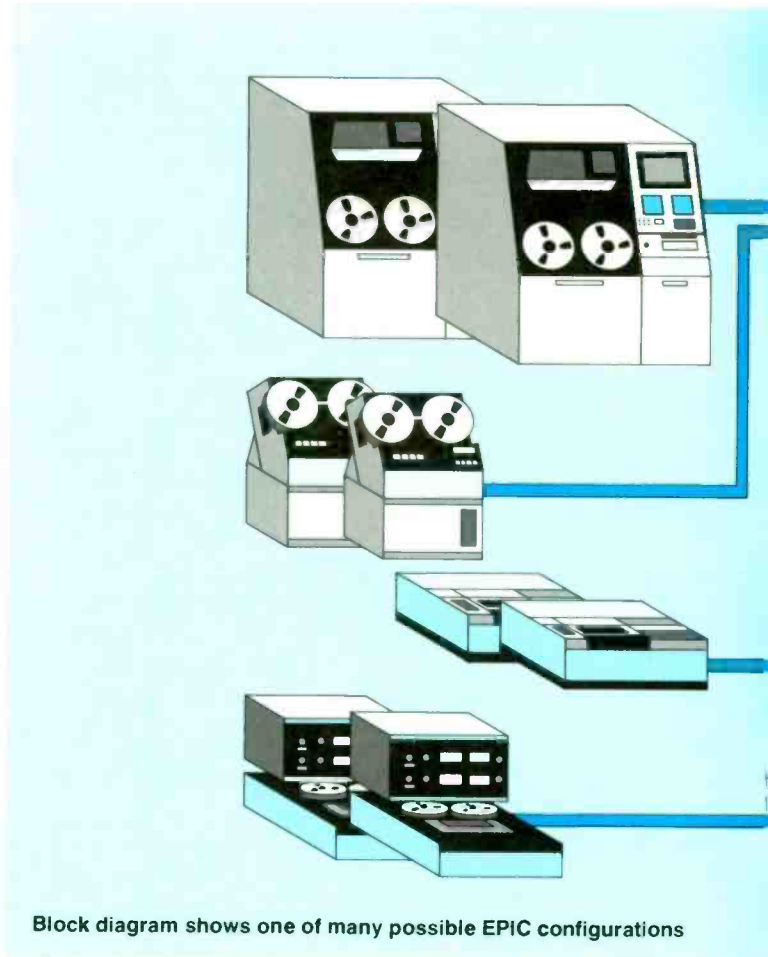

Block diagram shows one of many possible EPIC configurations



T.V. Associates, Mountain View, California is using EPIC to meet the high level needs of the industrial video market.



Helix 1 Productions, Hollywood, California takes advantage of EPIC's software versatility to produce quality video.

and more powerful.

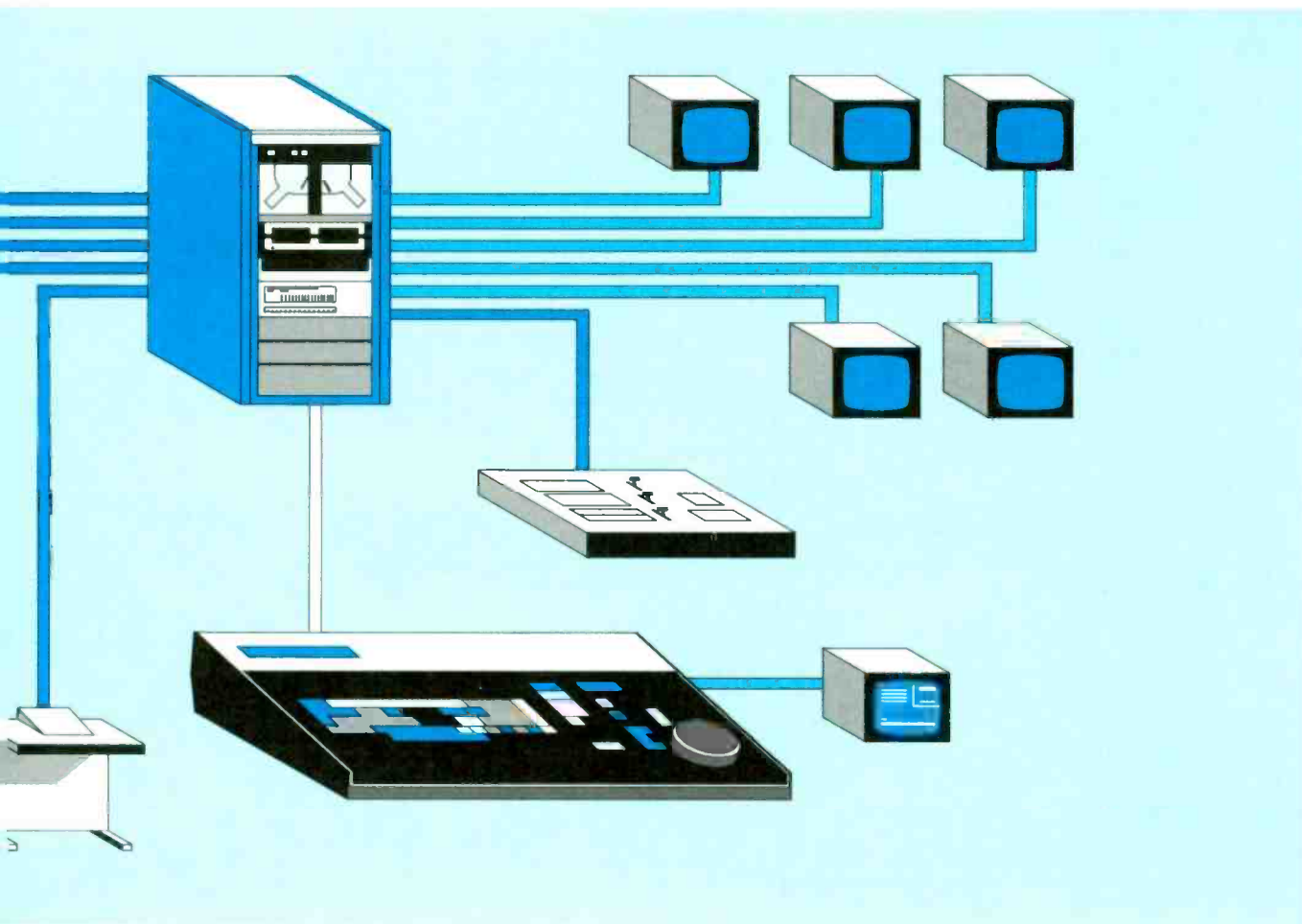

Western Video, San Diego, California uses EPIC to provide high quality editing with short turn-around times.

EPIC Fits Your Facility

EPIC provides everything you need for professional, multiple VTR editing. The basic 3-VTR system can be easily expanded to 8 VTRs/ATRs by merely adding plug-in interface cards. In addition to a complete software package, the standard EPIC system consists of a keyboard, a proven, off-the-shelf minicomputer, a disk storage unit and a digital control unit.

All EPIC components, except the keyboard, fit in a customer-supplied 19" rack. And, since the keyboard is compact, you can put it anywhere you like: on a desk or in your own custom console. You can also put the display anywhere you want because EPIC uses a standard video monitor to display the edit list.

EPIC EDITING SYSTEM SPECIFICATIONS

Central Processing Unit

Data General Nova 3/4 Minicomputer with
32K Word Memory

Dimensions 5.25" (13.3 cm) high
19.0" (48.3 cm) wide
23.0" (58.4 cm) deep

Digital Chassis

Dimensions 10.5" (26.7 cm) high
19.0" (48.3 cm) wide
20.0" (50.8 cm) deep

Keyboard

Dimensions 4.0" (10.2 cm) high
25.75" (67.3 cm) wide
11.5" (29.2 cm) deep

Floppy Disk Chassis

Dimensions 5.25" (13.3 cm) high
19.0" (48.3 cm) wide
20.0" (50.8 cm) deep

Single drive standard, dual drive optional

Audio/Video Chassis (optional)

Dimensions 10.5" (26.7 cm) high
19.0" (48.3 cm) wide
20.0" (50.8 cm) deep

Printer (optional)

Centronics 702 or 703

Dimensions (without stand) . . .8.0" (20.3 cm) high
24.5" (62.2 cm) wide
18.0" (45.7 cm) deep

Paper Tape Punch/Reader (optional)

Remex RAF-6075BB

Dimensions 10.5" (26.7 cm) high
19.0" (48.3 cm) wide
14.5" (36.2 cm) deep

Control Cables and Keyboard Cable

Flat Ribbon Type

Length 30' standard (optional to 500')

Power Requirements

EPIC System (with
audio/video chassis) 115/120 VAC 50/60 hz
@ 7.5 amps

Signal Requirements

Inputs

Reference Video 1.0 V nom., 75Ω (loop thru)
All Other Video Inputs 1.0 V ±3 dB, 75Ω
All Audio Inputs 600Ω balanced,
unbalanced (opt.)

Outputs

Video Outputs 1.0 V, 75Ω
All Audio Outputs 600Ω unbalanced, unity gain
Video Output,
Display Monitor compatible with 525/60
TV monitor

The Company Behind EPIC

EPIC is just one of the ways Harris Video Systems (formerly Consolidated Video Systems) uses modern digital and analog technology to make your video production look better. Besides being the acknowledged world leader in digital time base correction, Harris also manufactures other advanced products using video and digital techniques for professional television.

Worldwide customers include all major TV networks, many independent commercial and educational stations, most large duplicating facilities and a large number of educational, industrial and CATV organizations. All Harris products are backed by a worldwide network of Authorized Sales and Service Distributors. For a demonstration of the HVS, EPIC Editing System, or any other Harris product, contact your local Authorized Distributor.

IRIS: Fingertip Access to 5,928 Stills

Today, the advantages of digital still stores over conventional broadcast slide libraries are widely accepted. And now, the IRIS system from Harris makes digital still storage an even more powerful and cost-effective production tool.

The IRIS Digital Still Store System provides on-line, random access — by up to three separate, simultaneous users — to a maximum of 5,928 separate, individually cataloged, broadcast quality video still images. A Z-80 based microprocessor gives you total operational control of each still.

Even if you already have a large number of optically prepared slides, you will find the IRIS advantageous because it provides savings in production time, increased production versatility and significant cost savings. Additionally, since you can store "on the fly" from moving video images, you have an even wider range of material from which to create your library.

Variety of Inputs

The IRIS accepts inputs from VTRs (including stable or unstable heterodyne signals), live cameras, network feeds, character generators, and telecine. Even frames that have rapid motion pose no problem for IRIS. A single keystroke on the IRIS keyboard gives you a "repeat field" display that eliminates inter-field flicker.

Large Capacity, Modular Storage

IRIS gives you fingertip access, via a free standing keyboard, to as many as 5,928 stills at one time. Stills are recorded on modular, removable disk packs which are used with standard disk drives.

Packs are available with differing capacities so that you can tailor an IRIS system to your current needs while having the ability to expand later. Since the disk packs are removable, off-line still storage is limited only by the physical space available.



Cost Effective

In terms of cost-effectiveness, IRIS offers several economic advantages over systems using optical slides. For example, you eliminate slide handling and maintenance costs and prevent losses caused by slide damage. Most importantly, however, you gain a versatility and convenience that makes your production go faster and smoother, and the ability to create your own stills on the spot. That's where the real economic payoff of IRIS shows up.

Simultaneous, Multi-User Access

The IRIS system features four I/O ports that will accommodate up to three independent users and a computer control channel. And, with additional keyboards and memory channels all three users can have almost simultaneous access to every still. In this kind of operation, even if two users seek access to the same slide at the very same time, there is only a one-half second delay.

For installations where the convenience of keyboards in several locations — but not simultaneous access — is needed, you can just add keyboards to the IRIS system.

Preview

This function is provided by a single key (PVW) on the IRIS keyboard. It allows you to preview one still while, at the same time, the preceding still is "on-air."

Station Automation Interface

The availability of a standard RS-232 input/output port on the IRIS allows access and control by a station automation system through an appropriate interface. For example, a station computer could call up an already prepared list by title.

This feature also opens up the possibility of other automation tie-ins. Interface with an editor, to store key scenes for a promo or to call up a still for insertion into an edit sequence, are just two examples.



Basic System

The IRIS system is totally flexible and is designed to accommodate a wide variety of users. The basic system described here can be expanded to handle almost any still store requirement.

Keyboard: A free-standing keyboard with single, dedicated keys for almost all IRIS functions makes operation of the IRIS system easy to do and very easy to learn. For almost all functions, one key-stroke performs one action. If you wanted slide AB143, for example, you just key in "AB143" and push the "PVW" (Preview) key. Slide AB143 appears in a fraction of a second.

A limited keyboard is also available for installations where a user may not need full operational control of the entire still library.

Control System: A Z-80 microcomputer handles all operational commands and provides a display output to customer-supplied video monitors.

Disk Controller: Handles up to eight disk drives which accept disk packs of varying capacities to meet specific system requirements.

Input/Output: Video input and output is via an HVS 630 Framestore Synchronizer. The IRIS system can accept up to two additional 630s and three additional 630 "read only" units. The latter units provide full access to preview and management functions, but cannot be used for creation of new stills.

IRIS: Total Still Library Management

Total Management & Control of Stills

A major feature of IRIS is comprehensive and flexible list and file management and control capabilities. You can store a still with a system-generated ID alphanumeric as well as a description. As a result, you can search the stills by either ID number or description. You can also use the IRIS to record and store the date a specific still was entered into the system.

Browsing: This is the ability to play back a group of stills with similar pack numbers and IDs, or with similar descriptions.

A "wild card" (random access) technique is used in specifying the pack number, ID and description for browsing. An asterisk is used in the code to indicate "all." For example, "200:*" means "play all slides on pack 200"; and 200:AA* means "play all slides whose first two characters of the ID are AA and are on pack 200." Or, for example, if you wanted to review all stills under PRESIDENT, you'd just enter ";PRESIDENT" via the keyboard and hit the BROWSE key. A sequence list can be played and edited concurrently with a browse. This allows you to insert stills into your sequence list.

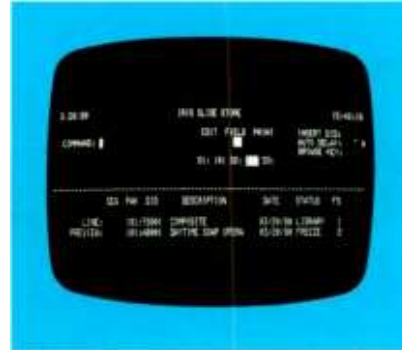

Copying: IRIS gives you the ability to copy stills, and entire lists in one pack and store them in another. For example, you might want to put a copy of a still in disk pack 1, on disk pack 2 because it fits in an additional category. Or, you might want to store it off-line. So, you copy it on a library pack and put it away.

When a still is copied for storage elsewhere, a new ID or complete title can be assigned via the keyboard. This feature allows you to set up ahead of time if you know that a still or group of stills is going to be needed by different users at the same time. Since your stills are always in digital form, they can be copied on another disk with no loss of quality.

Sequence Lists: Generation of sequence lists is fast and easy with IRIS because of the use of single function keys on the keyboard. Creating or editing a sequence list is done by a series of inserts and deletes. Scroll keys are used to position the cursor to the appropriate line in the list prior to insertion or deletion. Once a list is generated, it can be stored with a title of up to 8 alpha or numeric characters. A key labeled "SAVE LIST" is pushed to record the lists.

In operation, when "SEQUENCE" is selected on the keyboard, the first five lines of a list are displayed; a second command provides scrolling and display of the entire list. Lists can be played forward or backward using a single key on the keyboard. Provision is also made for playing back two or more lists as if they were a single list. Slides called in a sequence list do not have to reside on the pack containing the list.

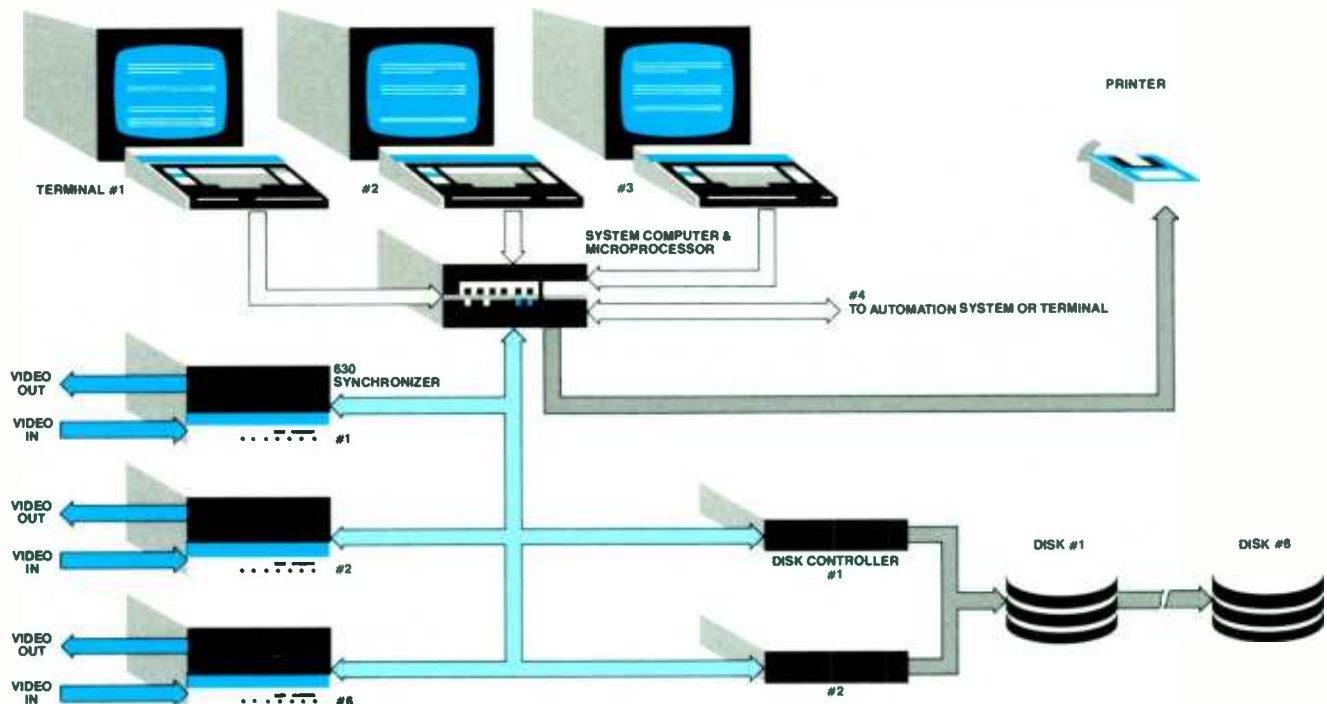

Typical IRIS system configured for three simultaneous users.

Automatic Sequencing: An Auto Display mode allows IRIS users to automatically sequence through an existing list of stills at a rate determined by a simple keyboard entry. For example, pushing "2" and then the "AUTO" key puts up a new slide every two seconds.

Maximum throughput rate is approximately one slide every 4/10 of a second. With this feature, you can quickly and economically put together program recaps and promotional spots.

Pre-Titling: Adding a title to a still for later use is another convenience feature of IRIS. You can call up a still, title it, and then store it for later use, under either the same ID or a different ID. When you do call it up, you won't have to tie up your character generator at that critical production point. And, whether you're putting together a commercial or the evening news, the more you can do ahead of time, the smoother your production will be.

System Operation

The video signal interface for the IRIS system is the HVS 630 Digital Framestore Synchronizer. It accepts synchronous or asynchronous input signals and stores them as a frame of video data. This data is encoded, converted to digital format and read out, in parallel, to the disk controller. Under computer control, the controller formats the data for serial recording on the disk.

To access stills, the disk controller, again under computer control, interrogates the disk drive, reads the serial data stream, encodes it into 8 bit parallel and sends it to the 630. The 630 stores it in a buffer memory and converts it back to analog for video display.

NOTE: Although the basic IRIS comes with one keyboard, and one HVS 630, the system can handle up to five more units — any combination of full synchronizers and read-only synchronizers. The read-only units provide access to all features of the IRIS except creation of new stills from external sources.

IRIS: Proven, Modular Hardware

Video Input/Output

The video input/output device used in the IRIS is the HVS 630 Framestore Synchronizer, which can be used separately when not needed for IRIS operation. If you already have a 630, IRIS capabilities can be easily added.

This versatile unit comes with both field and frame freeze, and a built-in time base corrector that exceeds the performance of stand alone TBCs. The unit also has RGB in *and* out.

In the 630, the video signal is processed in component — instead of composite — form. This makes the 630 immune to H-picture shift, cycle jump and color phasing. Edits and hot switches are handled smoothly. This approach also allows separate manipulation of chroma and luma to take maximum advantage of picture improvement technology.

In addition, the 630 brings you several specific benefits for IRIS operation. First of all, it frees you from worrying about system timing. Asynchronous inputs from any location can be used, and locked to station reference. And, the 630 can accept both stable direct and unstable heterodyne video signals.

Furthermore, the 630 can have, as options, a plug-in Digital Noise Reducer and a plug-in Compressor/Positioner. So, you can clean up noisy sources at minimal added cost, and add effects to your stills before displaying them.

Standard, Modular Disk Systems

The IRIS storage system is built around a family of proven drives and disk packs that allow you to tailor an IRIS system to your present needs without limiting you in the future. Disk drives are unmodified, commercially available models with excellent MTBF characteristics. Several sizes meet differing library and studio operation requirements.



Hard Copy Printer

A hard copy printer is available as an IRIS option. It can provide a directory of the entire store, copies of already prepared lists, or a list of all the stills on a particular subject. Among other things, this allows off-line selection of slides for program preparation.

Tested Reliability

Recognizing the critical need for reliable operation in the management of a still library, HVS engineers have made maximum use of proven computer hardware and operational designs. This is reflected in the use of an advanced Z-80 microcomputer control system, and the use of "off the shelf," major brand disk drives. In addition, all components of the IRIS system are thoroughly tested before shipment.

Designed for the Digital Future

Besides providing unequalled capability for the creation, storage and use of still images, IRIS opens the door for even more sophisticated applications. Since IRIS is structured as a computing system, access to all the data in a video image is readily available. As a result, it may become possible to perform a variety of special effects through the use of software programs.

Generation of slides without a real image is another possibility. This "future" is important because, at the rate digital video technology is moving, new techniques will be developed, and present techniques will be enhanced. If your stills are in digital form, you will be able to take advantage of these developments.



IRIS SPECIFICATIONS

Library

- Pre-programmable stills 5,928 (max.)
- One-line still storage 5,928 (max.)
- Number of users one in basic system, three maximum plus one RS-232 computer interface.
- Number of disk drives two in basic system, eight maximum.
- Number of slides/drive 97, 195, 369, or 741.

Video

- Inputs (1) 1V p-p composite, stable direct, or unstable heterodyne. (2) Reference (gen lock) 1V p-p composite video or composite sync and subcarrier. High impedance looping.
- Signal-to-Noise 57dB one (p-p signal to RMS noise) as measured on a Rohde and Schwarz noise meter.
- Differential phase 1.5°
- Differential Gain 1.5%
- 2T K Factor 1%
- C/L Delay 17ns max.
- Optional Digital Noise Reducer and Compressor/Positioner.

Physical & Electrical

Unit	Power	Size	Weight
Disk drive(s)	1200 watts	36" h x 36" w x 23" d	550 lb.
System controller	200 watts	10.5" h x 19" w x 22" d	35 lb.
Disk controller	200 watts	3" h x 19" w x 22" d	35 lb.
630 Syn-chronizer	350 watts	10.5" h x 19" w x 22" d	50 lb.
Keyboard	50 watts	4" h x 19" w x 10" d	10 lb.

Specifications subject to change without notice.





CVS 516WB Digital Time Base Corrector

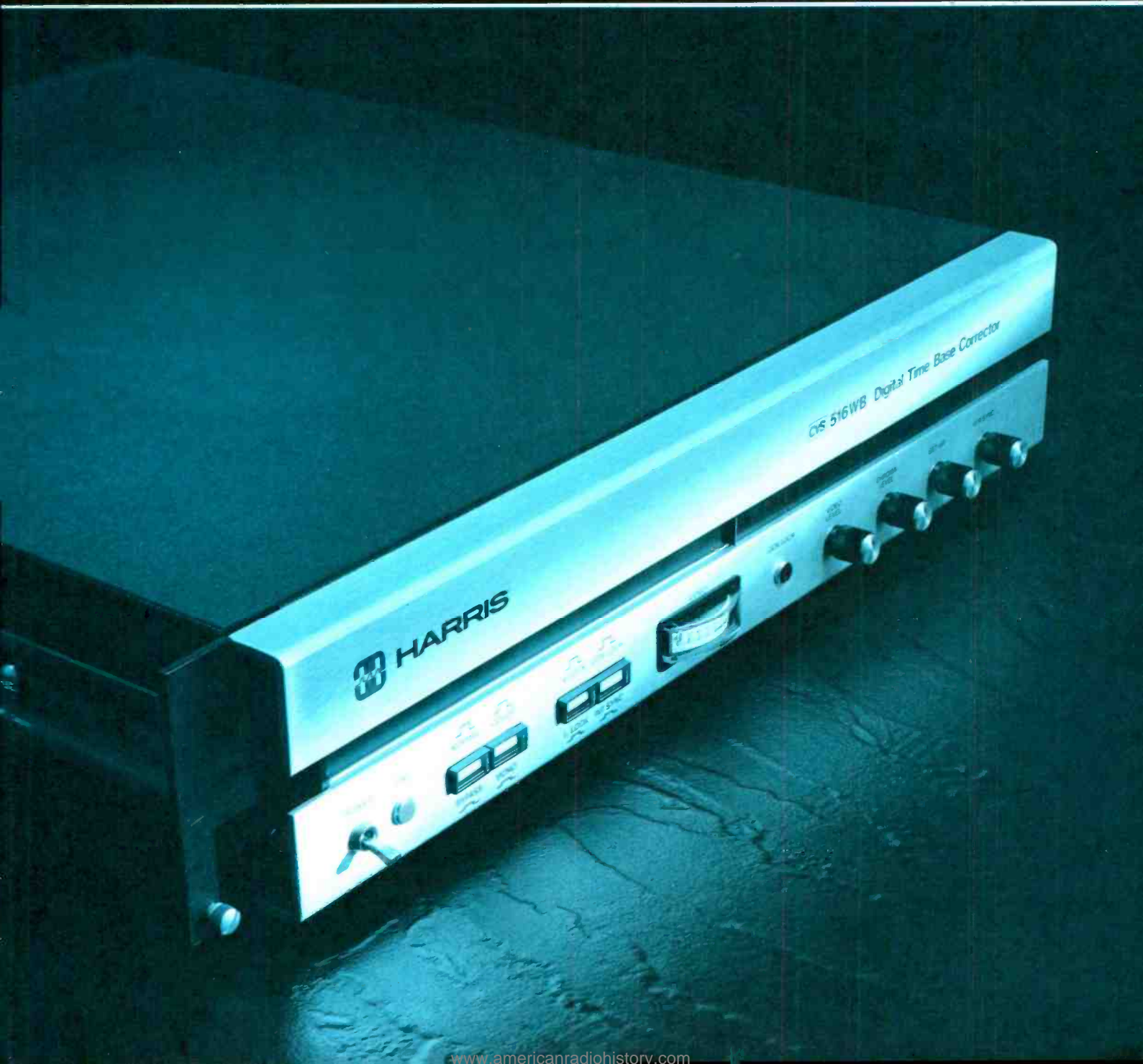

CVS 516WB: the ideal TBC for heterodyne VTRs

The CVS 516WB by Harris Corporation is a broadcast quality, NTSC digital time base corrector. This wideband TBC gives the user of any non-segmented, heterodyne VTR all the proven advantages of modern digital video processing, plus the bandwidth to handle the extended frequency response of the new generation VTRs.

ENG/EFP, CATV, Production and Post-production applications benefit from the 516WB's component-coded processing techniques and $4 \times F_{sc}$ sampling in terms of excellent time base error handling characteristics and reduced video noise levels. The 516WB, based on CVS's experience with over 3,000 digital TBCs, is our most advanced and reliable 516 yet.

OPERATION

The CVS 516WB accepts an input video signal, separates it into component form, digitizes and stores it. The signal is then encoded, clocked out at a corrected rate and referenced to either an external or an internal sync generator. The result is a time base corrected video signal.

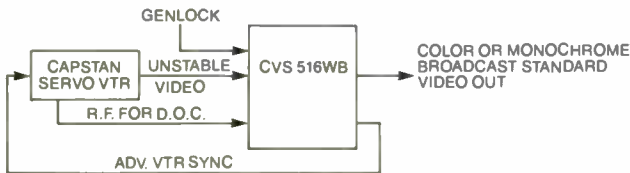

Capstan servo VTR operation.

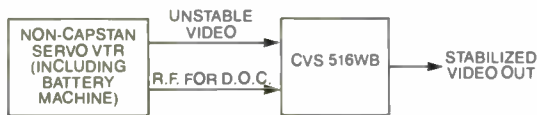

Non-capstan servo or "line-lock" VTR operation.

When the input signal to the CVS 516WB is a heterodyne type recording from a capstan servo VTR, the output signal is a broadcast stable, fully interlaced and color framed video signal. If the input signal to the CVS 516WB is a heterodyne type recording from a non-capstan-servo VTR, the output signal is a stabilized color signal. When the input signal to the CVS 516WB is a wideband, 525/60 monochrome signal, the output is a stabilized signal with a bandwidth of 4.2 MHz.

APPLICATIONS

The CVS 516WB, with its advanced features and ease of operation, opens up entire new application areas for the use of video. The following are just a few of the uses for this versatile TBC.

ENG & EFP

The 516WB plays an integral and unique role in field production. You can use a portable VTR for remote coverage and then beam the recorded signal back to the studio without the old TBC limitation of reduced bandwidth. And, 3.58 feedback, impossible in this situation, is not required.



Back-Up Operations at the Studio

Instead of using an expensive "C" format or quad VTR for back-up recording requirements, use the CVS 516WB with an inexpensive, V lock heterodyne VTR. This allows you to make better and more efficient use of your expensive machines to do in-house production. Overall savings can be significant.



Dubbing, Editing & Problem Tape Correction for CATV, Production and Post-Production

The CVS 516WB effectively handles many chores related to production, cable and closed circuit TV operations, whether monochrome or heterodyne color. Among other things, it ensures high quality picture playback for special review, training, or CCTV distribution systems. It also gives you the ability to do quality editing and dubbing. Multi-generation dubs are crisper than ever before with the 516WB's extended bandwidth.

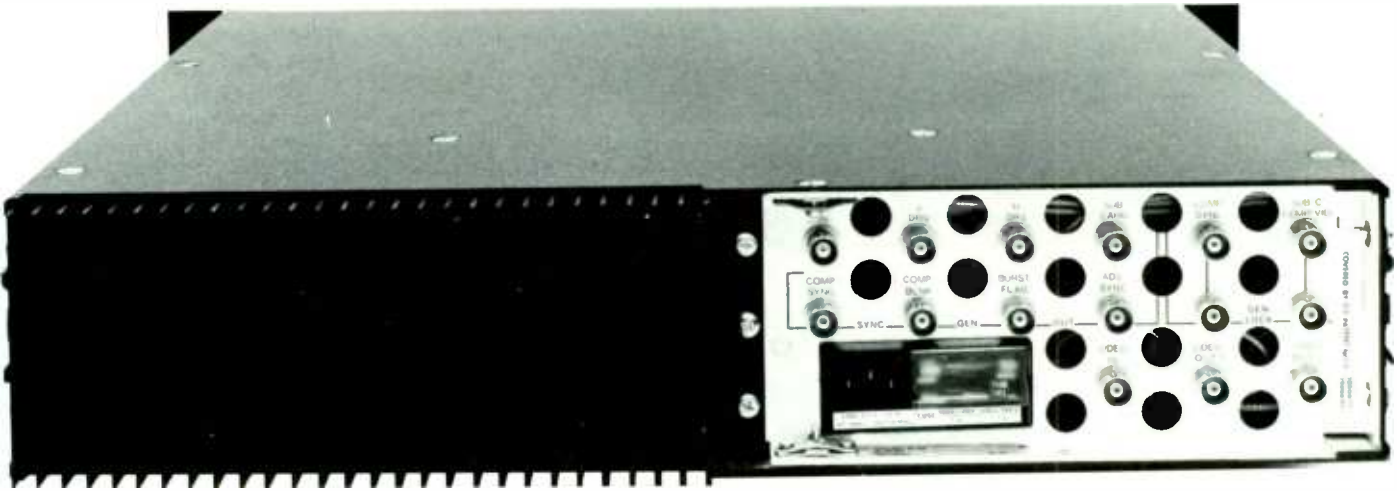

FEATURES

- **16 Line Window:** handles large time base errors and allows playback of many formerly unuseable tapes.
- **"Gyrocomp" Memory Organization:** allows correction of gyroscopic errors without breakup or hue shift, to make ENG tapes broadcast compatible.
- **Bypass-to-VTR Record Mode:** automatically routes the composite video genlock signal to the TBC advanced sync output. This allows the VTR to record the composite genlock signal without cable change or routing switcher.
- **Automatic Advanced VTR Sync:** automatically monitors off-tape and local sync to correctly position vertical blanking.
- **Digital Color Averaging:** lowers chroma noise by 3 dB and reduces velocity errors by using digital variable delay lines to average chroma.
- **Compact Size:** advanced electronic circuitry makes the CV5 516WB exceptionally compact, a key advantage for field production. Height is just 3½ inches (8.9 cm); weight is only 35 lbs. (15.9 Kg).
- **Convenient, Front Panel Operation:** controls have a pre-set unity position to reduce the possibility of misalignment. Secondary controls and switches are behind a sliding cover — easy to get at, but protected from accidental use.
- **One Cable Genlock Sync Generator:** simplifies system interface.
- **Built-in, Full Control Processing Amplifier:** gives operator complete control over signal processing.
- **Digital Chrominance-to-Luminance Delay Adjustment:** compensates for a common heterodyne VTR defect.
- **Frame Locked Vertical Interval Edits:** automatically color frames random edits.
- **VTR Versatility:** works with heterodyne capstan servo and non-capstan servo VTRs and allows dub-up to direct VTRs.
- **Full Set of Sync Generator Outputs:** provides a back-up to your facility's master sync generator.

OPTIONS

H & V Variable Blanking

This valuable option allows the operator to maintain input H & V blanking widths throughout TBC processing.

Fiberglass Carrying Case

Unique packaging and minimal weight (35 lbs.) make the CV5 516WB easy to take anywhere. A custom designed fiberglass carrying case provides full protection for the unit — a special advantage when doing field productions.

Reliability

The unique "flat-pack" design of the CV5 516WB makes all components easily accessible for fast maintenance, testing and troubleshooting without extender boards.



Each CV5 516WB is individually tested before shipment using the toughest quality control in the industry. This includes individual testing of each board. Units are then vibration tested, baked, and checked by inspectors who are independent of manufacturing. The result? A TBC that stands up to the most demanding operation, backed by a worldwide network of distributors and service centers.

CVS 516WB SPECIFICATIONS

GENERAL

Signal Processing	Component coded, digital design with 4 × Fsc sampling.
Television Signal Standard	Monochrome or heterodyne NTSC standard 525 line 60 Hz signals.
Recorder Interface	Capstan servo or line lock Helical Scan VTRs.
Window of Correction	...	16 Horizontal lines.
Resultant Time Base Correction*	Video Luminance: ±20 nsec. Video Chrominance: ±2 nsec relative to burst.
K-Factor (2T Pulse)	2% color, 2% monochrome.
Differential Phase	Less than 1.50° at 0.280 V subcarrier.
Differential Gain	Less than 1.50% at 0.280 V subcarrier.
Signal-to-Noise Ratio	...	55 dB (peak-to-peak signal to rms noise) as measured on Rohde and Schwarz noise meter.
Bandwidth, Color	3 dB down at 3.3 MHz.
Bandwidth, Monochrome	Less than 3 dB down at 4.2 MHz.
Color/Mono Compatibility	If burst is not present, monochrome mode is automatically selected.
Lock Time	Color lock within one millisecond after capstan servo VTR has obtained V-lock. Approximately 2 seconds after line lock VTR has reached operating speed.
Processing Amplifier	Reinserts sync, blanking and color burst (color burst deleted on monochrome signals).
Gen Lock Range	Adjustable ±2 μsec.

INPUTS

Input Reference (Gen Lock)	1 V p-p composite video with burst or composite sync and subcarrier.
Input Video	Composite video from VTR, 1 V p-p @ 75 Ohms.
Input D.O.C. Reference	..	R.F. from VTR for drop out compensator, 0.5 V p-p (nominal) @ 75 Ohms.

OUTPUTS

Video	Composite video output, 1 V p-p @ 75 Ohms.
Advanced VTR Sync	For V-lock VTR: Advanced composite sync ±10 lines, 1 V @ 75 Ohms; automatic or manual.
Sync	Horizontal, vertical, composite sync, composite blanking, burst flag; 4 V @ 75 Ohms. Subcarrier; 2 V @ 75 Ohms.

PHYSICAL

Size	48.3 cm (19") wide × 8.9 cm (3.5") high × 48.3 cm (19") deep. Shipped as stand alone unit with rack ears.
Power	Approx. 175 W: 100,120,220,240V, 48-66 Hz.
Weight	35 lbs. (15.9 kg).
Ambient Temperature	...	50°F–104°F (10°–40°C).
Ambient Humidity	10%–80%.

OPTIONS

- *H & V Adjustable Blanking*
- *Fiberglass Shipping Case*

*NOTE: Recorder and tape signal to noise capabilities affect time base stability. A decrease in signal-to-noise ratio below approximately 40 dB will cause an increase in residual time base error.

Specifications subject to change without notice.

THE COMPANY

Harris Video Systems (formerly CVS, Inc.) is located in Sunnyvale, California, U.S.A. Customers include all four major U.S. TV networks, major international networks, independent commercial and educational stations, many duplicating facilities and a large number of educational and industrial organizations worldwide.

As CVS, Harris Video Systems received the coveted Emmy Award for "outstanding achievement in engineering development" in May, 1974. The company has been issued a basic U.S. patent covering the general technique of correcting certain video signals by use of a digital time base corrector.



CVS 590 Digital Time Base Corrector



CVS 590: The most versatile TBC available

The CVS 590 from Harris Corporation is a digital, NTSC TBC that provides the ultimate in signal performance and time base error correction with virtually any type of heterodyne or direct VTR. The key reason for this performance and versatility is the use of a nine-bit, four-times subcarrier (9-bit, $4 \times F_{sc}$) sampling techniques.

In any digital television system, the rate at which the video signal is sampled and the number of digital bits available to describe the video signal are critical. These two parameters establish theoretical limits for such key specifications as K factor, signal-to-noise, differential phase and gain, and bandwidth.

In the case of the CVS 590, four times subcarrier sampling results in significantly improved frequency response and K factor (see Figures 1 and 2). At the same time, the availability of 9-bits, provides a signal-to-noise ratio that offers transparent signal performance—even with the best broadcast VTRs.

Although the increases in picture quality are immediately evident on first generation material, the improved noise and response characteristics of the CVS 590 are especially important with multi-generation dubs. It was for this demanding application that the 9-bit, $4 \times F_{sc}$ system used in the CVS 590 was developed. An added benefit is that the resultant performance characteristics make the CVS 590 immune to obsolescence as newer, even more sophisticated VTRs become available.

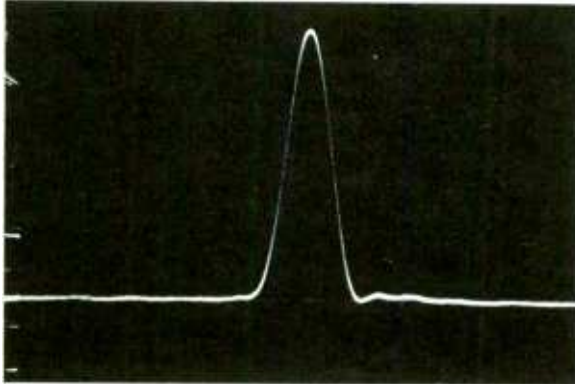

Typical 590 2T pulse response.

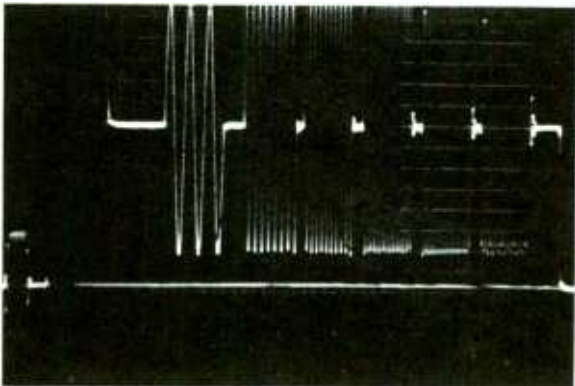

Typical 590 multiburst response.

OPERATION

A typical 590 installation is shown below, illustrating RF carrier hook-up for dropout compensation and VTR vertical drive for automatic vertical centering. Also shown is 3.58 MHz VTR feedback to allow wideband TBC operation with heterodyne signals. (The CVS 590 can also be used with direct signals, such as quadruplex and "C" format VTRs.)

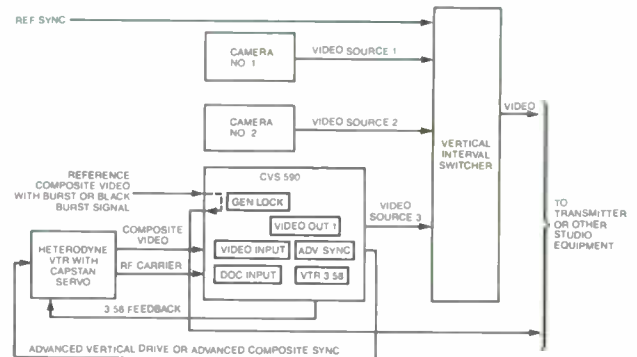

APPLICATIONS

Whenever the ultimate in time base error correction and signal processing is required, the CVS 590 is a perfect fit.

Broadcast

In the studio, the 590's excellent signal-to-noise ratio and wideband frequency response make it a natural mate for the high-performance broadcast machines. Furthermore, it can be used for inexpensive backup recording with V-lock, heterodyne VTRs and still produce broadcast quality video.

CATV

CATV applications benefit from the 590's proc amp with pre-set controls for full signal correction, and from its adjustable gen-lock timing and variable H blanking. The CVS 590 is especially ideal for cable systems moving into premium TV and commercial operation.

ENG, EFP and Post-Production

The CVS 590 provides the flexibility of operating with all recorder formats that ENG, EFP and Post-Production demand in a time base corrector. Add this to the 590's small size and light weight, and you have the perfect combination for field use.

Laboratory Applications

Laboratory users require the highest quality, most transparent signal processor available. The CVS 590's state-of-the-art performance, coupled with its ability to correct video signals from virtually any VTR, make it an obvious choice for this application.

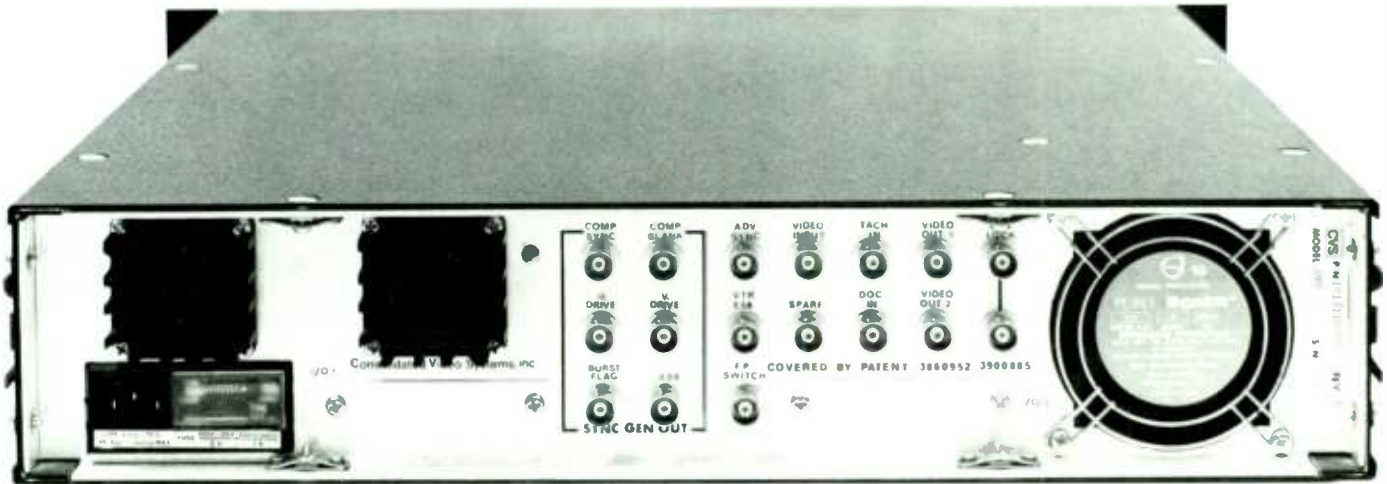

FEATURES

- **VTR Versatility:** Works with heterodyne, "C" format, and quadruplex VTRs to provide a truly cost-effective approach to video signal correction problems.
- **16 Line Memory:** Easily handles large time base errors and allows playback of many formerly unuseable tapes.
- **"Gyrocomp" Memory Organization:** Exclusive feature allows correction of gyroscopic errors without breakup or hue shift.
- **Line-by-Line Velocity Compensation:** Provides the high performance correction required for direct VTRs and other applications with inherently high error rates.
- **Transparent Signal Quality:** Incorporates 3.58 MHz feedback to allow full bandwidth performance with heterodyne VTRs. The 590 never degrades the signal quality of your VTR, be it helical, "C," or quad format.
- **Automatic Advanced VTR Sync:** Monitors off-tape and house sync to correctly position vertical blanking.
- **Digital D.O.C.:** Replaces missing video with corrected color insertion to clean up bad tapes.
- **Variable H Blanking:** Permits the operator to maintain input H&V blanking widths.
- **Internal Ramp Test Generator:** Makes it easy to quickly check A/D and D/A circuitry.
- **Dub-to-Direct:** Allows line-lock VTRs to be dubbed up to "C" format or quadruplex units.
- **Built-In Proc Amp with Preset Controls:** Gives operator complete control over the incoming video signal.
- **Sync Generator Outputs:** Makes available a full set of sync generator drives for facility use.
- **Convenient, Front Panel Operation:** Provides five operator controls: Video Level, Chroma Level, Set-Up, H-Phase and Hue. The first four have preset unity positions to reduce the possibility of misalignment. Secondary controls and switches are behind a sliding cover — easy to get at, but protected from accidental use.
- **Compact Size:** Advanced electronic circuitry makes the CVS 590 exceptionally compact, a key advantage for EFP applications, and a space saver in crowded racks.

OPTIONS

- Quad head-switch amplifier
- Fiberglass shipping case

RELIABILITY & SERVICE

To ensure reliability, each CVS 590 is individually tested before shipment using the toughest quality control standards in the industry. This includes individual testing of each board, plus vibration and heat testing of the finished product.

In addition, the 590's unique "flat pack" design makes all components easily accessible for fast, easy maintenance, testing and troubleshooting — without extender boards. Troubleshooting is further simplified by an internal ramp generator that tests the digital circuitry. An on-line, quick test of the system is also possible with jumpers that allow interchange of the most significant bit with the least significant bit.



The result of this attention to product performance and ease of maintenance is a TBC that stands up to the most demanding operation, backed by a worldwide network of Authorized Distributors and Service Centers.

THE COMPANY

Harris Video Systems (formerly CVS: Consolidated Video Systems, Inc.) is located in Sunnyvale, California, U.S.A. Customers include all four major U.S. TV networks, major international networks, independent commercial and educational stations, many duplicating facilities and a large number of educational and industrial organizations worldwide.

As CVS, Harris Video Systems received the coveted Emmy Award for "outstanding achievement in engineering development" in May, 1974. The company has been issued a basic U.S. patent covering the general technique of correcting certain video signals by use of a digital time base corrector.

**CVS 590
SPECIFICATIONS**

GENERAL

Television Signal Standard	Accepts NTSC or NTSC-type 525-line/60 Hz signal.
Recorder Interface	Any segmented or non-segmented VTR with or without capstan servo, heterodyne or direct color or monochrome.
Window of Correction ...	16 H.
Resultant Time Base Correction:	
Monochrome	± 20 ns.
Direct Color	± 2 ns.
Heterodyne Color	± 3 ns relative to burst.
K Factor, 2T Pulse	1% Mono & Direct Color. 3% Heterodyne Color.
Differential Phase	2° with 40 IRE subcarrier.
Differential Gain	2% with 40 IRE subcarrier.
Signal-to-Noise Ratio (p-p signal to RMS noise)	Greater than 58 dB as measured on Rohde & Schwarz noise meter with 10 kHz highpass and 3.58 MHz subcarrier trap engaged.
Bandwidth, Direct Color, Mono, and Heterodyne Color with 3.58 feedback	± 0.5 dB from D.C. to 4.2 MHz; -1 dB @ 5.0 MHz.
Bandwidth, V-Lock, Heterodyne Color	-3 dB @ 2.5 MHz.
Genlock Range	Advance of 4 μsec, delay of 2 μsec.

INPUTS

Digital Sampling Rate ...	4X Fsc
Quantizing	9 bit
Input Video	0.56 to 1.78 V p-p (1 V nominal into 75 ohms) terminating input.
Input Reference (Genlock)	Composite video with burst 0.3 to 2.0 p-p into 75 ohms, high impedance looping input.
Input D.O.C. Reference	R.F. carrier, 3 MHz to 10 MHz nominal, 0.7 V to 2.0 V into 75 ohms.
Tach Pulse	TTL input 0 to +4.0 V terminated into 75 ohms from segmented VTR.

OUTPUTS

Video Output	One composite and one selectable composite/non-composite, 1 V p-p nominal into 75 ohms.
Sync	H Drive, V Drive, Sync, Blanking and Burst Flag, 4.0 V p-p into 75 ohms, subcarrier 2.0 V p-p into 75 ohms.
Advanced VTR Sync ...	Vertical drive or composite sync (selectable) 4.0 V p-p into 75 ohms.
VTR 3.58	Regenerated 3.58 MHz subcarrier containing time base errors of input video signal, 1.0 V p-p (minimum) into 75 ohms.
Headswitch Location Signal	Head switching pulse for segmented VTR, 3 V p-p.

PHYSICAL

Ambient Temperature	10°C to 40°C (50°F to 104°F).
Ambient Humidity	10% to 80%
Power	150 W @ 100, 120, 220 or 240 V; 50 or 60 Hz.
Weight	15.9 Kg (35 lbs.).
Dimensions	48.3 cm (19") W × 8.9 cm (3.5") H × 48.3 cm (19") D.

OPTIONS

- Quad head-switch amplifier
- Fiberglass shipping case

* Recorder and tape signal-to-noise capabilities affect time base stability. A decrease in signal-to-noise ratio below approximately 40 dB will cause an increase in residual time base error.



HARRIS

CVS 506 Video Time Base Corrector

Harris Video Systems



A low cost, high quality TBC for CCTV, CATV and MATV

The CVS 506 is specifically designed and priced for heterodyne VTR users who don't need broadcast stable outputs. Using the latest CCD (charge coupled device) technology, the CVS 506 combines superb electronic specifications with simple operation to significantly reduce, or eliminate, skew, jitter, flagging and other picture distortions. It can be used with any heterodyne VTR, including 3/4" U, Beta and VHS formats.

In addition, the reliability and dependability of the CVS 506 are ensured because it is manufactured by Harris Video Systems, a company with more time base correctors in use, worldwide, than any other manufacturer.

FEATURES

- **Excellent Electronic Specifications**
- **1H Correction Window:** Floating window tracks the VTR to remove multi-line errors.
- **Anti-Breakup Circuit:** Ensures proper window tracking rate. For good tapes, the window tracks slowly to remove even low frequency errors. As errors increase and become abrupt at the edges of the window, the tracking rate gradually changes so that, even with very poor quality tapes, the skew can still be removed.

FEATURES (cont.)

- **Built-in Proc Amp:** Strips off old sync, cleans it and reinserts the cleaned up sync, and burst, with proper rise and fall times. Interlace and non-interlace sync are processed automatically.
- **Automatic Color/Mono Selection:** Simplifies operation by eliminating the need for a separate control.
- **Automatic Bypass:** Unit is automatically bypassed when power is turned off, or when there is a power failure.
- **Simple Front Panel Controls:** Four buttons provide easy, fast adjustments. Controls include: Video Gain with a $\pm 40\%$ range; Set-up with a ± 15 IRE range; Chroma Gain with a range of $\pm 40\%$ and Hue Control with a $\pm 30^\circ$ range.
- **Compact Design:** The CVS 506 is only 3 1/2" high by 19" wide, and weighs only 10 pounds. It can be easily installed, even in the most crowded facilities.

CVS 506

SPECIFICATIONS

GENERAL

Input/Output Signals	1 Volt p-p composite video, heterodyne color or monochrome
Signal to Noise Ratio	60 dB p-p signal to RMS noise
Differential Phase	1°
Differential Gain	2%
Tilt (60 Hz)	1%
Bandwidth	2.5 MHz luminance
K Factor (2T Pulse)	4%
Lock Up Time	250 msec
Power	117 V $\pm 10\%$ or 235 V $\pm 10\%$ 50 or 60 Hz (requires internal wiring selection)
Dimensions	3 1/2" (8.9cm) H \times 19" (48.3cm) W \times 13 1/2" (34.3cm) D
Weight	10 lbs. (4.5kg)

CONTROLS

Video Gain	Unity ± 3 dB
Setup	Unity ± 15 IRE
Chroma Gain	Unity ± 3 dB
Hue	Unity $\pm 30^\circ$
Color/Mono	Automatic selection based on 20 IRE p-p burst to engage color mode and 15 IRE p-p burst to disengage.

THE COMPANY

The CVS 506 is just one of the ways Harris uses modern analog and digital techniques to make video productions look better. Besides being the acknowledged world leader in time base correction, Harris also manufactures other advanced products for video signal processing, including the CVS 630 Frame Synchronizer and the Harris EPIC™ computer-aided editing system.

Harris customers include all major U.S. Networks (ABC, CBS, NBC and PBS), major international networks, independent commercial and educational stations, most duplication facilities and a large number of CATV, educational and industrial organizations worldwide. All Harris products are backed by an international network of factory authorized sales and service distributors. For a demonstration of the CVS 506, or any other Harris product, contact your local Harris Video Systems distributor.



HARRIS

CVS 517 PAL/SECAM Digital Video Time Base Corrector

Harris Video Systems



CVS 517: the ideal TBC for PAL/SECAM

The CVS 517 is a broadcast quality, PAL (and optional SECAM) digital time base corrector made and priced to give users of non-segmented, heterodyne VTRs all the proven advantages of modern digital video processing. It works with 625/50 monochrome and color heterodyne video signals from helical VTRs to give both broadcast and non-broadcast video users expanded creative versatility for ENG, teleproduction, studio VTR backup and much more. Based on the field proven experience of over 3000 CVS digital TBCs, the CVS 517 comes with features that, before, were found only in units costing up to twice as much.

OPERATION

Operationally, the Model CVS 517 accepts an input video signal, digitizes it and stores it. The signal is then clocked out at a corrected rate and referenced to either an external or internal sync generator. The result is a time base corrected video signal.

Capstan Servo VTR

When the input signal to CVS 517 is a heterodyne type recording from a capstan servo VTR, the output signal is a broadcast stable, fully interlaced and color framed video signal.†

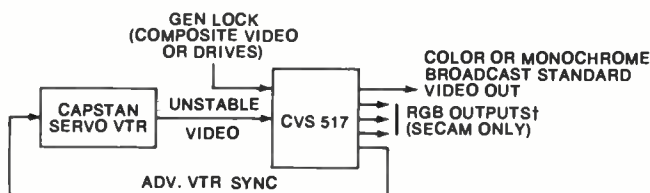

Note: For DOC, the CVS 517 requires R.F. carrier from VTR.

Non-Capstan Servo VTR

When the input signal to the CVS 517 is a heterodyne type recording from a non-capstan-servo VTR, the output signal is a stabilized color signal.† Dub-to-quad capability is also available at the flip of a switch (optional).

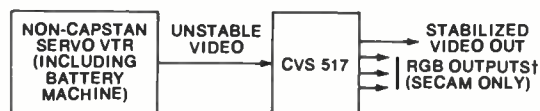

Note: For DOC, the CVS 517 requires R.F. carrier from VTR.

625/50 Monochrome Signal

When the input signal to the CVS 517 is a wideband 625/50 monochrome signal, the output is a stabilized signal with bandwidth of 5 MHz.

†In SECAM, CVS 517 has time base corrected PAL and synchronized RGB outputs. For composite time base corrected SECAM video out signal, feed RGB outputs through a SECAM encoder.

APPLICATIONS

The CVS 517, with its advanced features and ease of operation, opens up entire new application areas for the use of video, from Field Production to Closed Circuit Television distribution. Listed below are just a few of the uses for this versatile TBC.

Electronic Journalism

The CVS 517 plays an integral part in field production applications, like Electronic Journalism. You can use a relatively inexpensive, portable VTR for remote coverage, documentaries, news, commercials and special features. Additionally, the built-in sync generator gives you field production capability, field editing and mixing of sources, and direct feedback to the studio via microwave.



Back-Up Operations At The Studio

Instead of using an expensive, direct color VTR for back-up recording requirements, use the CVS 517 with an inexpensive, V lock heterodyne VTR. This allows you to make better and more efficient use of your expensive machines to do in-house production. Overall savings can be significant.



General Playback, Dubbing, Editing & Problem Tape Correction

The CVS 517 effectively handles many chores related to broadcast, cable and closed circuit TV operations, whether monochrome or heterodyne color. Among other things, it ensures high picture quality playback for special review, training or CCTV distribution systems. It also gives you the ability to do quality dubbing or editing. This latter application is where the full signal correction potential of the CVS 517 is realized. With the CVS 517, problem tapes no longer need to be a problem.

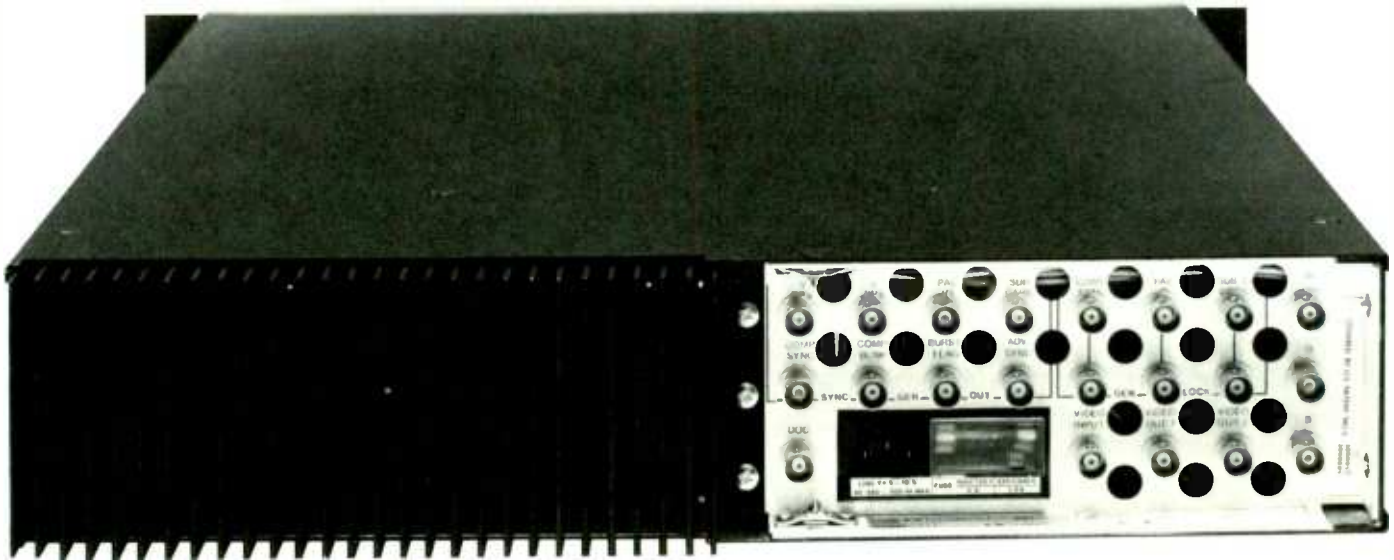

FEATURES

- **"Gyrocomp" Memory Organization** — allows correction of large time base errors (such as gyroscopic errors), without breakup, to make ENG tapes broadcast compatible. Standard memory has a 2 horizontal lines correction window.
- **Improved Bandwidth** — improved input circuitry in the optional 16 line unit allows tapes from new "high band" 3/4" cassette recorders to be processed without picture degradation.
- **Digital Color Averaging** — lowers chroma noise by 3 dB and reduces velocity errors by using digital variable delay lines to average chroma.
- **Compact Size** — advanced electronic circuitry makes the CV5 517 exceptionally compact, a key advantage for field production. Height is just 8.9 cm (3-1/2"); weight is only 15.9 Kg (35 lbs).
- **Convenient, Front Panel Operation** — controls have a pre-set unity position to reduce the possibility of misalignment. Secondary controls and switches are behind a sliding cover — easy to get at but protected from accidental use.
- **One Cable Gen Lock Sync Generator with Outputs** — simplifies system interface and maintains 25 Hz PAL offset in all modes.
- **Built-in Color Dropout Compensator** — cleans up "dirty" tapes.
- **Built-in Processing Amplifier** — provides clean, stable outputs.
- **Digital Chrominance-to-luminance Delay Adjustment** — compensates for a common heterodyne VTR defect.
- **VTR Versatility** — works with Capstan Servo and Non-Capstan Servo VTRs.

OPTIONS

SECAM

The SECAM option allows the CV5 517 to accept heterodyne or direct color inputs from non-segmented SECAM VTRs, and provides PAL to SECAM and SECAM to PAL transcoding.

When the input signal is from a vertical lock VTR, the output signal will be broadcast stable. When the input signal is from a mains lock VTR, the output will be a stabilized signal. RGB outputs are available on the back panel for routing to RGB switching systems or to an external, customer supplied SECAM encoder.

OPTIONS (cont.)

PAL/SECAM Image Enhancer/Noise Reducer

The Image Enhancer/Noise Reducer provides a total of 5 dB of noise reduction in both the luminance and chroma channels and horizontal enhancement. The level of noise reduction and enhancement is adjustable. An Enhancer on/off switch is located behind the sliding panel on the front of the TBC.

Increased Memory

A 16 line memory is available for special "worst case" applications. This ± 8 line correction range further minimizes the effect of gyroscopic errors.

Dub-to-Direct

This option allows PAL mains lock or remote VTRs to be dubbed to direct color video recorders such as quadruplex, type "C" and BCN.

Fiberglass Carrying Case

Unique packaging and minimal weight (11.4 Kg) make the CV5 517 easy to take anywhere. With this specially designed fiberglass carrying case, the unit is fully protected — a special advantage when doing field productions.

Reliability

The unique "flat-pack" design of the CV5-517 makes all components easily accessible for fast, easy maintenance, testing and troubleshooting.



Each CV5 517 is individually tested before shipment using the toughest quality control in the industry. This includes individual testing of each board. Units are then vibration tested, baked out for 24 hours and checked by inspectors who are independent of manufacturing. The result? A TBC that stands up to the most demanding operation, backed by a worldwide network of distributors and service centers.

CVS 517 PAL/SECAM SPECIFICATIONS

GENERAL

Television Signal Standard	Accepts monochrome, heterodyne PAL or SECAM standard 625 line 50 Hz signals.
Recorder Interface	Requires signal from capstan servo or mains lock heterodyne VTR.
Window of Correction Resultant Time Base Correction*	2 horizontal lines (16L optional). Video luminance: ± 20 nsec. Video chrominance: ± 2 nsec relative to burst.
K-Factor (2T Pulse)	4% color, 2% monochrome.
Differential Phase	Less than 1.5° at 0.280 V subcarrier.
Differential Gain	Less than 1.5% at 0.280 V subcarrier.
Signal-to-Noise Ratio	52 dB (peak-to-peak video to rms noise) as measured on Rohde and Schwarz noise meter.
Bandwidth, Color Mode	
2 Line Window	± 1 dB, 50 Hz to 2.5 MHz. Less than 3 dB down at 3.0 MHz.
16 Line Window	± 1 dB, 50 Hz to 3.0 MHz. Less than 3 dB down at 3.5 MHz.
Bandwidth, Monochrome Mode	Less than 3 dB down at 5.5 MHz.
Color/Mono Compatibility	If burst is not present, the CVS 517 automatically selects mono mode.
Lock Time	Color lock within one millisecond after capstan servo VTR has obtained V-lock. Approximately 2 seconds after line lock VTR has reached operating speed.
Processing Amplifier	Reinserts sync, blanking and color burst (color burst deleted on monochrome signals).
Frame Lock	Will automatically frame lock segments edited randomly at vertical interval.
Gen Lock Range	Adjustable $\pm 2 \mu\text{sec}$.

INPUTS

Input Reference (Gen Lock)	1 V p-p composite video with burst or composite sync, subcarrier and PAL, I.D. Pulse.
Input Video	Composite video, 1 V p-p into 75 Ohms.
Input D.O.C. Reference	R.F. from VTR for drop out compensator, 0.5 V p-p (nominal) into 75 Ohms.

OUTPUTS

Video (2)	Composite video output, 1 V p-p into 75 Ohms (one output bypassable). RGB (SECAM option only)—separate Red, Green and Blue outputs, composite or noncomposite.†
Advanced VTR Sync	For V-lock VTR: advanced composite sync ± 9 lines, 1 V into 75 Ohms.
Sync	H & V drive, composite sync, composite blanking, burst flag, PAL I.D. Pulse, 4 V into 75 Ohms. Subcarrier 2 V into 75 Ohms.

PHYSICAL

Size	48.3 cm (19") wide \times 8.9 cm (3.5") high \times 48.3 cm (19") deep. Shipped as stand-alone unit with rack ears.
Power	Approx. 175 W: 100, 120, 220, 240V, 48–66 Hz.
Weight	15.9 Kg. (35 lbs.).
Ambient Temperature	10° to 40° C.
Ambient Humidity	10% to 80%.

OPTIONS

- SECAM or Dub-to-Direct
- PAL/SECAM Image Enhancer/Noise Reducer
- H & V Adjustable Blanking
- 16 Horizontal Line Memory
- Fiberglass Shipping Case

*Note: Recorder and tape signal-to-noise capabilities affect time base stability. A decrease in signal-to-noise ratio below 40 dB will cause an increase in residual time base error.

†In SECAM, CVS 517 has time base corrected PAL and synchronized RGB outputs. For composite time base corrected SECAM video out signal, feed RGB outputs through a SECAM encoder.

THE COMPANY

Harris Video Systems (formerly CVS, Inc.) is located in Sunnyvale, California, U.S.A. Customers include all four major U.S. TV networks, major international networks, independent commercial and educational stations, many duplicating facilities and a large number of educational and industrial organizations worldwide.

As CVS, Harris Video Systems received the coveted Emmy Award for "outstanding achievement in engineering development" in May, 1974. The company has been issued a basic U.S. patent covering the general technique of correcting certain video signals by use of a digital time base corrector.

CVS 507 PAL Video Time Base Corrector

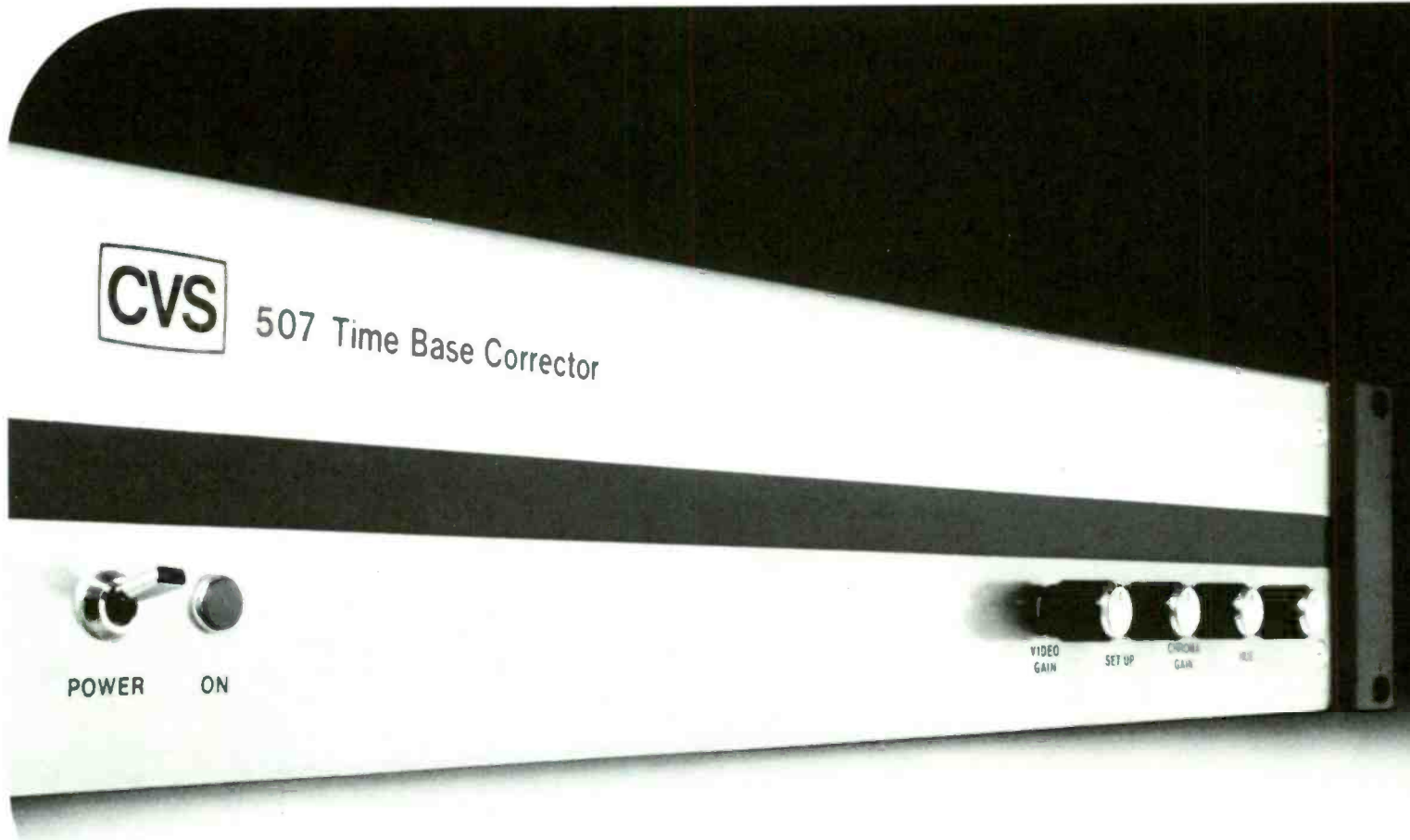

A low cost, high quality TBC for CCTV

The CVS 507 is specifically designed and priced for heterodyne VTR users who don't need broadcast stable outputs. Using the latest CCD (charge coupled device) technology, the CVS 507 combines superb electronic specifications with simple operation to significantly reduce, or eliminate, skew, jitter, flagging and other picture distortions. It can be used with any heterodyne VTR, including 3/4" U, Beta and VHS formats.

In addition, the reliability and dependability of the CVS 507 are ensured because it is manufactured

Harris Video Systems, a company with more time base correctors in use, worldwide, than any other manufacturer.

FEATURES

- **Excellent Electronic Specifications**
- **1H Correction Window:** Floating window tracks the VTR to accommodate multi-line errors.
- **Anti-Breakup Circuit:** Ensures proper window tracking rate. For good tapes, the window tracks slowly, to remove even low frequency errors. As errors increase and become abrupt at the edges

of the window, the tracking rate gradually changes so that, even with very poor quality tapes, the skew can still be removed.

- **Built-in Proc Amp:** Strips off old sync, cleans it and reinserts the cleaned up sync, and burst, with proper rise and fall times. Interlace and non-interlace sync are processed automatically.
- **Automatic Color/Mono Selection:** Simplifies operation by eliminating the need for a separate control.

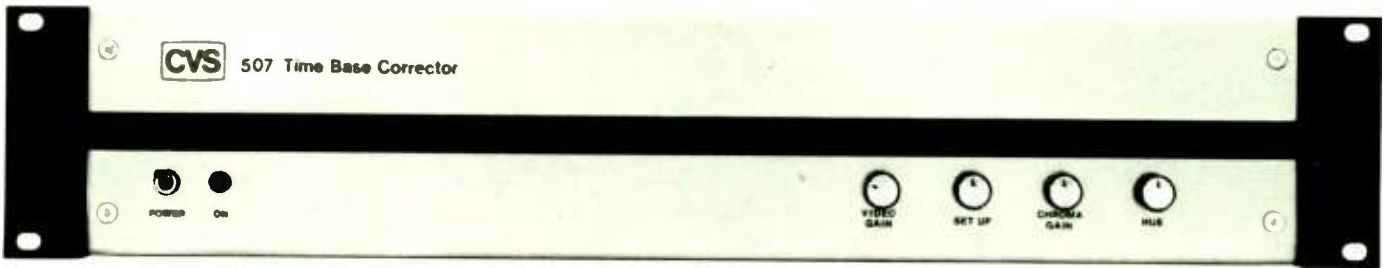

FEATURES (cont.)

- **Automatic Bypass:** Unit is automatically bypassed when power is turned off, or when there is a power failure.
- **Simple Front Panel Controls:** Four buttons provide easy, fast adjustments. Controls include: Video Gain with a $\pm 40\%$ range; Set-up with a ± 15 IRE range; Chroma Gain with a range of $\pm 40\%$ and Hue (Phase) Control with a $\pm 30^\circ$ range.
- **Compact Design:** The CVS 507 is only 8.9 cm high by 48.3 cm wide, and weighs only 4.5 kg. It can be easily installed, even in the most crowded facilities.

SPECIFICATIONS

General

Input/Output Signals	1 Volt p-p composite video, heterodyne PAL color or monochrome
Signal to Noise Ratio	57 dB p-p signal to RMS noise
Differential Phase	2°
Differential Gain	2%
Tilt (50 Hz)	1%
Bandwidth	3.0 MHz luminance
K Factor (2T Pulse)	4%
Lock Up Time	250msec
Power	235 V $\pm 10\%$ or 117 V $\pm 10\%$ 50 or 60 Hz
Dimensions	8.9cm (3½") H x 48.3cm (19") W x 34.3cm (13½") D.
Weight	4.5kg (10 lbs.)

Controls

Video Gain	Unity ± 3 dB
Setup	Unity ± 15 IRE
Chroma Gain	Unity ± 3 dB
Hue	Unity $\pm 30^\circ$
Color/Mono	Automatic selection based on 20 IRE p-p burst to engage color mode and 15 IRE p-p burst to disengage.

The Company

The CVS 507 is just one of the ways Harris uses modern analog and digital techniques to make video productions look better. Besides being the acknowledged world leader in time base correction, Harris also manufactures other advanced products for video signal processing, including the CVS 630 Frame Synchronizer and the EPIC™ computer-aided editing system.

Harris customers include all major U.S. Networks (ABC, CBS, NBC and PBS), major international networks, independent commercial and educational stations, most duplication facilities and a large number of CATV, educational and industrial organizations worldwide. All Harris products are backed by an international network of factory authorized sales and service distributors. For a demonstration of the CVS 507, or any other Harris product, contact your local Harris Video Systems distributor.

HVS 630 Digital Frame Synchronizer



HARRIS

HVS 630: A powerful framestore—and more!

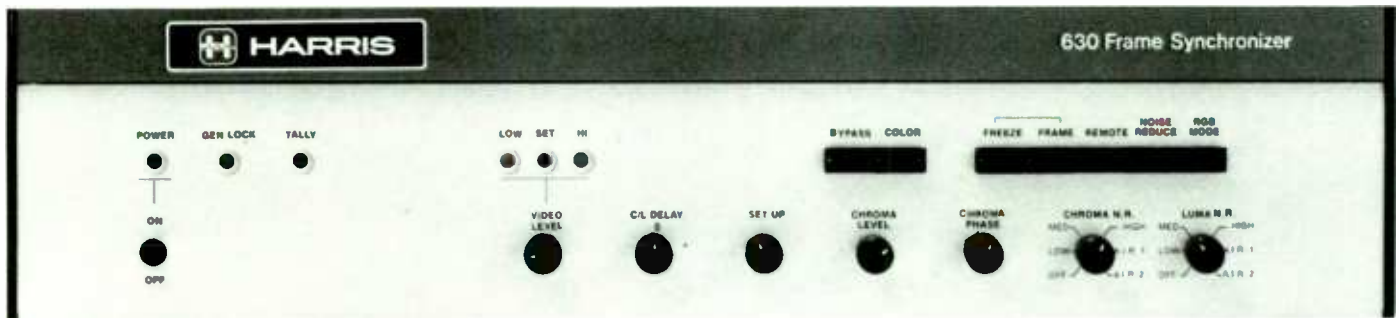

With the introduction of the HVS 630, video users can now have a combination of signal processing capabilities that have never before been available in a single instrument.

First of all, the HVS 630 is a superb synchronizer. It locks non-synchronous video sources—satellite, microwave, portable camera, studio feed or heterodyne VTRs—to your television system with precise accuracy.

Superb synchronization, however, is just part of what the HVS 630 makes possible. Its combination of features, versatility and economy puts it in a class by itself. In addition, the 630 features an exclusive built-in, digital I/O interface that lets you plug in to future developments in digital video technology. No other commercial synchronizer can match this combination of performance and flexibility.

A New Digital Architecture

The 630 departs from other digital systems by using a unique 8 bit system that processes the video signal in *component* form instead of in *composite* form.

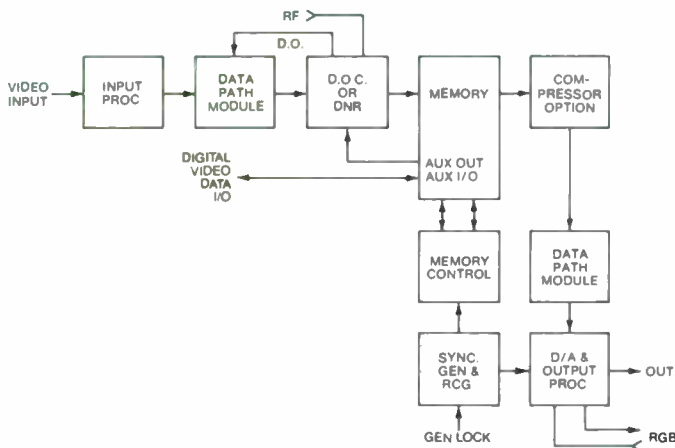

Figure 1: Basic Block Diagram HVS 630 Frame Synchronizer

In operation, when a signal is received, the 630 captures it, digitizes it in component form and stores it in a modern, 16K RAM-based frame memory. Then, using a PROM-actuated memory controller, it reads out the signal in precise synchronization and re-codes it in correct vertical, horizontal and color synchronization.

This component coding technique, already thoroughly proven in over 1000 HVS digital time base correctors, results in a system that is inherently immune to color phasing problems, "cycle jump" and horizontal picture shift. The 4 field (NTSC) or 8 field (PAL) color sequence is always correctly maintained. This approach also allows separate manipulation of the chroma and luma components, so that you can take maximum advantage of noise reduction and other picture improvement technology.

Time Base Correction

Outstanding time base correction is a built-in feature of the 630. Because we originated the digital TBC, and are still the world leader, our engineers have been able to incorporate the knowledge gained from more than 4000 digital TBCs now in use worldwide. As a result, you get a time base corrector that operates smoothly and efficiently. In fact, its performance is actually superior to stand-alone TBCs.

Special Effects

Another advantage of the 630 is an outstanding effects capability. Picture freeze (field or frame) is standard. Other effects, like video compression and positioning (see facing page), are available as options.

Digital Noise Reduction

To even further expand the capability of the 630, a digital noise reducer is available as an economical option. Designed to complement the built-in TBC, this option is described more fully on the facing page.

Future Expansion

Besides offering all of the performance features described above, the 630 has been specifically designed to encourage and permit digital interface. The Direct Memory Access I/O port can be custom-designed to provide virtually limitless applications: digital graphics . . . real time picture analysis . . . multiple picture effects . . . digital still store . . . and more.

FEATURES

Automatic Mode Switching: Operator attention is not needed because stable and unstable inputs can be intermixed *without* switching from "normal" to "TBC" modes.

Exceptional Write Clock Range: Ensures that off-speed tapes, or tapes with gyro error, will play back with proper correction.

"Dual Mode" Hot Switching: Exclusive circuitry permits switching of asynchronous input sources without disrupting output video. The 630's sensitivity to incoming video irregularities is adjustable. This puts the operator in control of what constitutes a freeze condition. Less than perfect video can be made to "slide thru" while, under other conditions, the operator may choose to make the 630 more discriminating.

Compensation for Lost Video: If input video is lost, the 630 either automatically freezes on the last good picture or cuts to black, depending on the setting of a board-level switch. In the "cut to black" mode, the 630 momentarily freezes to verify actual loss of video and then cuts to black.

Picture Freeze: Increases production versatility by providing front panel selectable field or frame freeze with no reduction in bandwidth. Pictures are crisp and sharp — even in "freeze."

High Noise Immunity: Built-in circuitry extracts maximum information from even the poorest quality tapes; signals with severe hum and noise pass through without difficulty.

RGB Mode: A unique RGB mode, selectable from the front panel, allows the 630 to be used with a number of video processing devices already available, such as encoders, enhancers, and color correctors. It also provides RGB IN and OUT for "next year's" devices.

Convenient Front Panel Operation: Operating modes are push-button selectable, and all operating controls are on the front panel. Since controls are preset/variable, a "standard" setting is instantly achievable. Secondary controls are board level to reduce the chance of inadvertent mis-adjustments.

Easy Maintenance: The use of plug-in cards for most circuitry makes maintenance and/or service of the 630 simple and fast. A built-in test generator makes troubleshooting easy.

Tested Reliability: Outstanding reliability is achieved for the 630 through a combination of careful design and thorough testing, using some of the most stringent quality assurance standards in the industry.

OPTIONS

Video Compressor/Positioner/Effects Unit

This remotely located package allows reduction of a synchronous or non-synchronous video input to 1/4 of its normal size, and location of it, frozen or active, anywhere on the video screen by joystick control. Further, there are eight preset locations that can be selected by pushbutton. (Three of these positions can be operator determined by joystick selection.) Positioning and freeze effects can also be accomplished full screen.

A key signal that follows the compressed output; auto-return-to-center; axis-only-drive; and offscreen substitution complete an effects unit that provides imaginative production tools in a cost effective package.

Digital Noise Reducer

The flexibility of the unique memory architecture in the 630 makes Digital Noise Reduction (DNR) an economical plug-in option rather than an expensive, separate add-on.

Ten dB of noise reduction is readily achievable by the HVS 630 DNR, without the motion artifacts and resolution loss common to other noise reduction devices. And, since not all signals have the same kind of noise, the 630 DNR has separate controls for luminance and chroma noise reduction. As a result, the achievement of quiet chroma no longer means over-correction of the luminance and the resulting "soft" look.

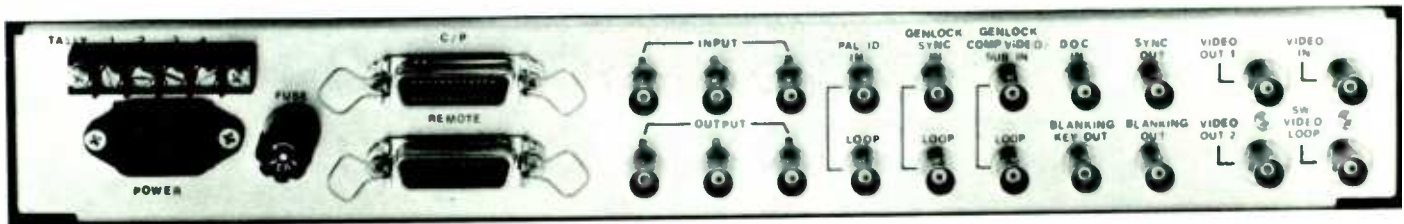

HVS 630 SERIES SPECIFICATIONS

GENERAL

Signal Inputs

Video	.1 V p-p composite, stable interlaced or unstable heterodyne. 75 ohm terminating.
Genlock	.1 V p-p composite video or composite sync, subcarrier and (625 only) PAL pulse. High impedance looping.
D.O.C.	.1 V p-p R.F., 75 ohm terminating
RGB	.0.7 V ea, 75 ohm terminating

Signal Outputs

Video #1	.1 V p-p composite, by-passable
Video #2	.1 V p-p composite
RGB	.0.7 V each
Sync & Blanking	.4 V p-p

Stability

Residual luma TBE	± 7 nsec with 50 dB S/N input signal ± 20 ns with 40 dB S/N input signal
Residual chroma TBE	$\pm 1^\circ$ with 50 dB S/N input $\pm 4^\circ$ with 40 dB S/N input

Performance

Video bandwidth $\pm .5$ dB from 0 to 4.0 MHz; -3 dB @ 4.2 MHz

S/N ratio p-p signal to RMS noise, R/S noise meter with bandpass filter, S.C. Trap & 10 kHz LPF	57 dB (ave)
Differential phase	$\pm 1.5^\circ$
Differential gain	$\pm 1.5\%$
2T K factor	1%
C/L delay	17 ns max.

Physical & Electrical

Dimensions	10.5" (26.7 cm) H x 19" (48.3 cm) W x 22" (55.9cm) D
Weight	.50 lb (22.7 kg)
Ambient temperature	10° - 40° C
Humidity	10%-90% non-condensing
A.C. voltage	115 \pm 10%; 50/60 Hz
A.C. power	350 W

IRIS Digital Still Store

The HVS 630 is a key component in the IRIS Digital Still Store System, another Harris Video Systems product. IRIS puts as many as 5800 stills on line for multiple user access in milliseconds. Inputs can be from photographic slides, artwork, film, VTRs, character generators, network feeds and live cameras. Provision is even made for tie-in with studio automation facilities.

Harris also manufactures the world's most complete line of time base correctors, and EPIC™, a powerful computer-aided editing system for use with multiple VTRs. For more information about the HVS 630 and other Harris Video Systems products, contact HVS or your local authorized distributor.



HARRIS BROADCAST MICROWAVE EQUIPMENT FOR THE TOTAL SYSTEM

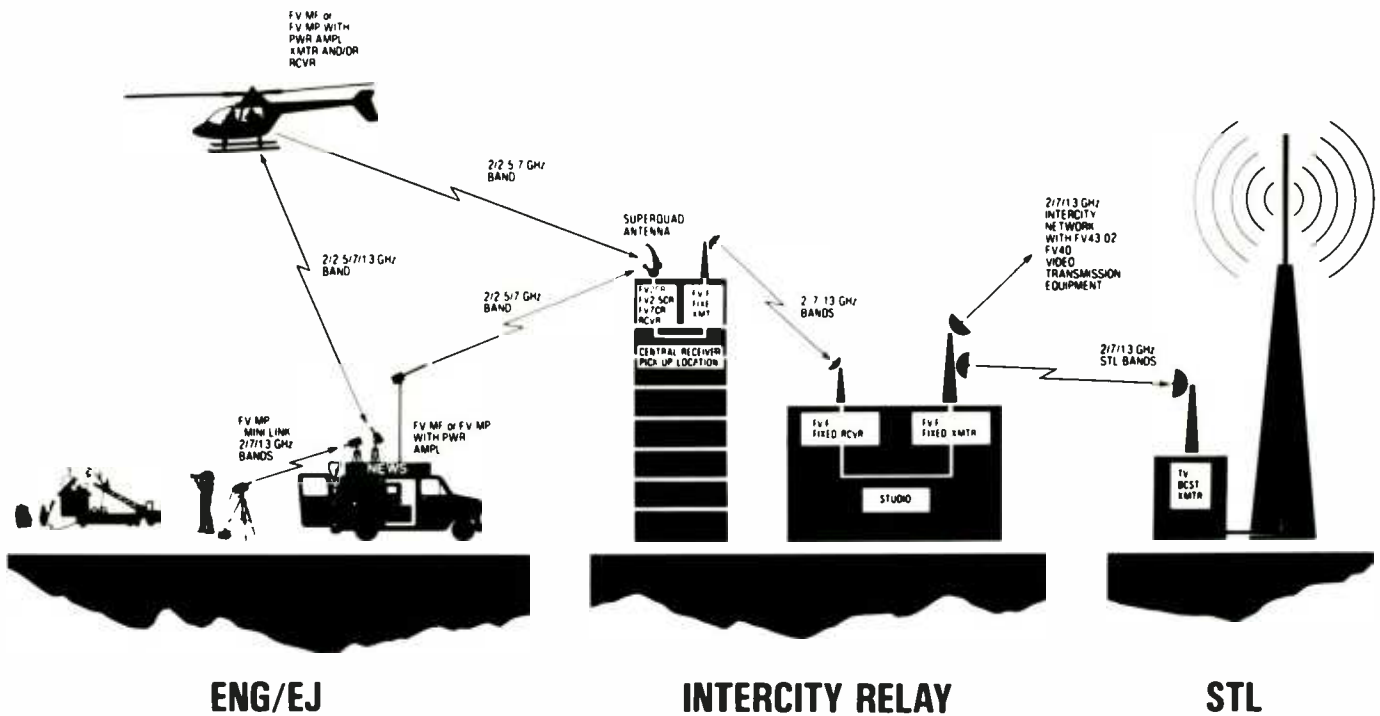

GLOBAL IX™

**The Only Portable Video
Microwave Transmitter You'll
Need in All the World.**



Farinon Video introduces the only truly universal portable video microwave transmitter designated GLOBAL IX (FV2/2.5G). For the first time there's a single portable transmitter capable of covering any 2-GHz frequency plan in the world.

With the unique GLOBAL IX wideband transmitter, you can select more channels than ever before—up to 55 channels in each of 16 different frequency plans. RF channels can be selected locally or remotely.

You'll wonder how such a compact transmitter can provide 3 watts of wideband power. But if that's not enough, there's an auxiliary 12-watt power amplifier available too. And the transmitter interface can be either baseband video or true 70-MHz heterodyne.

Two audio channels with programmable subcarrier frequencies can be transmitted simultaneously. And you have the choice of line level or microphone level for either channel.

To simplify maintenance, the GLOBAL IX portable transmitter has built-in diagnostics. Problems can be quickly diagnosed by monitoring the indicators on a remote channel selector or a separate display unit.

You can power the transmitter from AC or a standard power belt—or even a car battery. What's more, you won't find a more rugged or environmentally reliable transmitter no matter where your crew takes it.

This unique portable video microwave transmitter is representative of the state-of-the-art products in the all-new GLOBAL IX series. Another example of Farinon Video's quest to provide superior video transmission equipment for use throughout the world.

TRANSMITTER SPECIFICATIONS

Designation	FV2/2.5G
Frequency Range	1900-2700 MHz
Frequency Stability	± 0.005%
Output Power	3 watts (+ 34.8 dBm)
Primary Power Sources	115/230 Vac or +10.5 to +16 Vdc
Weight	6.8 kg (15 lbs)
Operating Temperature (Case)	− 30° to + 60°C (− 25° to +140°F)

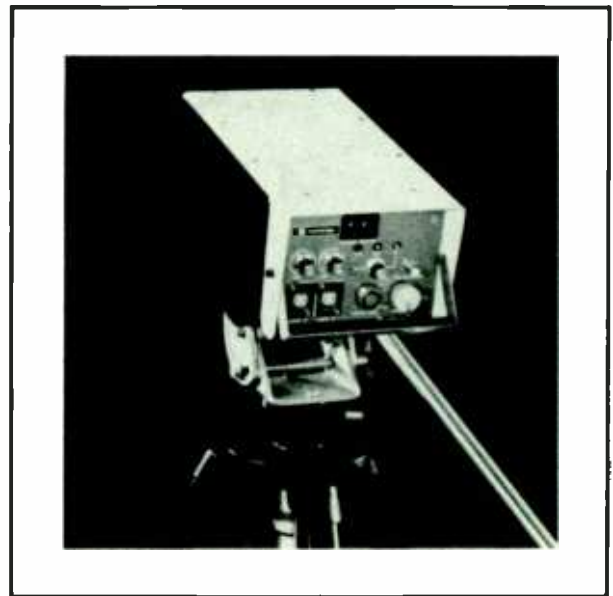

FEATURES

- The GLOBAL IX transmitter is capable of covering any 2-GHz frequency plan in the 1900-2700-MHz range.
- Compatible with NTSC or CCIR Recommendations.
- Up to 16 internally stored frequency plans (55 channels per plan) in 50-kHz increments.
- Local or remote channel selection is available. During the frequency selection, the GLOBAL IX transmitter's RF output is muted to prevent RF interference.
- Two FM program channels available with programmable subcarrier frequencies. The subcarrier frequencies can be set to any NTSC or CCIR frequency between (4.83-8.71 MHz).
- Configured to accept either a standard video line input (1V, peak-to-peak) or a 70-MHz IF input. In addition, the FM channels will accept adjustable microphone inputs.
- Mechanically constructed for operation in extreme environmental conditions and helicopter applications. Multilevel shielding is provided for RFI environments.
- Remote control and monitoring provisions available. The following functions can be controlled from a remote location: Frequency Selection, ON/OFF, and Standby.
- Connectorization of units allows quick interchangeability of spares.

FV40 video transmission equipment for microwave relay or cable systems

FEATURES

- Plug-in Video Terminal Equipment Units for Flexible Baseband and Heterodyne System Arrangements
- Video Impedance and Level Coordination
- 70-MHz Modulation and Demodulation
- Sub-carrier Channels for Program Audio
- Orderwire and Alarm Sub-carrier Transmission Channels
- Clamper Amplifiers
- Radio System Noise and Continuity Pilot Monitors
- Options for 525-Line NTSC, or 625-Line Operation with PAL, PAL-M or SECAM Color Systems.

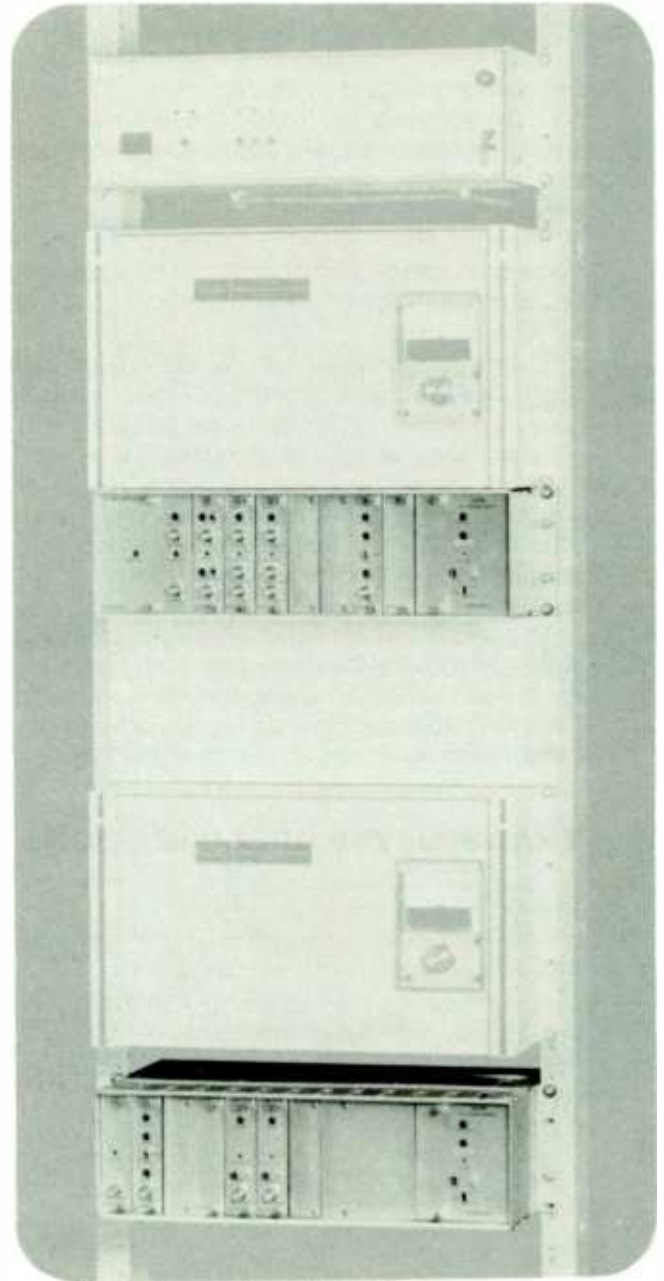

Farinon FV7F IF Heterodyne Microwave Radio terminal; power supply and transmitter above, receiver below (all shown shaded), with corresponding FV40 Video Transmission Equipment shelves.

SYSTEM DESCRIPTION

Farinon FV40 Video Transmission Equipment offers a convenient and flexible method of providing video input/output functions and of adding auxiliary functions to IF heterodyne or baseband radio relay and cable video systems.

The FV40 system may be applied to Farinon microwave radio systems as ordered from the factory, or may be added to standard-interface radio or cable systems of any manufacture. All FV40 equipment interfaces with conventional line connections.

Basic elements of the system are the equipment shelves and the individual plug-in functional units. The shelves provide mechanical support and electrical connections; the plug-in units provide the individual circuits and may be added in arrangements or combinations to meet individual needs. Shelves may operate from 115/220 Vac or from -24, -48 or -21 Vdc.

Equipment reliability is emphasized throughout, with solid mechanical design, conservative use of proven circuit components and generous provision of test points, alarms and back-up functions.

Block diagrams of typical heterodyne and typical baseband repeater systems are shown in Figure 3. FV40 shelves with installed units for a baseband radio system are shown in Figures 1 and 2.

Functional Units

- **Video input and output units** — provide level and impedance coordination, video emphasis,* video presence detection and alarm, and phase-equalized low-pass filters.* The input unit also provides a 1-volt p-p line-up oscillator and continuity pilot.* The output unit provides for video squelch.
- **70-MHz Modulator and Demodulators** — stable, wideband, low distortion modems. The modulator is phase-locked to a crystal.
- **Audio subcarrier channels** — high performance and flexible FM audio channels for program transmission above video, with frequency options for U.S., Canadian and CCIR applications, and integral impedance and emphasis options. Channels may also be utilized for frequency-division multiplexed voice or data transmission.
- **Orderwire channels** — fully synchronous AM channels for party-line orderwire, alarm and control and general administrative transmissions on heterodyne or baseband repeated systems. Audio drop and insert shelf is available.

- **Clamper Amplifiers** — modern, gated-feedback clampers removing low-frequency noise and distortion, with continuously variable 0 — 15 dB gain and strap-selectable balanced or unbalanced input and output.
- **Message-Service Interface Units** — with message emphasis for up to 1800 voice channels.* Interfaces with voice and data multiplex for emergency message restoration, parallel-path message/video routing, etc.
- **Radio system monitors** — monitors continuity pilot* and quantitative system noise, and generates alarms.
- **Power supplies** — optional 115/220 Vac, -24 Vdc or -48 Vdc. Each supply will power a complete transmit or receive shelf.

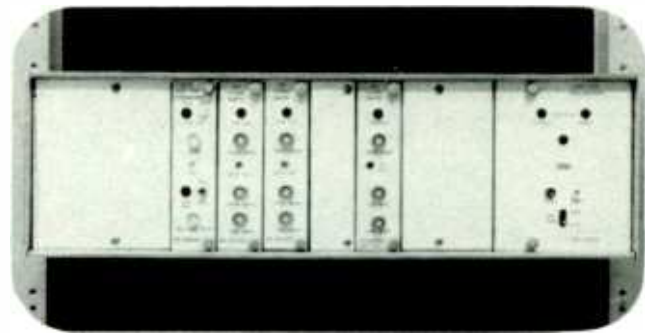

FIGURE 1. FV40 Transmit Equipment Shelf equipped with (left to right): blank covering three unoccupied spaces, Video/Subcarrier Combiner (one space), two FM Channel Transmitter units (one space each), blank covering one unoccupied space, one AM Channel Transmitter unit (one space), blank covering two unoccupied spaces, and a DC -48/-21V Converter unit (three spaces).

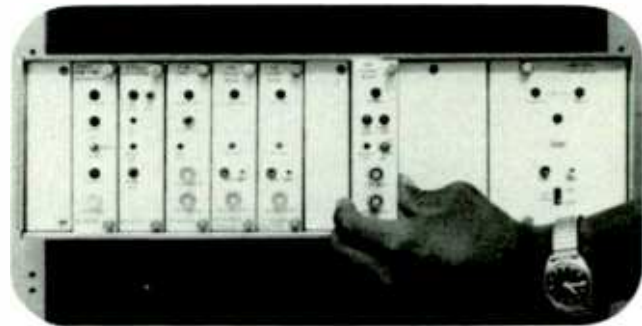
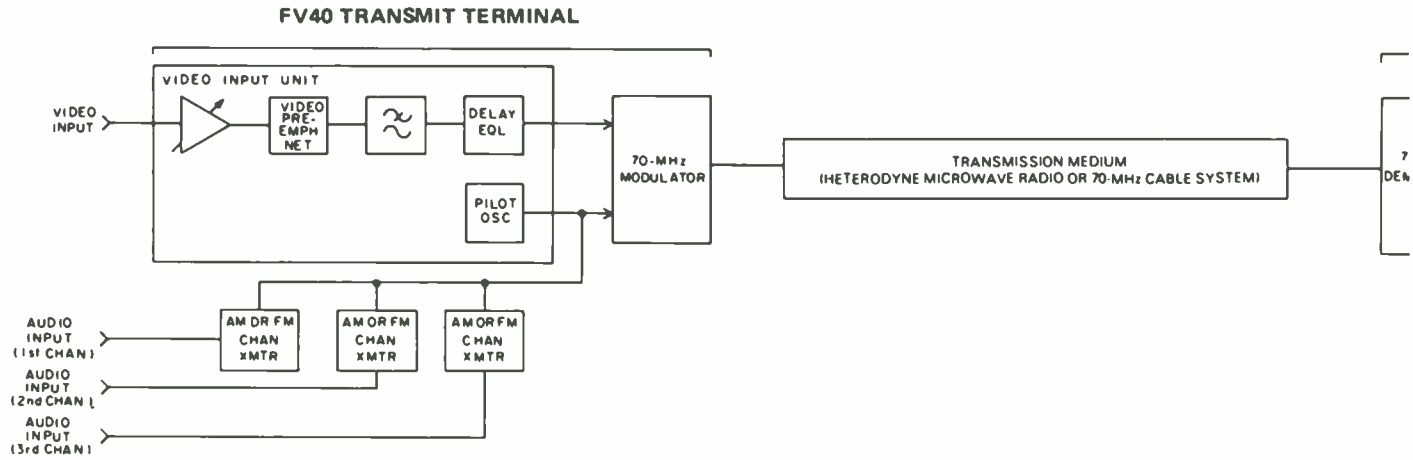

FIGURE 2. FV40 Receive Equipment Shelf equipped with (left to right): blank covering one unoccupied space, Video/Subcarrier Separator (one space), System Monitor for pilot and noise (one space), Clamper Amplifier (one space), two FM Channel Receiver units (one space each), blank covering one unoccupied space, one AM Channel Receiver unit (one space), blank covering two unoccupied spaces, and a DC -48/-21V Converter unit (three spaces).

*optional or selectable function

A. USING IF HETERODYNE RADIO OR VHF CABLE SYSTEM



B. USING BASEBAND RADIO OR VIDEO CABLE SYSTEM

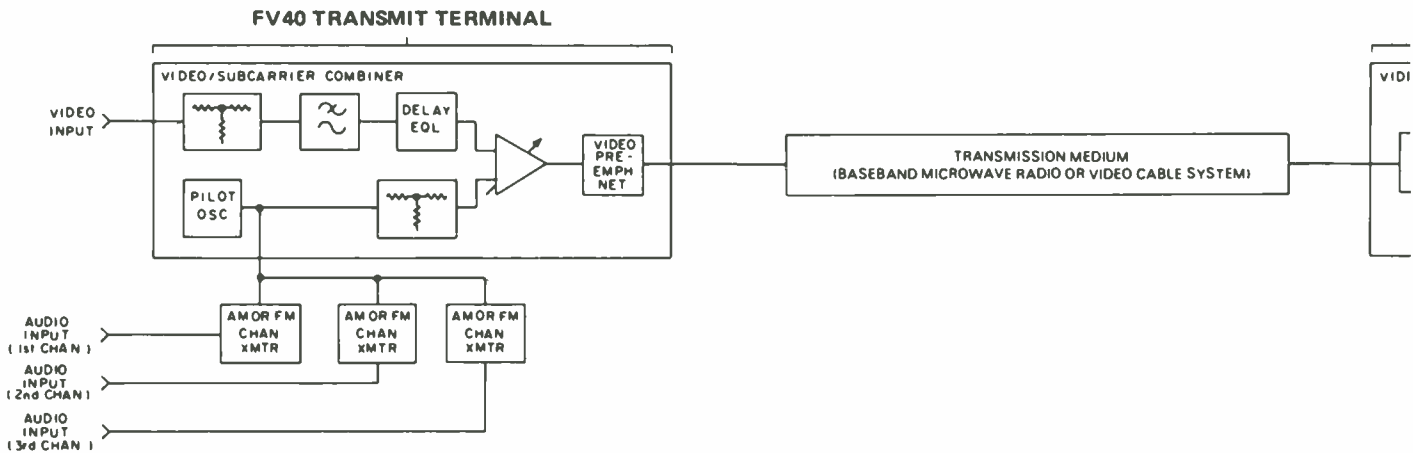

FIGURE 3. Fundamental Point-to-Point FV40

CHARACTERISTICS (Back-to-Back Terminal Pair)

Video Interfaces

Video-Line Input Impedance (Xmt)	75 ohms balanced or unbalanced, or 124 ohms balanced, or high-impedance; 30 dB return loss
Video-Line Input Level	0 dBV, nominal (adjustable -6 to +3 dB)
Video-Line Output Impedance (Rcv)	75 ohms, unbalanced
If Clamper-Amplifier is used	Dual 75-ohm unbalanced or single 124-ohm balanced
Video-Line Output Level	0 dBV

70 MHz IF Interfaces

Input and Output Impedance	75 ohms, unbalanced; 26 dB return loss
Input Level (from radio)	-7 to +1 dBm, -1 dBm nominal
Output Level (to radio)	-7 to +10 dBm (adjustable)

Audio Interfaces

FM Program Channels	
Input and Output Impedance	150 or 600 ohms balanced, or 75 ohms unbalanced
Input and Output Level: Program Audio	-20 to +18 dBm
Wideband Data	-20 to 0 dBm Input, 0 to +15 dBm Output
Voice Channel Multiplex	-40 to 0 dBm Input, -20 to 0 dBm Output (per channel test tone)
AM Orderwire Channels	
Input and Output Impedance	75 ohms unbalanced
Input and Output Level	-30 dBm test tone

Transmitter or Receiver Shelf Office Alarm Output Operating Voltages

One set of Form "C" dry contacts
 -24 Vdc, nominal (-22 to -28 range) or
 -48 Vdc, nominal (-44 to -56 Vdc range) or
 -21 Vdc, regulated
 115/220 Vac (105 to 125 Vac or 200 to 240 Vac ranges), 50-60 Hz

Operating Ambient Temperature Range Mounting

0 to +50°C (+32 to +122°F)
 Shelf requires three vertical rack-mounting spaces, 13.4 cm (5 1/4 inch), on a standard 48.3 cm (19-inch) equipment rack or in a rack cabinet

FV40 RECEIVE TERMINAL

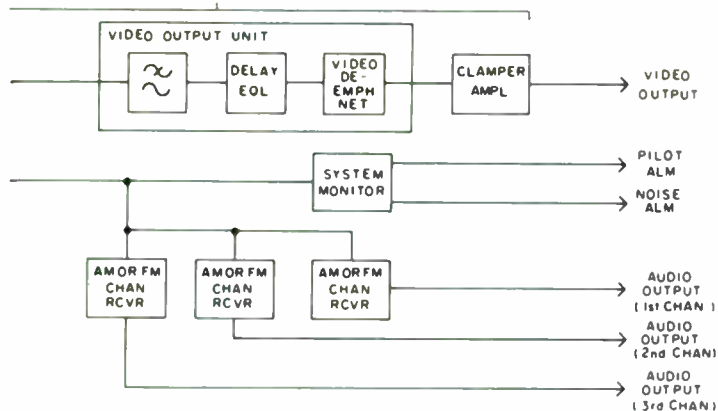

FV40 RECEIVE TERMINAL

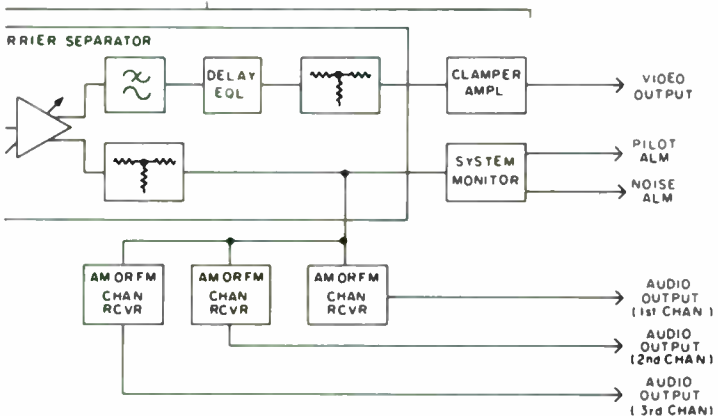

TRANSMISSION PERFORMANCE (Back-to-Back Terminal Pair)

Video	North American 525-Line Service, NTSC	International 625-Line Service, PAL/SECAM
Frequency Response		
10 kHz to 4.2 MHz	0.4 dB p-p	
10 kHz to 5.0 MHz		0.5 dB p-p
Line-Time Distortion	1 IRE p-p	± 0.5%
Field-Time Distortion	2 IRE p-p	± 1%
T-Bar Ringing	4 IRE p-p	
2T Pulse Response		
Pulse to Bar Ratio	± 1 IRE	± 1%
Ringing	2 IRE p-p	2%
12.5T Pulse Response		
Max. Relative Chrominance Level (RCL)	± 1 IRE	
Max. Relative Chrominance Delay (RCD)	± 20 ns	
20T Pulse Response		
Max. Relative Chrominance Level (RCL)		± 1%
Max. Relative Chrominance Delay (RCD)		± 20 ns
Differential Gain 10 to 90% APL	0.5%	0.5%
Differential Phase 10 to 90% APL	0.5°	0.5°
Signal-to-Noise Ratio	70 dB	70 dB
(p-p luminance signal [picture]/rms noise 10 kHz to 5 MHz, EIA/CCIR weighted)		
Signal-to-Hum Ratio (unclamped)	55 dB	55 dB
(p-p luminance signal [picture]/p-p hum dc to 10 kHz)		

FM Audio (Program) Channel

Frequency Response	1 dB p-p, 40 Hz to 15 kHz (Program Service) 1 dB p-p, 40 Hz to 100 kHz (Wide Band Service)
Total Harmonic Distortion (at rated max. modulation)	1%
Signal-to-Noise Ratio (rms test tone at rated max. modulation/rms noise, with 75µs emphasis)	70 dB

AM Orderwire

Frequency Response	1 dB p-p, 300 Hz to 60 kHz
Signal-to-Noise Ratio	43 dB

FM and AM Subcarrier Frequency-Set Options (MHz)

6.2	6.7	7.5	8.2		Std. U.S. FM Subcxrs
6.199	6.7	7.5	8.2		Std. U.S. AM Subcxrs
6.17	6.8	7.67	8.3		Std. Canadian Subcxrs
7.02	7.5	8.065	8.59		CCIR FM Subcxrs
5.14	5.36	5.79	6.2	6.8	Earth Station applications
4.83					Narrow-band Operation (ENG)
5.8	6.4				Bell System Network Transmission

- Note:**
1. Other coordinated FM channel frequency sets are available on order.
 2. 7.02 MHz is lowest usable subcarrier for 625-line systems
 3. A 4.2-MHz video passband must be used with subcarriers below 5.6 MHz

FV2-2.5MP miniature portable microwave “mini-link” for TV transmission

FEATURES

- Lightweight, Compact, Fully Self-Contained
- Frequency Agile in Selected RF Bands
- Built-In Full Quality Program Channel – With Optional Second Audio Channel Available
- AC or Battery Powered – With Multipurpose Charger
- Optional 24V Battery Packs
- IF Interface Option for Transmitter

APPLICATIONS

- For ENG/EJ Remote Pickup
- For Temporary Operation – In Broadcast Services
- For ITV/ETV Temporary Service
- For Security and Surveillance Systems



A miniature portable, frequency-agile 2–2.5-GHz video and sound transmission system replacing existing cable or bulky equipment

SYSTEM DESCRIPTION

FV-MP "mini-link". The Frequency-Agile Radio Systems for the 1700-1915, 1990-2110, or 2450-2690 MHz Bands.

The FV2/2.5MP "mini-link" video/audio transmission system is designed to free the user from restrictive cables or bulky van-mounted equipment for a myriad of applications within the BROADCAST and ETV/ITV services.

With a backpack camera and this lightweight, self-contained microwave transmission package, the broadcaster has the freedom of the cinematographer without the inconvenience or delay of film processing. This system makes possible live coverage from previously inaccessible locations.

In addition, the optional second program channel may be added for multilanguage program audio, dual network feeds, etc.

The FV2/2.5MP is field-tunable in selected portions of the 2/2.5-GHz Television Auxiliary and other bands. This makes it possible to respond to requirements with a flexibility not attainable with fixed-frequency units.

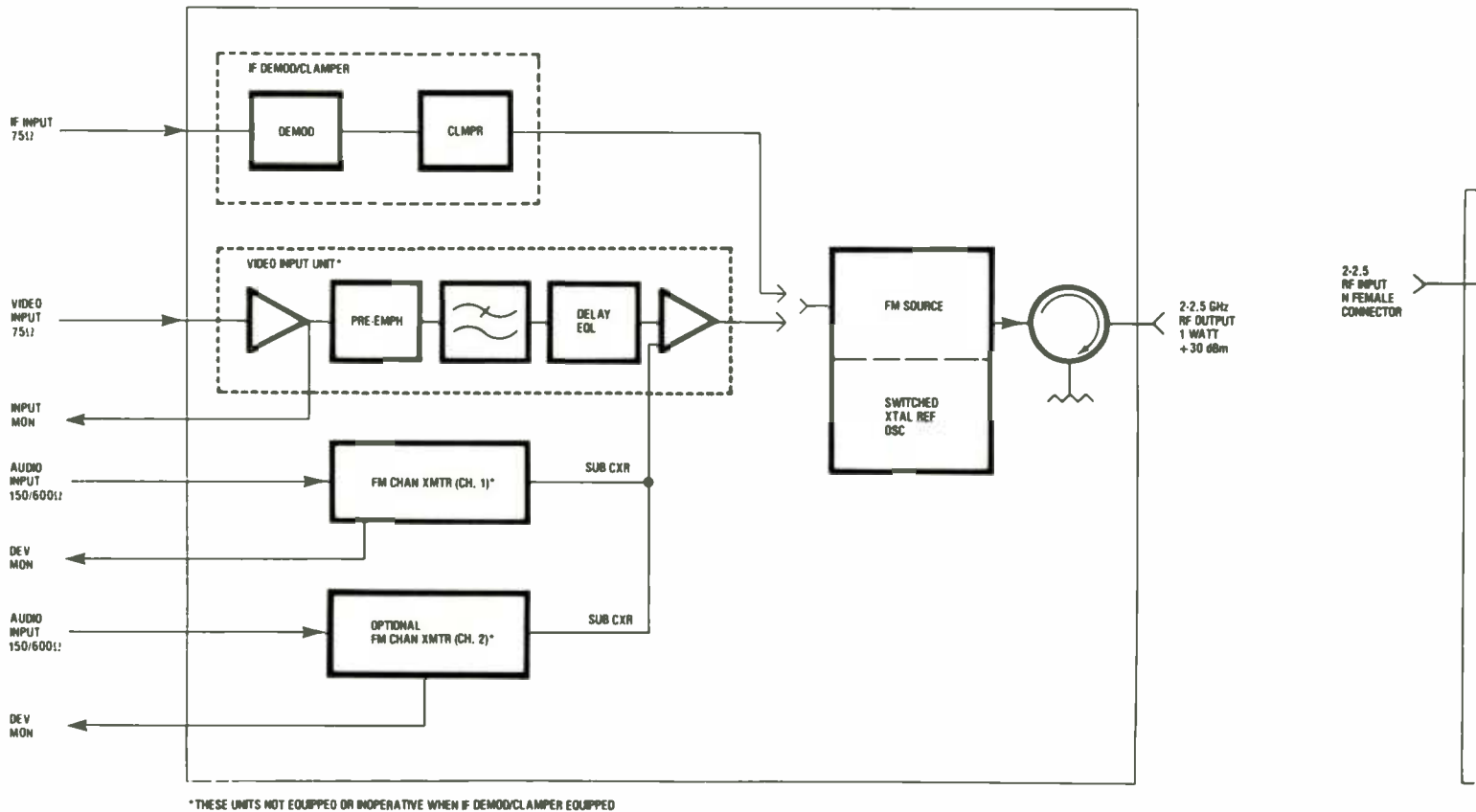

Simplified block diagram FV2/2.5MP transmitter

Transmitter

The FV2/2.5MP transmitter provides for transmission of either a 525-line or 625-line video signal and up to two 15-kHz FM program audio channels. RF channel frequency is phase locked to any of up to 12 predetermined crystal-controlled reference frequencies within the selected RF band.

A low-pass filter and delay equalizer at the video input rejects camera and line noise at the subcarrier frequency. Also provided are +6/ - 4dBV of input video gain and a 0-dBV isolated video monitor.

The transmitter can also be equipped to accept a 70-MHz IF signal by replacing a video input unit with a demodulator clamper unit.

Receiver

The receiver front-end consists of a broadband, low-noise, RF amplifier and a mixer driven by a tunable local oscillator. The oscillator, like that of the transmitter, tunes across the individual band with direct readout at each of the available channels. Again, the frequency is phase locked to a crystal at any of up to 12 predetermined frequencies.

A phase-equalized low-pass filter blocks the audio subcarriers from the video output. The audio subcarrier receivers provide the required headroom at the typical program transmission level.

The radio receiver provides a secondary 70-MHz output for IF interconnection.

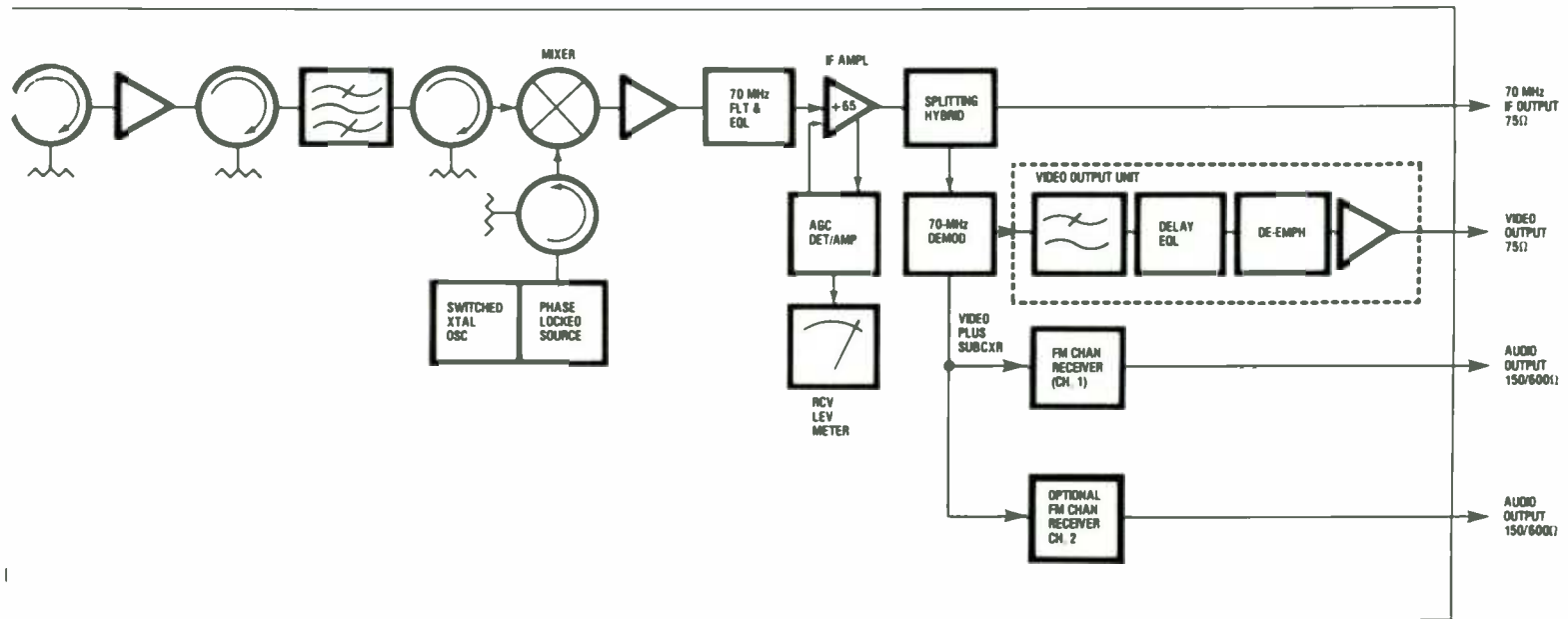

Simplified block diagram FV2/2.5MP receiver

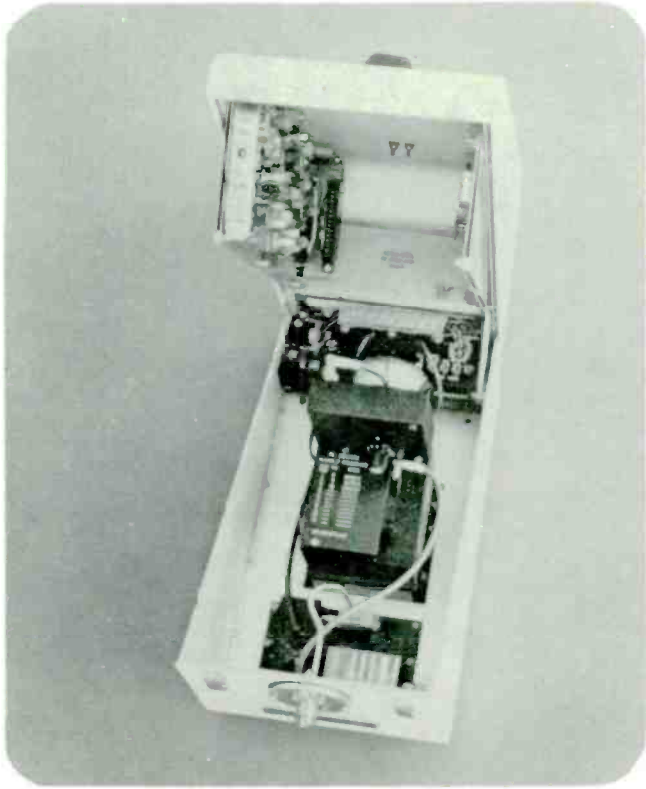

Typical transmitter (2-GHz radio shown)

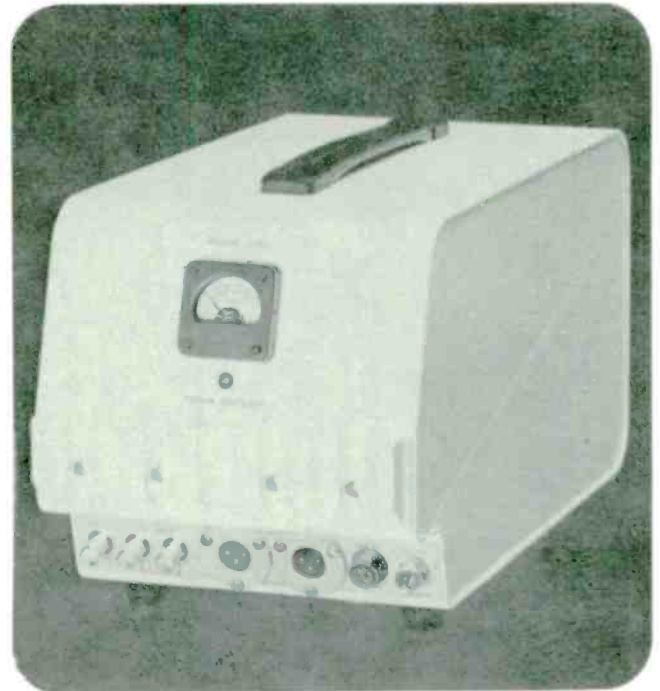
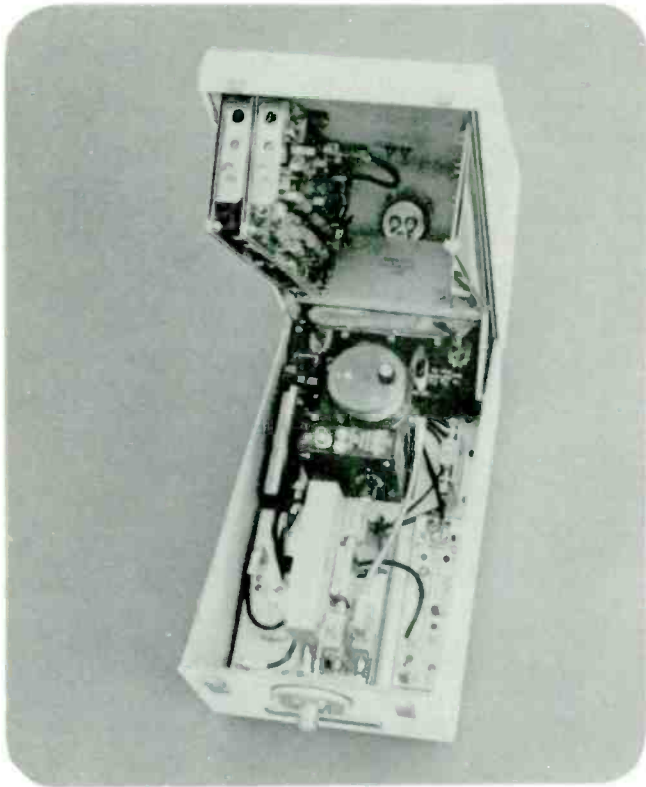

Typical receiver (2-GHz radio shown)

Antenna Options

The FV2/2.5MP terminals may be equipped with 2- or 4-foot long helical antennas available with right hand circular polarization.

The 2-foot helical antennas provide 16 dB of gain for a 40-mile range with a 10-dB fade margin.

With the 4-foot helical antennas, 19 dB of gain is obtained, providing an 80-mile range with a 10-dB fade margin.



Optional 4-foot helical antenna

Power Options

Power for the system is provided by either a multipurpose power supply/battery charger or a rechargeable battery pack. The power supply may be used alone, or mounted atop a battery pack so the battery could instantly take over to prevent program interruption. The supply can also be used in the shop to recharge backup battery packs while the radio is being used in the field.

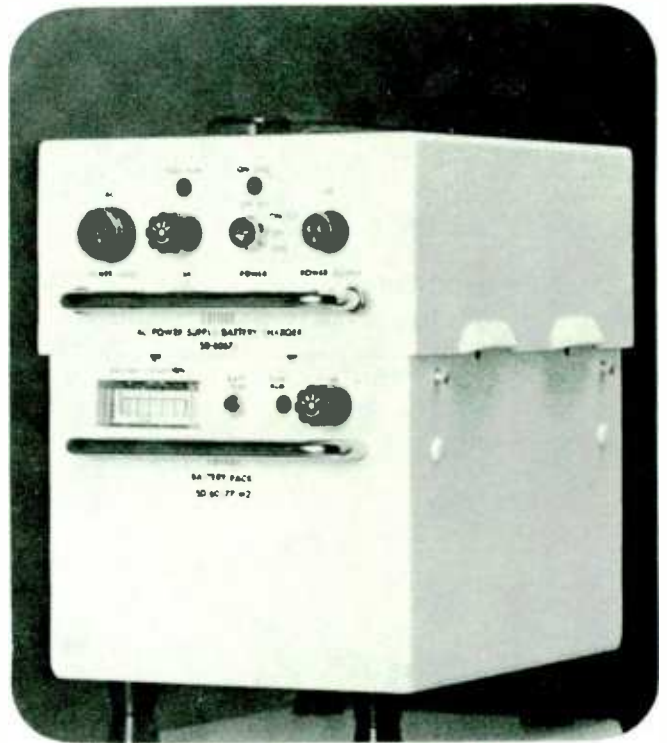

Power options

TYPICAL SPECIFICATIONS**Transmitter**

Tuning Range	1700-1915 MHz 1990-2110 MHz 2450-2690 MHz
Up to twelve channels in each of the above frequency bands are available.	
Frequency Stability	± 0.005% (crystal referenced)
Video Input	1V, p-p, 75 ohms unbalanced
IF Input (70 MHz)	- 4 dBm, 75 ohms unbalanced
Typical Program (Audio)	+8 dBm, (0 dBm for CCIR)
Input	600/150 ohms balanced
Size	375 x 185 x 216 mm (14 3/4 x 7 1/4 x 8 1/2 in)
Weight	6.3 kg (14.0 lbs)

Receiver

Frequency Stability	± 0.005% (crystal referenced)
Video Output	1V, p-p, 75 ohms unbalanced
IF Output	- 4 dBm, 75 ohms unbalanced
Typical Program (Audio)	+8 dBm (0 dBm for CCIR)
Output	600/150 ohm balanced
Size	375 x 185 x 216 mm (14 3/4 x 7 1/4 x 8 1/2 in)
Weight	7.7 kg (17.0 lbs)

General

Powering	115/230 Vac or battery pack
Power Requirements (XMTR or RCVR)	36 watts at - 24 Vdc (approx.)
Operating Ambient Temperature Range	- 30° +50° C (- 22° to +122°F)
Maximum Relative Humidity	95% at +40° C

REFERENCE INFORMATION

BL-60618-M3, BL-60619-M2, Block and Level Drawings for FV2/2.5MP-02 Transmitter and Receiver, respectively.
SD-60364, Accessories Drawing for FV () MP Radios.

Transmission Performance

(For One-Hop, Single-Link Radio System at - 40 dBm Received Signal Level)

Video	North American 625-Line, NTSC Service	International 625-Line, PAL/SECAM Service
	Frequency Response 10 Hz to 4.2 MHz 10 Hz to 5.0 MHz	0.4 dB p-p -
Line Time Distortion	1 IRE p-p	± 0.5%
Field Time Distortion	2 IRE p-p	± 1%
T-Bar Ringing	4 IRE p-p	-
2T Pulse Response: Pulse to Bar Ratio Ringing	± 1 IRE 2 IRE p-p	± 1% 2%
12.5T Pulse Response: Max. Relative Chrominance Level (RCL) Max. Relative Chrominance Delay (RCD)	± 1 IRE ± 20 ns	- -
20T Pulse Response: Max. Relative Chrominance Level (RCL) Max. Relative Chrominance Delay (RCD)	- -	± 1% ± 20 ns
Differential Gain at 10 to 90% APL	1%	1%
Differential Phase at 10 to 90% APL	0.5°	0.5°
Signal-to-Noise Ratio (p-p luminance signal [picture] /rms noise 10 kHz to 5 MHz, EIA/CCIR weighted)	70 dB	70 dB
Signal-to-Hum Ratio (p-p luminance signal [picture] /p-p hum dc to 10 kHz)	50 dB	50 dB

Audio

FM Audio (Program) Channels:	
Frequency Response	1 dB p-p, 40 Hz to 15 kHz
Total Harmonic Distortion (at rated maximum modulation)	1% at peak input/output
Signal-to-Noise Ratio (at peak input level)	70 dB

Optional Available Accessories

Tripods, Antennas, Power Supply, Battery Pack, Cables, Path Simulator, Preselector Filters, Transit Cases.

FCC Application Reference Filed
1990-2110 MHz Part 74
2450-2500 MHz Part 74

FV-MP miniature portable Microwave “mini-link” for TV transmission

FEATURES

- Lightweight, Compact, Fully Self-Contained
- Frequency Agile in Selected RF Band (7, 8, 11, 12, or 13 GHz)
- Built-In Full Quality Program Channel – With Optional Second Channel Available
- AC or Battery Powered – With Multipurpose Charger
- Optional 24V Battery Packs
- Switchable Antenna Polarization – With Optional Horn or Parabolic Antennas for 1.5 to 26 Mile Range
- IF Interface Option for Transmitter

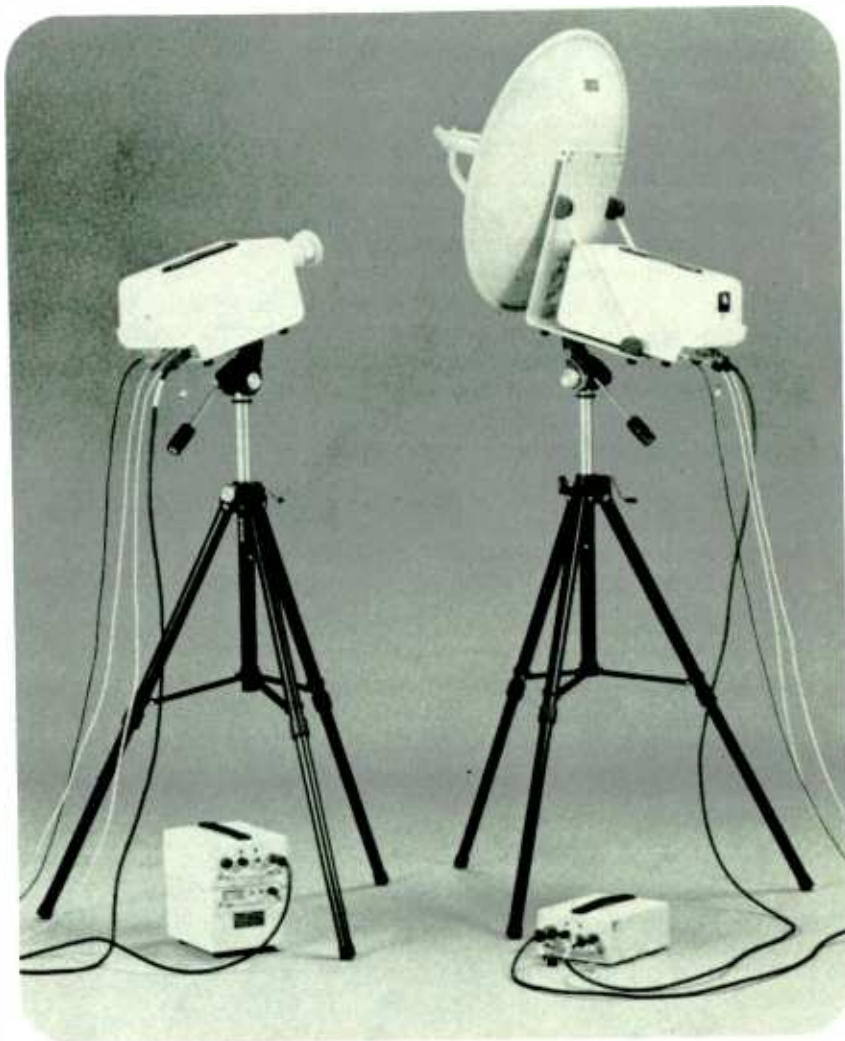

A miniature-portable, frequency-agile video and sound transmission system replacing existing cable or bulky equipment

APPLICATIONS

- For ENG/EJ Remote Pickup
- For CARS SHL
- For Emergency Restoration or Temporary Service – In CARS, Broadcast, Business Bands & Common Carrier Services
- For ITV/ETV Temporary Service
- For Security and Surveillance Systems

SYSTEM DESCRIPTION

FV-MP "mini-link". The Frequency-Agile Radio System in the 7, 8, 11, 12, or 13 GHz Band.

The FV-MP "mini-link" video/audio transmission system is designed to free the user from restrictive cable or bulky van-mounted equipment for a myriad of applications within the BROADCAST, CARS, ETV/ITV, BUSINESS and INDUSTRIAL, and COMMON CARRIER services.

With a backpack camera and this lightweight self-contained microwave transmission package, the broadcaster, the educator or the cable operator has the freedom of the cinematographer without the inconvenience or delay of film processing. This system makes possible live coverage from previously inaccessible locations.

In addition, the optional second program channel may be added for multilanguage program audio, order wire, cueing, alarms, or multiplexed voice and data channels.

The FV-MP being field-tunable in selected RF bands (7, 8, 11, 12, or 13 GHz), makes it possible to respond to requirements with a flexibility not attainable with fixed-frequency units.

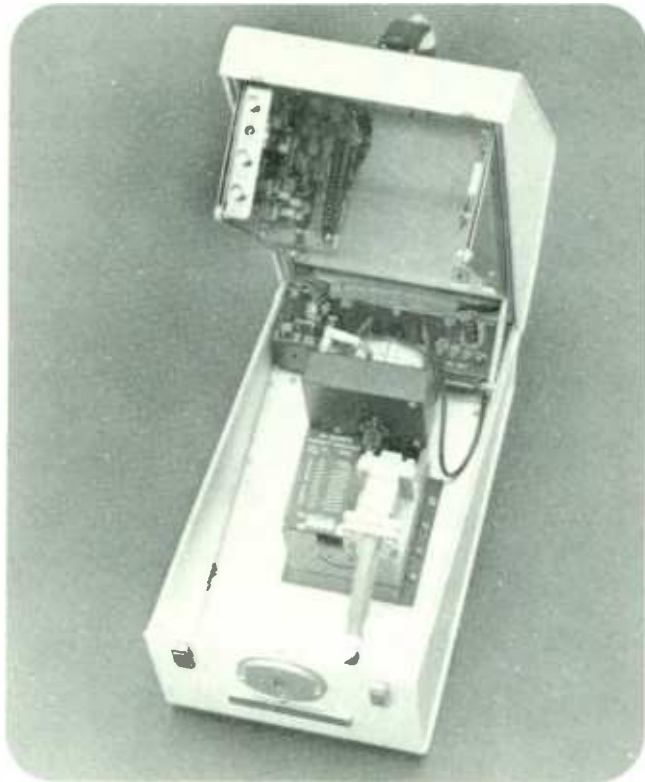

Typical transmitter (12-GHz radio shown)

Transmitter

The FV-MP transmitter provides for transmission of either a 525-line or 625-line video signal and up to two 15-kHz FM program audio channels. RF channel frequency is phase locked to any of 12 predetermined crystal-controlled reference frequencies within the selected RF band.

A low-pass filter and delay equalizer at the video input reject camera and line noise at the subcarrier frequency. Also provided are +6/-4dBV of input video gain and a 0-dBV isolated video monitor.

The transmitter can also be equipped to accept a 70 MHz IF signal by replacing a video input unit with a demodulator clamper unit.

Receiver

The receiver front end consists of a broadband, low-noise, balanced mixer-preamplifier driven by a tunable local oscillator. The oscillator, like that of a transmitter, tunes across the individual band with direct readout at each of the available channels. Again, the frequency is phase locked to a crystal at any of 12 predetermined frequencies.

A phase-equalized low-pass filter blocks the audio subcarrier from the video output. The audio subcarrier receivers provide the required headroom at the typical program transmission level.

The radio receiver provides a secondary 70-MHz output for IF interconnection.

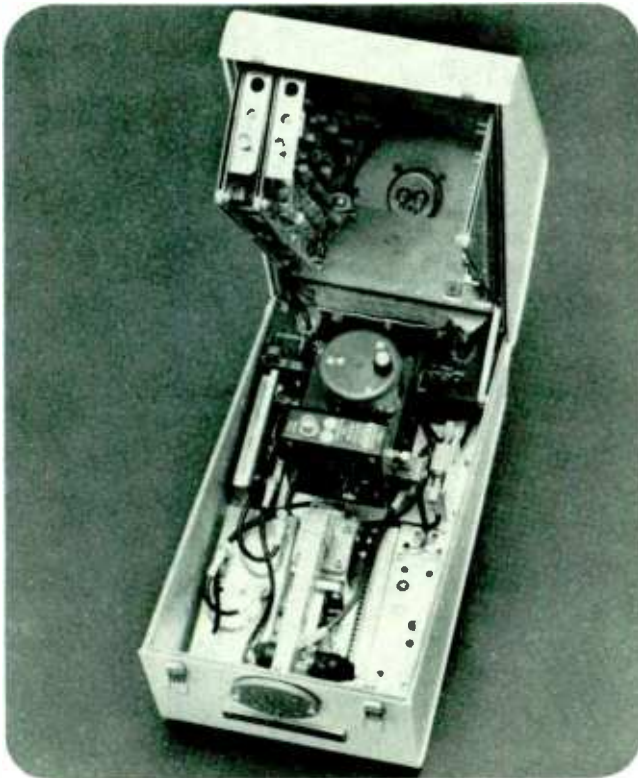

Typical receiver (12-GHz radio shown)



Optional parabolic antenna

Antenna Options

The FV11-13MP terminals may be equipped with either conical (horn) or parabolic antennas, each available with fixed circular or switchable (right-hand or left-hand circular or linear) polarization.

The conical horn antennas, using fixed circular at one end of the path and adjustable polarization at the other, provide up to 18 dB of gain for a 1 ½ mile range with a 10-dB fade margin.

With the two-foot parabolic antennas, again with fixed polarization at one end and adjustable at the other, up to 35.5-dB gain is obtained, providing a 26 mile range with a 20-dB fade margin.

Half-power beam-width is 20° with the conical horns and 2.8° with the parabolic antennas.

FV7MP transmitters and receivers can be equipped with 14" antennas, having a midband gain of 26 dBi and beam width of 8 degrees. Weight is about 6 pounds. They can also be equipped with 2 or 3 foot parabolic antenna having gains of 31 and 34 dBi and adjustable polarization.

Power Options

Power for the system is provided by either a multipurpose power supply/battery charger or a rechargeable battery pack. The power supply may be used alone, or mounted atop a battery pack so the battery could instantly take over to prevent program interruption. The supply can also be used in the shop to recharge backup battery packs while the radio is being used in the field.

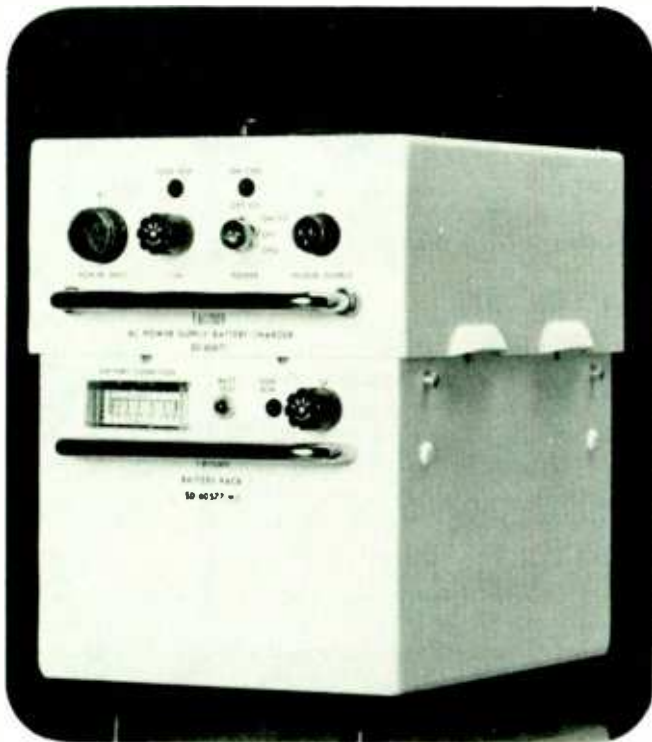

Complete Accessories

Farinon provides all accessories required to operate the FV-MP system, including pan/tilt head tripods, antennas, mounting brackets for parabolic antennas, power supply/recharger units, battery packs, selected interconnecting cables, transit cases and path simulators.

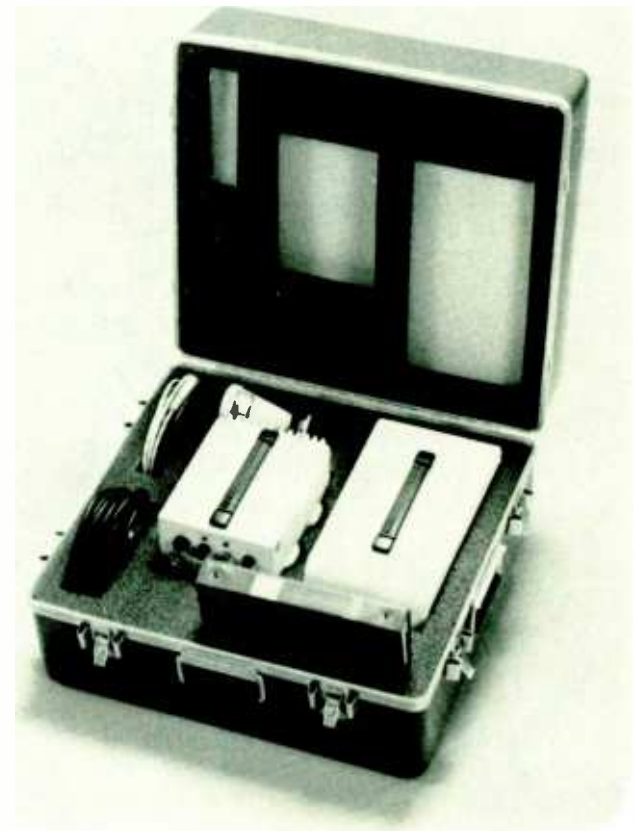

TYPICAL SPECIFICATIONS

Transmitter

SYSTEM DESIGNATOR	FREQ. RANGE MHz	RF PWR OUT dBm (mW) (MINIMUM)
FV7MP	6875-7125	+24 (250) or +30 (1000)
FV8MP	7125-8500	+29 (800)
FV11MP	10550-11700	+18 (63)
FV12MP	11700-12700	+18 (63)
FV13MP	12700-13250	+18 (63)

Up to twelve channels are available in each of the above frequency bands

Frequency Stability	± 0.005% (crystal referenced)
Video Input	1V, p-p, 75 ohms unbalanced
IF Input (70 MHz)	4 dBm, typical, 75 ohms unbalanced
Typical Program (Audio) Input	+8 dBm, (0 dBm for CCIR)
Size	600/150 ohms balanced
Weight	375 x 185 x 216 mm (14 3/4 x 7 1/4 x 8 1/2 in) 6.3 kg (14.0 lbs)

Receiver

SYSTEM DESIGNATOR	DESCRIPTION	NOISE FIG. dB	THRESHOLD (S/N = 37 dB) dBm
FV7 8MP	—	6.0	-83.0
FV11/12/13MP	With Preselect Filter	10.5	-78.5
	Without Preselect Filter	8.5	-80.5

Frequency Stability	± 0.005% (crystal referenced)
Video Output	1V, p-p, 75 ohms unbalanced
IF Output	4 dBm, typical, 75 ohms unbalanced
Typical Program (Audio) Output	+8 dBm (0 dBm for CCIR)
Size	600/150 ohm balanced
Weight	375 x 185 x 216 mm (14 3/4 x 7 1/4 x 8 1/2 in) 7.7 kg (17.0 lbs)

General

Powering	115/230 Vac or battery pack
Power Requirements (XMTR or RCVR)	36 watts at -24 Vdc (approx.)
Operating Ambient Temperature Range	-30° to +50°C (-22° to +122°F)
Maximum Relative Humidity	95% at +40°C
Standard waveguide flanges allow coupling to existing waveguide systems	

REFERENCE INFORMATION

BL-60680 M2, BL-60681-M2, Block & Level Drawings for FV7MP-M2 Transmitter and Receiver, respectively

BL-60566 M2, BL-60565-M2, Block & Level Drawings for FV11-13MP M2 Transmitter and Receiver, respectively

SD-60364, Accessories Drawing for FV () MP Radios

TRANSMISSION PERFORMANCE

(For One-Hop, Single-Link Radio System at -40 dBm Received Signal Level)

Video	North American 525-Line, NTSC Service	International 625-Line, PAL/SECAM Service
Frequency Response		
10 Hz to 4.2 MHz	0.4 dB p-p	—
10 Hz to 5.0 MHz	—	0.5 dB p-p
Line-Time Distortion	1 IRE p-p	± 0.5%
Field-Time Distortion	2 IRE p-p	± 1%
T-Bar Ringing	4 IRE p-p	—
2T Pulse Response:		
Pulse to Bar Ratio	± 1 IRE	± 1%
Ringing	2 IRE p-p	2%
12 5T Pulse Response		
Max. Relative Chrominance Level (RCL)	± 1 IRE	—
Max. Relative Chrominance Delay (RCD)	± 20 ns	—
20T Pulse Response		
Max. Relative Chrominance Level (RCL)	—	± 1%
Max. Relative Chrominance Delay (RCD)	—	± 20 ns
Differential Gain at 10 to 90% APL	1%	1%
Differential Phase at 10 to 90% APL	0.5°	0.5°
Signal-to-Noise Ratio (p-p luminance signal [picture] / rms noise 10 kHz to 5 MHz, EIA/CCIR weighted)	70 dB	70 dB
Signal-to-Hum Ratio (p-p luminance signal [picture] / p-p hum dc to 10 kHz)	50 dB	50 dB

Audio

FM Audio (Program) Channels:	
Frequency Response	1 dB p-p, 40 Hz to 15 kHz
Total Harmonic Distortion (at rated maximum modulation)	1% at peak input/output
Signal-to-Noise Ratio (at peak input level)	70 dB

Optional Available Accessories

Tripods, Antennas, Power Supply, Battery Pack, Cables, Path Simulator, Preselector Filters, Transit Cases.

FCC Type Accepted For:

10.55-10.68 GHz	Part 94	12.2-12.7 GHz	Part 94
10.7-11.7 GHz	Part 21	12.7-12.95 GHz	Part 78
11.7-12.2 GHz	Part 21	13.2-13.25 GHz	Part 21
Application Reference Filed		12.7-13.25 GHz	Part 74

FV-F heterodyne microwave for television transmission

All Solid-State Microwave Terminals and Heterodyne Repeaters
Designed for STL and Intercity Video Transmission



FEATURES

- High-Power Output
- LNA Receiver Front Ends
- Frequency Stability
- Drop/Insert Capabilities
- Equipment/Path Protection
- Low Voltage Operation

Typical terminal arrangement with FV-F
IF Heterodyne Microwave Radio and
FV40 Video Transmission Equipment.

Features

- **Performance** – Meets or exceeds CCIR and Bell System recommendations. Meets medium and long haul requirements of EIA RS-250-B.
- **High-Power Output** – Typically 5 or 20 watts at 2 GHz, 10 watts at 2.5 GHz, 1 watt at 6-8 GHz, or 0.8 watt at 11-13 GHz
- **LNA Receiver Front End** – Low Noise Amplifier (LNA) in the receiver front end provides minimum noise figure and therefore maximum system gain.
- **Frequency Stability** – $\pm 0.005\%$ across each band.
- **Complete Terminals and Repeaters are available with Drop/Insert Capabilities** – Companion FV40 Video Transmission Equipment supplements the radio and provides modem, signal conditioning, program channels, monitoring facilities, protection switching, and many other auxiliary functions. System is a responsive broadband video transmission medium that is suitable for handling the needs of many complex signal forms.
- **Equipment Configurations** – Protected (monitored hot-standby or frequency diversity) and non-protected arrangements.
- **Low Voltage Operation** – Power supplies optionalized to handle dc and ac source voltages.
- **Versatile** – Provides complete coverage of worldwide TV-broadcast video transmission bands.
- **Simplified Spare Replacement** – Many of the active units and circuit modules are common to all frequency bands.
- **Convenient Maintenance** – Mechanical design and size coordinated so that all units and modules are fully accessible for adjustment or replacement.
- **Fully Factory Tested** – Installation is fast and simple.
- **Complete Factory Support** – System Engineering, Field Service, and Repair Service support are provided by experienced telecommunication engineers.

Associated Equipment

Available companion options include:

FV40 Video Transmission Equipment

-24 Vdc, -48 Vdc, 115 Vac, and 220 Vac (50-60 Hz)

Rack or rack cabinet mounting arrangements

Order wire and multipoint bridges

Supervision, Control and Remote Monitoring Subsystems

Protection switching facilities

Antenna Equipment, and branching filters and custom waveguide configurations

Clamper and Distribution Amplifiers, etc.

FV44 Radar Transmission Equipment for Vessel Traffic Systems and Air Traffic Control

System Description

The FV-F family of fixed microwave is a series of integrated IF heterodyne radio transmitters and associated receivers that cover all TV broadcast intercity relay and local studio transmitter link (STL) bands between 1.7 and 13.25 GHz. As individual rack-mounted frames, the transmitters and receivers can be custom-arranged for any desired system configuration. These include transmit or receive-only terminals, with or without protection switching, or bi-directional layouts that include return path facilities for monitor and control reporting functions. Multiple-system, parallel or branching-path radios, of differing frequency bands, can be mounted on the same rack assembly. Many circuit modules of the FV-F radio are common to many or all frequency bands. This results in system economy, as component stockage and service training requirements are reduced.

While the radio has the standard 70-MHz interface with other video and audio transmission system elements, companion FV40 equipment provides the baseband facilities for standard EIA/CCIR video and audio line interconnect. Repeaters can be simply formed by receiver-to-transmitter IF connection, with attendant low signal degradation, or readily equipped with the FV40 equipment for baseband drop and insert functions.

The radio assemblies can be used for new microwave systems, or may be used for route or channel expansion within existing systems. All interfaces are tailored to recognize worldwide standards. Closely-spaced RF channel capability and stable frequency control allow multichannel, parallel-path, high-density RF operation. Automatic carrier resupply ensures continued operation of maintenance and order wire facilities should equipment failure or poor signal conditions develop in preceding system hops.

All receivers and transmitters are fitted with complete fault-alarm detection circuits, and suitable signal monitoring accesses and circuit test points. A true off-the-air monitor pick-off and demodulator is provided in the transmitter output stage for continuous check of transmitted signal quality and continuity pilot. Protection arrangements may be made by a monitored hot-standby system, frequency or space-diversity configurations, or by combinations of these methods.

Depending on operating band, many active circuit elements of the transmitter and receiver make use of state-of-the-art designs and components. Some of these are Gunn-diode injection-locked amplifiers, phase-locked sources, and thin-film microstrip power amplifiers. RF filter designs result from latest computer-generated techniques.

Receivers are equipped with an IF signal splitter; one IF output can be dropped and demodulated locally, and the other fed to line or repeater facilities.

Typical FV-F Radio System Performance

Values shown are those expected from a Seven-Hop Intercity Relay System (Transmit and Receive Terminals, and Six Repeaters). FV40 Video Transmission Equipment is used at the terminals for modem, signal conditioning and subcarrier facilities. For these values, Received Signal Level for each hop is -30 dBm:

	North American 525-Line Service, NTSC	International 625-Line Service, PAL/SECAM
Video:		
Frequency Response		
10 kHz to 4.2 MHz	0.6 dB p-p	-----
10 kHz to 5.0 MHz	-----	0.7 dB p-p
Line-Time Distortion	1 IRE p-p	±0.5%
Field-Time Distortion	2 IRE p-p	±1%
T-Bar Ringing	4 IRE p-p	-----
2T Pulse Response		
Pulse to Bar Ratio	± 1 IRE	± 1%
Ringing	2 IRE p-p	2%
12.5T Pulse Response		
Max. Relative Chrominance Level (RCL)	± 2 IRE	-----
Max. Relative Chrominance Delay (RCD)	± 20 ns	-----
20T Pulse Response		
Max. Relative Chrominance Level (RCL)	-----	± 2%
Max. Relative Chrominance Delay (RCD)	-----	± 20 ns
Differential Gain at 10 to 90% APL	3%	3%
Differential Phase at 10 to 90% APL	1°	1°
Signal-to-Noise Ratio	67 dB	67 dB
(p-p luminance signal [picture] /rms noise 10 kHz to 5 MHz, EIA / CCIR weighted)		
Signal-to-Hum Ratio (unclamped)	55 dB	55 dB
(p-p luminance signal [picture] /p-p hum dc to 10 kHz)		
FM Audio (program) Channel:		
Frequency Response	1 dB p-p, 40 Hz to 15 kHz	
Total Harmonic Distortion (at rated max. modulation)	1%	
Signal-to-Noise Ratio (rms test tone at rated max. modulation/rms noise) (with 50 μs or 75 μs emphasis)	70 dB	
AM Audio Transmission Channel:		
Frequency Response	1 dB p-p, 300 Hz to 60 kHz	
Signal-to-Noise Ratio	43 dBrc0	



Typical FV8F protected IF repeaters

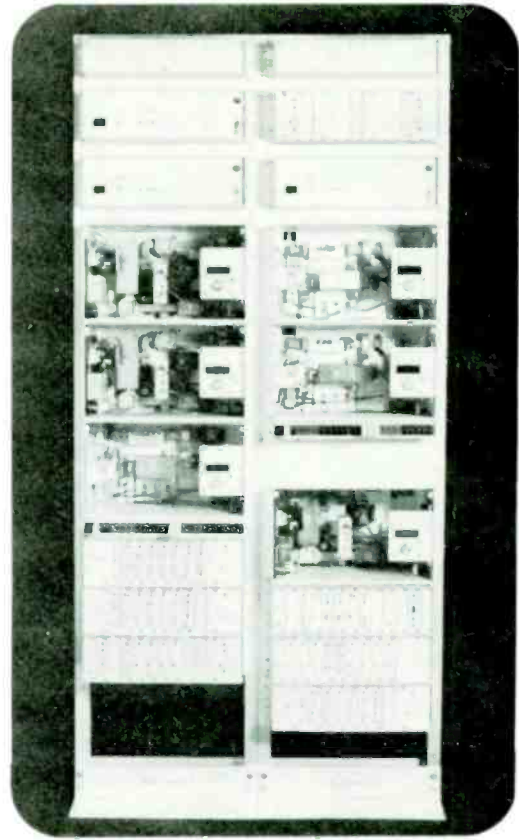

FV13F / FV40 terminal arranged for a one-way, monitored hot standby, studio-transmitter link (STL) and a one-way, non-protected, transmitter-studio link (TSL) with radio covers removed.

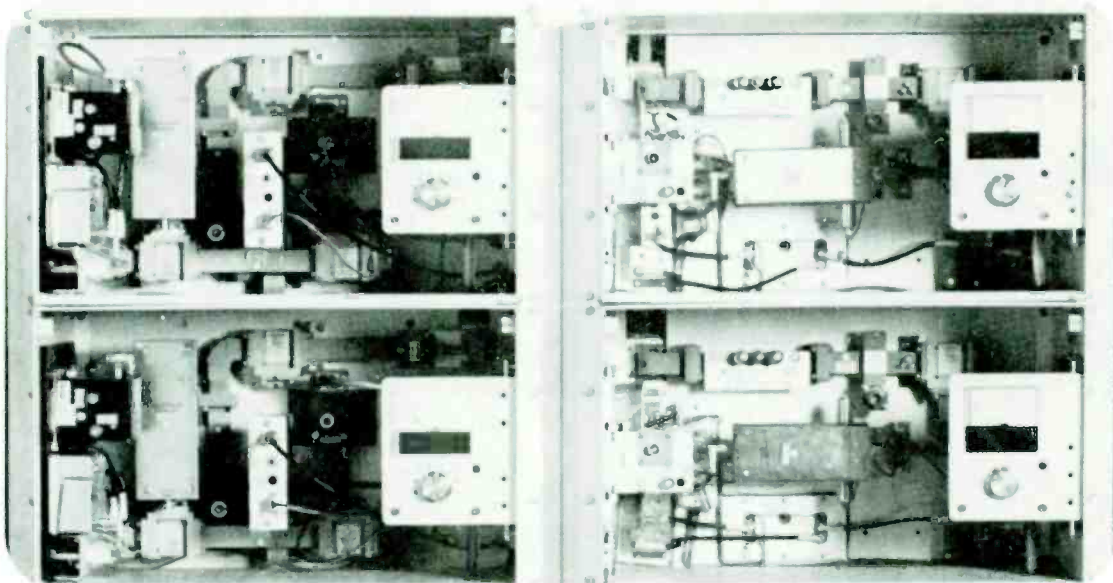

Interior view of FV13F transmitters (left) and receivers (right)

TECHNICAL SPECIFICATIONS**Operating Bands (GHz):**

FV2F	1.990-2.110
	1.700-1.850
	1.850-1.990
	1.700-2.100
FV2.5F	1.900-2.300
	2.300-2.500
	2.500-2.700
FV6/7F	5.925-6.425
	6.425-7.125
	6.875-7.125
FV8F	7.100-7.800
	7.700-8.500
FV11/13F	10.7-11.7
	12.2-12.7
	12.7-13.25

Typical Transmitter Characteristics:**Power Output @ Output Circulator**

FV2F	5 watts (+37 dBm) or
	20 watts (+43 dBm)
FV2.5F	10 watts (+40.0 dBm)
FV6-8F	1 watt (+30 dBm)
FV11-13F	0.8 watt (+29 dBm)

Typical Receiver Characteristics:**Noise Figure @ Input Circulator with LNA* without LNA**

FV2F	4.5 dB	---
FV2.5F	5.5 dB	---
FV6-7F	5.0 dB	8.5 dB
FV8F	5.5 dB	---
FV11-13F	---	10.0 dB

Intermediate Frequency (IF) 70 MHz

* LNA is not presently available in all frequency bands.
Contact your Farinon representative for details

REFERENCE INFORMATION

BL-60655 & 60471	Block & Level, FV2F Receiver and Transmitter
BL-60801 & 60802	Block & Level FV2.5F Receiver and Transmitter
BL-60666 & 60600	Block & Level, FV6/7F Receivers and Transmitters
BL-60812	Block & Level, FV6/7 Receiver
BL-60657 & 60466	Block & Level FV8F Receiver and Transmitter
BL-60667 & 60623	Block & Level, FV11/13F Receivers and Transmitters
BL-60359	Block & Level, FV44 Radar Data Video Transmission Equipment
BL-60789	Block & Level, FV40 Protected Radio System
BL-60755	Block & Level, FV44 Protected Radio Systems -- Vessel Traffic System
Data Sheet 7430	FV40 Video Transmission Equipment
Data Sheet 7621	FV-F/FV44 Video Transmission Equipment for Radar Data Service

MECHANICAL CHARACTERISTICS**(Transmitter or Receiver)**

Vertical	267 mm (10 1/2 in.) 6 rack mounting spaces
Horizontal	483 mm (19 in.)
Depth	Extends forward from front mounting surface 127 mm (5 in.) Extends to rear from front mounting surface 267 mm (10 1/2 in.)

Front access only is required for normal operations and maintenance.

Power Sources:

115 or 220 Vac, 50-60 Hz, or -24 or -48 Vdc

Ambient Temperature Range:

-30° to +50°C (-22° to +122°F) operating range

0° to +40°C (+32° to +104°F) specified performance range

FV2/2.5MF Miniature Microwave Radio Transmitters for ENG/EJ Applications

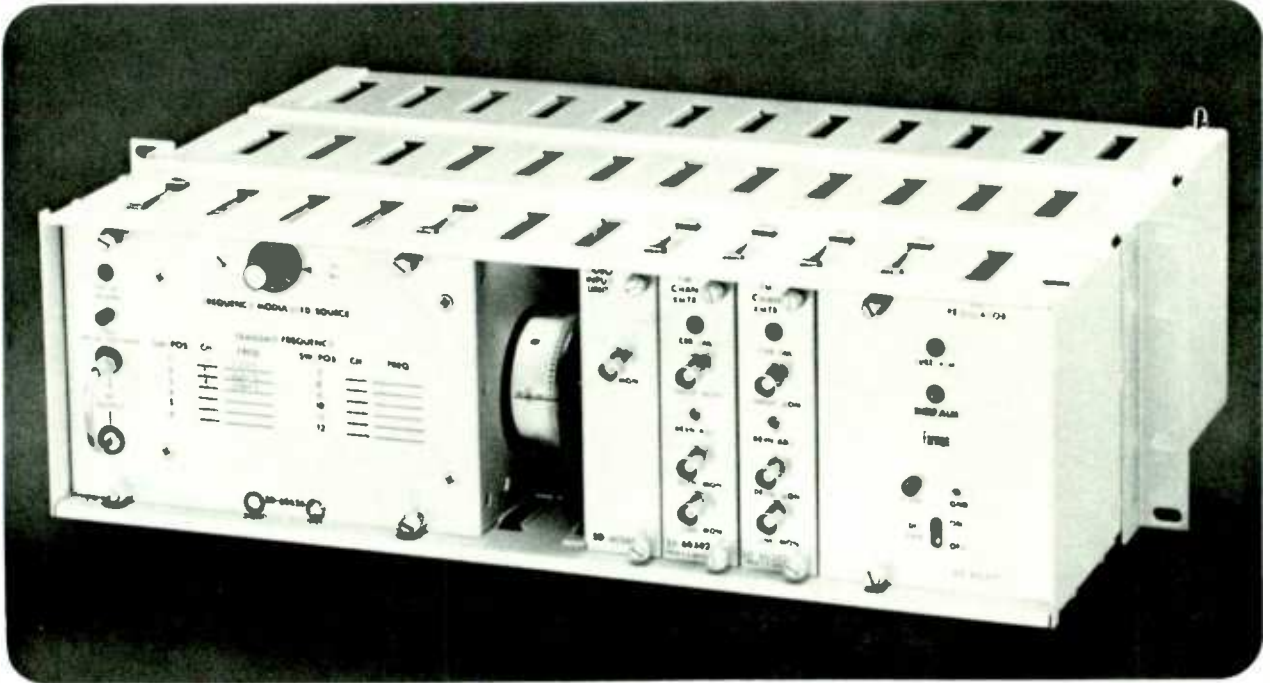

Shown is the compact, lightweight, frequency-agile 2/2.5-GHz video and sound transmitter for ENG/EJ applications including helicopters, mobile broadcast vans and repeater stations.

FEATURES

- FREQUENCY AGILITY – MULTICHANNEL
- 1 WATT RF OUTPUT
- +28, -24, -48 Vdc OR 115/220 Vac OPERATION. USES AIRCRAFT OR VEHICULAR POWER SOURCES.
- OPTIONALLY UP TO TWO (AUDIO) PROGRAM CHANNELS
- 525-LINE NTSC OR 625-LINE PAL/SECAM SERVICE
- MINIMUM OPERATING CONTROLS
- USED WITH FARINON FV-SERIES PORTABLE, MINI-LINK, FIXED, OR FV()CR RECEIVERS
- ALL MODULES PLUG IN. EASY TO MAINTAIN

DESCRIPTION

The FV2/2.5MF Microwave Radio transmitter is designed to provide a high degree of transmission flexibility for airborne (helicopter) ENG/EJ operation or newscast vehicular remote or relay services. RF channel frequency is phase locked to any of 12 preestablished crystal reference frequencies within the following ranges: 1990–2110 or 2450–2690 MHz. A phase-equalized low-pass filter in the video input path rejects camera and line noise at the optional audio subcarrier frequencies.

Various combinations of audio subcarrier frequencies are available to the transmitter. As the transmitter housing will accept two FM program channel transmitter units, just the change of the audio input line feed will shift the program material from one subcarrier frequency to another. If split-channel operation is desirable at 2 GHz, the 4.2 MHz video low-pass filter, designed with the 4.83-MHz audio subcarrier, provides the required narrow transmitter bandwidth.

The basic radio transmitter is completely self contained including power supply and, when equipped, one or two FM program channels. The modularized housing (shelf) occupies three vertical rack mounting spaces in a standard 483-mm (19-in.) equipment rack.

The FV2/2.5MF Transmitter is designed to interface with a wide number of receivers including the FV2/2.5MP "mini-link" receiver, the FV2F fixed receiver or the FV2/2.5CR receiver.

SPECIFICATIONS

FV2/2.5MF Transmitter

Tuning Range (subbands) (Up to 12 discrete frequencies, in any one subband, may be selected by switched crystal oscillator)	1990–2110 MHz 2450–2690 MHz
RF Power Output	1 watt (+30 dBm)
Input Power Requirement (ac or dc)	50 W (approx.)

General

Frequency Stability	±0.005% (crystal reference)
Weight (approx.)	7.8 kg (17.2 lbs.)
Audio Input Impedance	150 or 600 ohms, bal.
Powering Source	+28, -24, -48 Vdc or 115/220 Vac

Reference Information

BL-60707 – Block and Level Drawing
FV2/2.5MF Transmitter
FV2/2.5MF DI – Descriptive Information
Data Sheet 7634 – 60515 Power Amplifier



FV 2/2.5 MF Transmitter with external power amplifier (60515) occupies only 5 mounting spaces.

FV2CR ENG Microwave Radio Receiver

The "Central Receiver" for ENG Applications

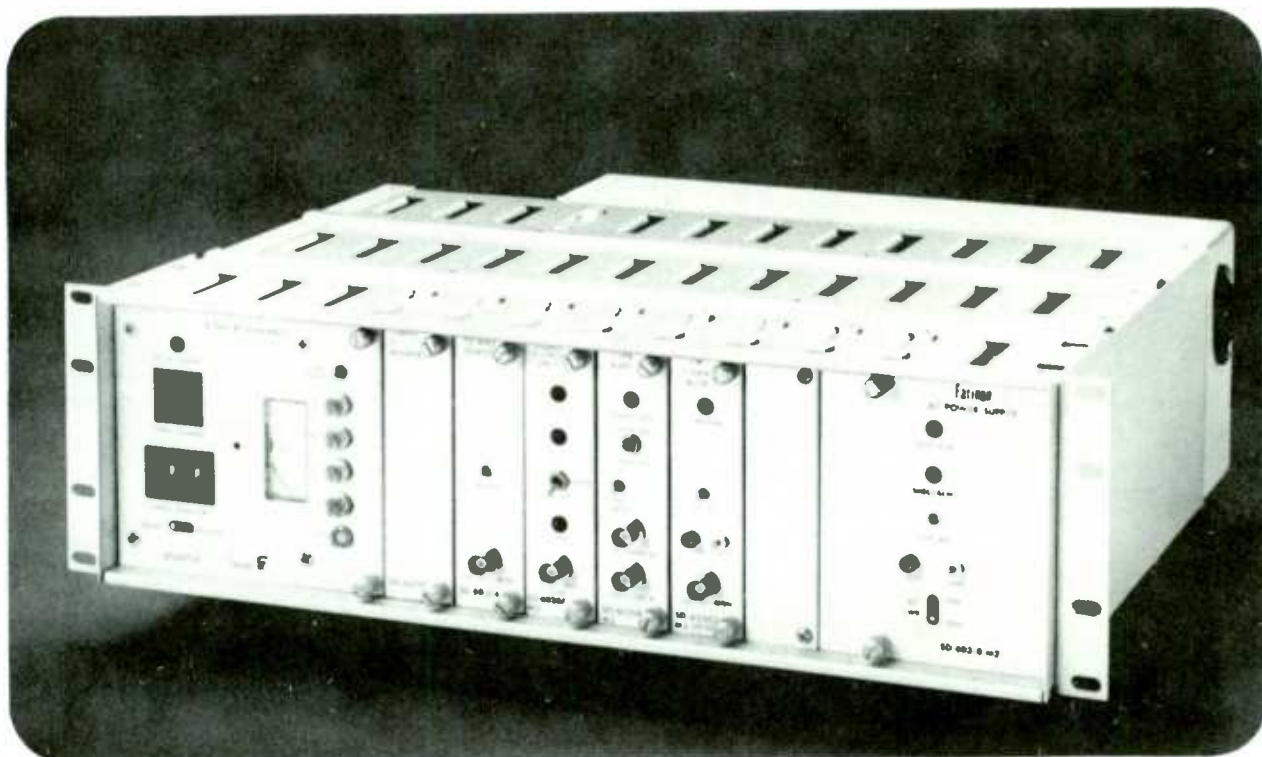

The FV2CR is a frequency-agile, low-noise, narrowband, 2-GHz receiver designed specifically for video and audio pick up from "at-the-scene" Electronic Newsgathering (ENG) crews.

FEATURES

- 21 SYNTHESIZED CHANNELS, INSTANTANEOUS PHASE LOCK – locally or remotely selectable. Covers the range from 1990 to 2110 MHz.
- 3-dB NOISE FIGURE – low-noise amplifier integral to the receiver.
- NARROWBAND IF SAW FILTER – for "state-of-the-art" split-channel operation.
- 82-dB DYNAMIC INPUT-SIGNAL LEVEL RANGE – crews operate anywhere from maximum range to within the shadow of the receiver's antenna.
- FULLY ALARMED – with dry contacts for remote indication.
- AUXILIARY IF OUTPUT – for heterodyne interconnection.
- RFI SHIELDED – for operation in an interfering environment.

FOCUS ON RECEIVING QUALITY FOR ENG CENTRAL PICKUP

SYSTEM DESCRIPTION

The FV2CR ENG Receiver has been designed to provide a high degree of reception flexibility for ENG-type applications. RF channel frequency is instantaneously phase locked to any of 21 synthesized, discrete channels within the 1990 to 2110-MHz range. The channels are locally or remotely selectable and, in the remote mode, the selected channel number will be displayed on the receiver as well as at the remote location.

The Low-Noise Amplifier (LNA) can be remotely located at the antenna, locally at the receiver, or at both locations depending upon system requirements. The LNA is equipped with a bypass (used in the event of strong signal levels) and a combine filter protecting against out-of-band signals. Overvoltage transient suppressors built into the dc power and control lines provide lightning protection to the remotely-located LNA and the receiver. The superb image rejection capability of the receiver is provided through a state-of-the-art mixer design.

A Narrowband IF SAW Filter provides maximum adjacent channel selectivity with minimum transmission degradation. Better than 82 dB of dynamic range is available. For example: using a 23-dB gain, steerable

receiving antenna, a 22-dB gain, dual helix transmitting antenna, and the maximum permitted transmitter power, an operational range extending from 1/8 mile to 300 miles can be realized. A 20-dB, minimum, fade margin will be maintained over the entire range.

An extended range acquisition feature is incorporated in the receiver. Summing of the AGC and Noise Detector voltages provides an extended AGC meter reading. This allows viewing of low RF signal levels that would be unreadable under a standard AGC meter configuration.

In the FV2CR receiver, key circuit functions are alarmed and furnished with dry contacts for remote indication.

A separate 70-MHz IF signal output is provided for heterodyne interconnection to a TSL link.

The receiver normally will operate with 115/230 Vac input voltage. DC input voltage options are available.

The FV2CR ENG Receiver is another major component of the "Total Concept" ENG System offering.

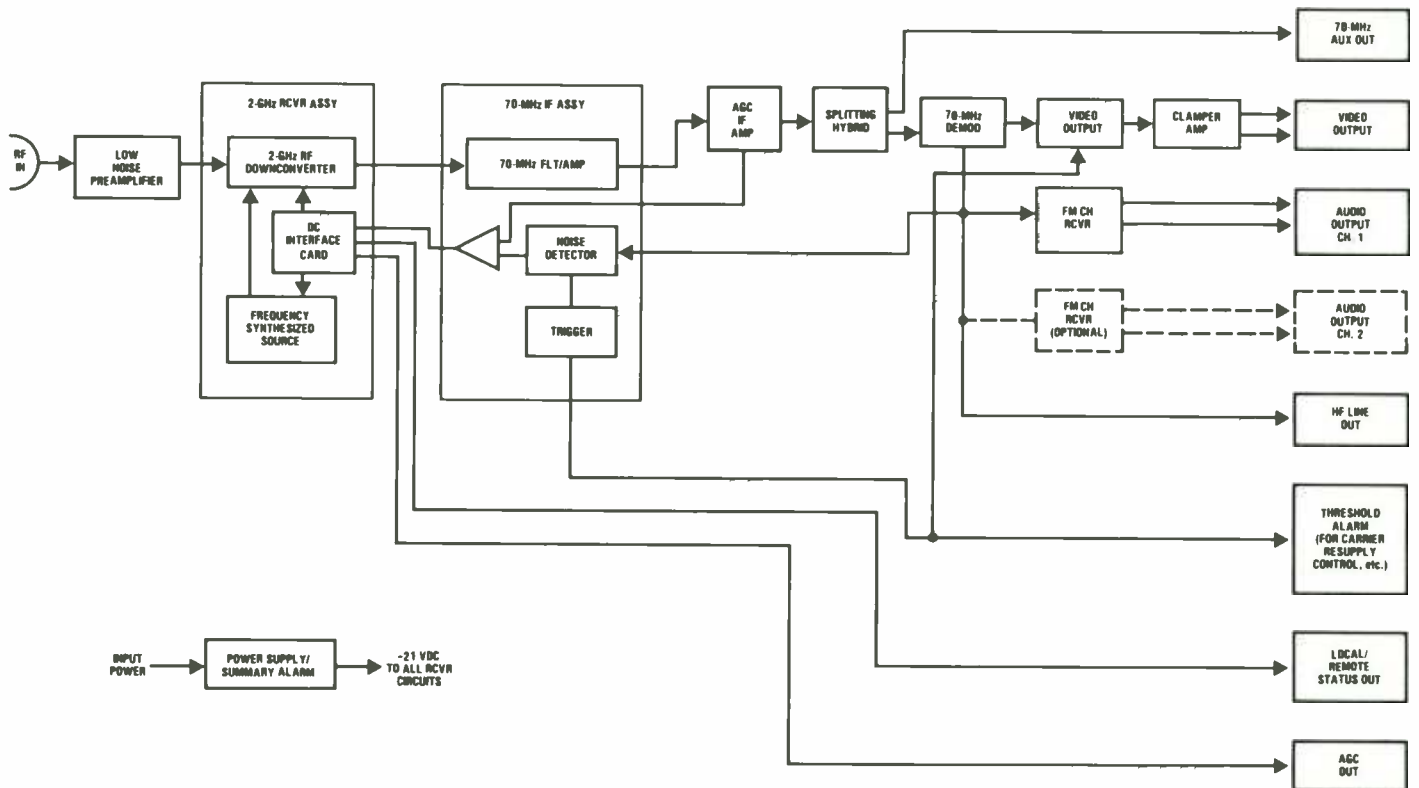

Simplified Block Diagram of Typical FV2CR Receiver Circuitry

TYPICAL SPECIFICATIONS**General**

Tuning Band	1990 to 2110 MHz
Local Oscillator	Synthesized, 21 discrete frequencies
Frequency Stability	± 0.005%
Receiver System Noise Figure (Low-Noise Amplifier equipped in receiver front end.)	3.0 dB
Selectivity at ± 8.5 MHz (10-MHz IF Filter)	At least - 48 dB

RF Input

Dynamic Range	- 5 dBm to threshold (at least 82 dB) plus 10 dB additional range for signal acquisition
Connector	Precision N type
Impedance	50 ohms, unbalanced
Return Loss	20 dB

IF

Frequency	70 MHz
Bandwidth (1-dB points)	10-MHz SAW filter (standard) 16-MHz L-C filter (optional)
Auxiliary Output Level	- 1 dBm
Impedance	75 ohms, unbalanced

Temperature

Meets all specifications	+ 10° to + 40°C (+ 50° to + 104°F)
Operational	- 10° to + 50°C (+ 14° to + 122°F)

Size

Uses three vertical rack mounting spaces in a 19-inch equipment rack (L x W x H)	381 x 483 x 133 mm (15 x 19 x 5- 1/4 in.)
--	--

Weight (approximate)

15.9 kg (35 lbs)

Operating Voltage Options

AC (50/60 Hz)	115 (105-125) Vac 220 (200-240) Vac
DC	- 24 (- 22 to - 28) Vdc + 28 (+ 22 to + 32) Vdc

Remote Controls

21-Channel Selection	
LNA Bypass	

Alarms

Summary Alarm	Form "C" Dry Contacts
LO Phase Lock	
Video Presence (Optional)	
Clamper Fail	
Subcarrier Fail	
Local/Remote Status	
Receiver Threshold Alarm	

Transmission Performance:

(Receiver equipped with 10-MHz IF filter and receiving from a coordinating FV2MP or MF transmitter.)

North American 525-Line, NTSC Service**Video**

Output Level	1V p-p
Impedance	75 ohms, unbalanced
Frequency Response	0.6 dB p-p
10 Hz to 4.2 MHz	
Line Time Distortion	1 IRE p-p
Field Time Distortion	2 IRE p-p
T-Bar Ringing	7 IRE p-p
2T Pulse	
Pulse to Bar Ratio	± 2 IRE
Ringing	4 IRE p-p
12.5T Pulse	
RCL	± 2 IRE
RCD	± 40 ns
Differential Gain	
10 to 90% APL	5%
Differential Phase	
10 to 90% APL	3.0°
Signal-to-Noise Ratio (p-p luminance/rms Noise)	70 dB
10 kHz to 5 MHz	
EIA/CCIR weighted	
RSL = - 40 dBm	
Signal to Hum Ratio (p-p luminance/p-p Hum)	53 dB
DC to 10 kHz	

FM Audio (Program) Channels

Output Level	+ 8 dBm (single-frequency test tone)
Impedance	150/600 ohms, balanced
Deviation	75 kHz, peak (4.83 MHz subcarrier only) 200 kHz, peak (All other subcarriers)
Frequency Response (40 Hz to 15 kHz)	1 dB p-p
Total Harmonic Distortion	1% at peak output level
Signal-to-Noise Ratio Flat (non-weighted)	66 dB
Subcarrier Frequency	4.83 MHz (standard) Other subcarriers available when FV2CR is equipped with the 16-MHz IF filter.

REFERENCE INFORMATION

BL-60772 - Block and Level Diagram, FV()CR Receiver

FV2.5CR ENG Microwave Radio Receiver

The "Central Receiver" for ENG Applications

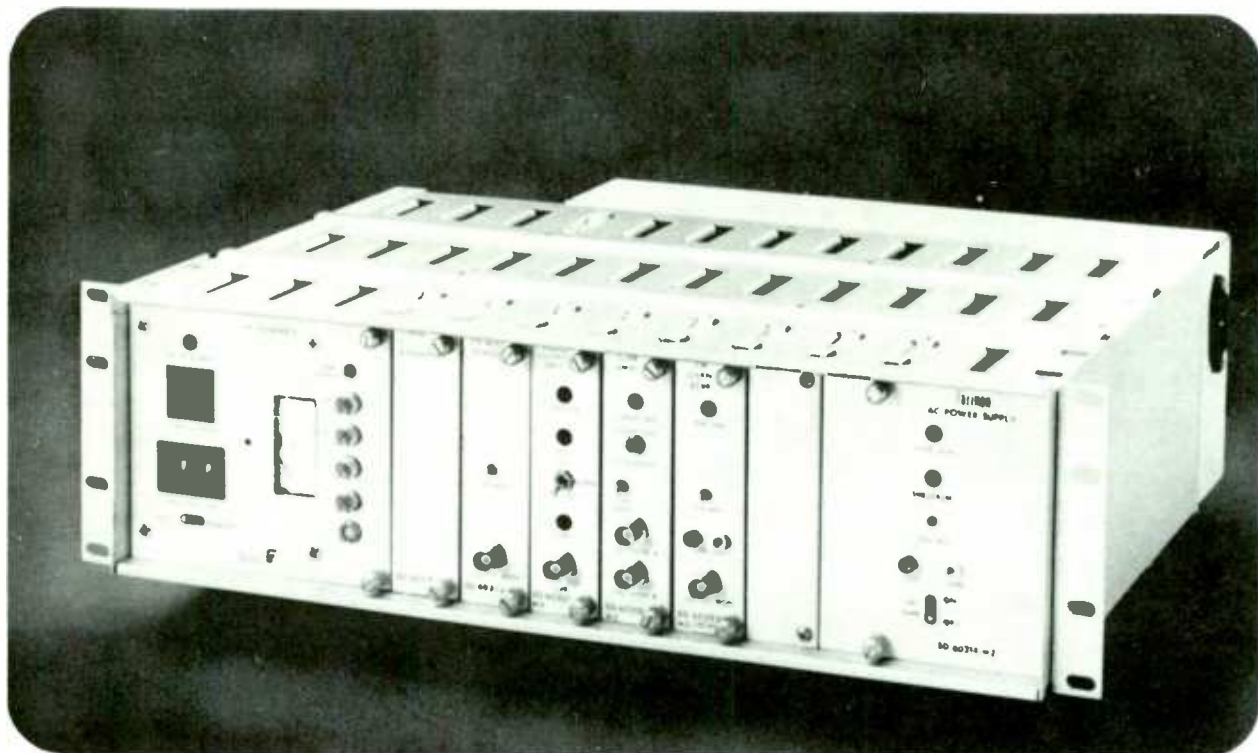

The FV2.5CR is a frequency-agile, low-noise, narrowband, 2.5-GHz receiver designed specifically for video and audio pick up from "at-the-scene" Electronic Newsgathering (ENG) crews.

FEATURES

- UP TO 60 SYNTHESIZED CHANNELS, INSTANTANEOUS PHASE LOCK – locally or remotely selectable. Covers the range from 2450 to 2690 MHz.
- CHANNEL FREQUENCIES – can be reassigned by changing plug-in EPROMS.
- 4.0-dB NOISE FIGURE – low-noise amplifier integral to the receiver.
- NARROWBAND IF SAW FILTER – for "state-of-the-art" split-channel operation.
- 81-dB DYNAMIC INPUT SIGNAL LEVEL RANGE – crews operate anywhere from maximum range to within the shadow of the receiver's antenna.
- FULLY ALARMED – with dry contacts for remote indication.
- AUXILIARY IF OUTPUT – for heterodyne interconnection.
- RFI SHIELDED – for operation in an interfering environment.

FOCUS ON RECEIVING QUALITY FOR ENG CENTRAL PICKUP

SYSTEM DESCRIPTION

The FV2.5CR ENG Receiver has been designed to provide a high degree of reception flexibility for ENG-type applications. Within the 2450- to 2690-MHz range, up to 60 synthesized channels (ROM programmable) are available with instantaneous phase locking to the selected channel. The channels are locally or remotely selectable and, in the remote mode, the selected channel number will be displayed on the receiver as well as the remote location.

The Low-Noise Amplifier (LNA) can be remotely located at the antenna, locally at the receiver, or at both locations depending upon system requirements. The LNA is equipped with a bypass (used in the event of strong signal levels), and a combine filter protecting against out-of-band signals. Overvoltage transient suppressors built into the dc power and control lines provide lightning protection to the remotely-located LNA and the receiver. The superb image rejection capability of the receiver is provided through a state-of-the-art mixer design.

A Narrowband IF SAW Filter provides maximum adjacent channel selectivity with minimum transmission degradation. Better than 81 dB of dynamic range is available. For example: using a 23-dB gain, steerable

receiving antenna, a 22-dB gain, dual helix transmitting antenna, and the maximum permitted transmitter power, an operational range extending from 1/8 mile to 250 miles can be realized. A 20-dB, minimum, fade margin will be maintained over the entire range.

An extended range acquisition feature is incorporated in the receiver. Summing of the AGC and Noise Detector voltages provides an extended AGC meter reading. This allows viewing of low RF signal levels that would be unreadable under a standard AGC meter configuration.

In the FV2.5CR receiver, key circuit functions are alarmed and furnished with dry contacts for remote indication.

A separate 70-MHz IF signal output, with AGC activated threshold alarm, is provided for heterodyne interconnection to a TSL link.

The receiver normally will operate with 115/230 Vac input voltage. DC input voltage options are available.

The FV2.5CR ENG Receiver is another major component of the "Total Concept" ENG System offering.

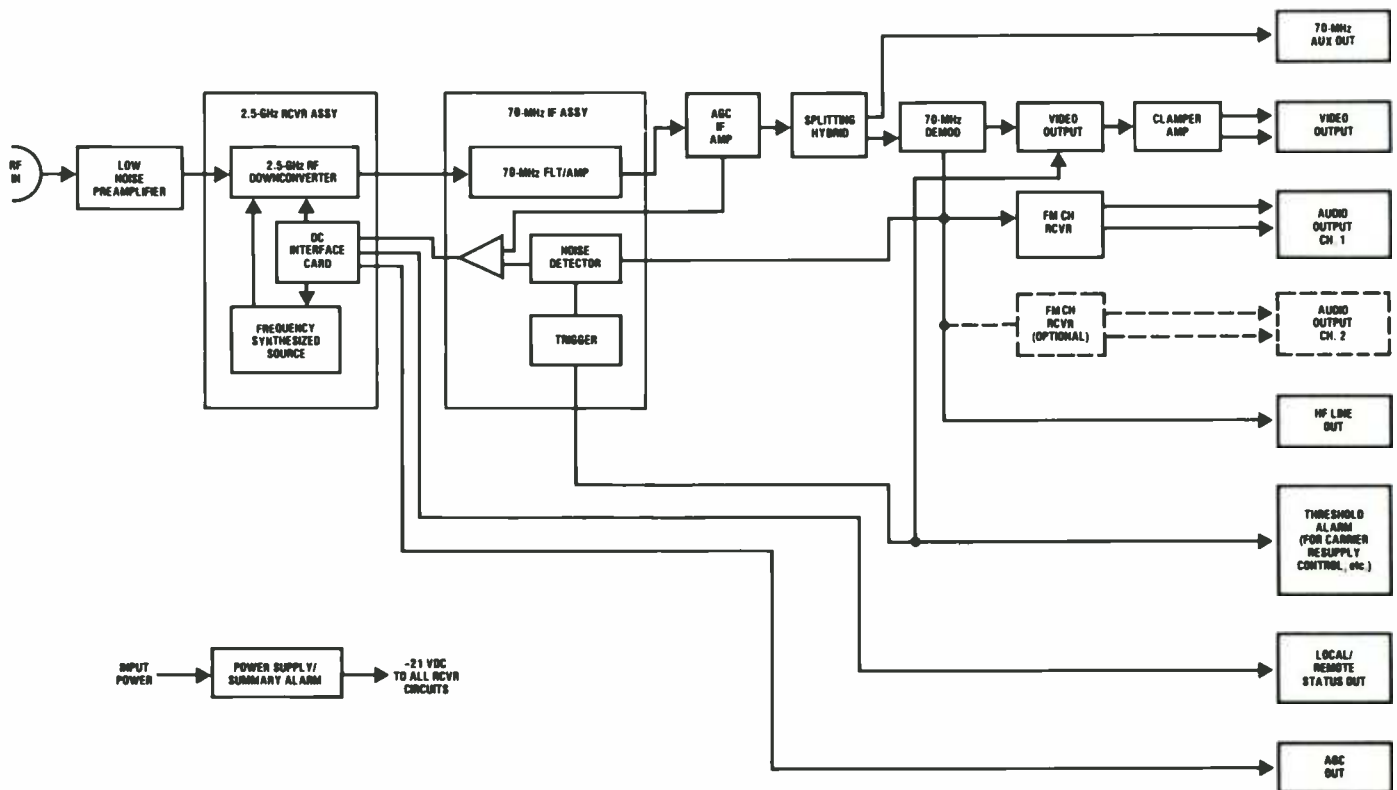

Simplified Block Diagram of Typical FV2.5CR ENG Receiver Circuitry

TYPICAL SPECIFICATIONS**General**

Tuning Band 2450 to 2690 MHz
Local Oscillator Synthesized, Up to 60 discrete frequencies

Frequency Stability $\pm 0.005\%$
Receiver System Noise Figure 4.0 dB
(Low-Noise Amplifier equipped in receiver front end.)

Selectivity at ± 8.5 MHz (10-MHz IF Filter) At least -48 dB

RF Input

Dynamic Range -5 dBm to threshold (at least 81 dB) plus 10 dB additional range for signal acquisition

Connector Precision N type
Impedance 50 ohms, unbalanced
Return Loss 20 dB

IF

Frequency 70 MHz
Bandwidth (1-dB points) 10-MHz SAW filter (standard)
16-MHz L-C filter (optional)

Auxiliary Output Level -1 dBm
Impedance 75 ohms

Temperature

Meets all specifications $+10^\circ$ to $+40^\circ\text{C}$ ($+50^\circ$ to $+104^\circ\text{F}$)

Operational -10° to $+50^\circ\text{C}$ ($+14^\circ$ to $+122^\circ\text{F}$)

Size

Uses three vertical rack mounting spaces in a 19-inch equipment rack (L x W x H)

381 x 483 x 133 mm
(15 x 19 x 5-1/4 in.)

Weight (approximate)

15.9 kg (35 lbs)

Operating Voltage Options

AC (50/60 Hz) 115 (105-125) Vac
220 (200-240) Vac
DC -24 (-22 to -28) Vdc
 $+28$ ($+22$ to $+32$) Vdc

Remote Controls

60-Channel Selection
LNA Bypass

Alarms

Summary Alarm Form "C" Dry Contacts
LO Phase Lock
Video Presence (Optional)
Clamper Fail
Subcarrier Fail
Local/Remote Status
Receiver Threshold Alarm

Transmission Performance:

(Receiver equipped with 10/16-MHz IF filter and receiving from a coordinating FV2.5MP or MF transmitter.)

Video	North American 525-Line, NTSC Service (IF Ftr = 10 MHz)	International 625-Line, PAL/SECAM Service (IF Ftr = 16 MHz)
	Output Level	1V p-p
Impedance	75 ohms, unbalanced	75 ohms, unbalanced
Frequency Response		
10 Hz to 4.2 MHz	0.6 dB p-p	—
10 Hz to 5 MHz	—	0.6 dB p-p
Line Time Distortion	1 IRE p-p	$\pm 0.5\%$
Field Time Distortion	2 IRE p-p	$\pm 1.0\%$
T-Bar Ringing	7 IRE p-p	—
2T Pulse		
Pulse to Bar Ratio	± 2 IRE	$\pm 1.0\%$
Ringing	4 IRE p-p	2.0%
12.5T Pulse		
RCL	± 2 IRE	—
RCD	± 40 ns	—
20T Pulse		
RCL	—	$\pm 1.0\%$
RCD	—	± 20 ns
Differential Gain		
10 to 90% APL	5.0%	2.0%
Differential Phase		
10 to 90% APL	3.0°	2.0°
Signal to Noise Ratio (p-p luminance/rms Noise)	70 dB	70 dB
10 kHz to 5 MHz EIA/CCIR weighted RSL = -40 dBm		
Signal to Hum Ratio (p-p luminance/p-p Hum)	53 dB	53 dB
DC to 10 kHz		

FM Audio (Program) Channels

Output Level	+ 8 dBm (0 dBm, CCIR Applications) — single-frequency test tone
Impedance	150/600 ohms, balanced
Deviation	75 kHz, peak US ENG 100 kHz, peak CCIR 200 kHz, peak US/CAN STD
Frequency Response (40 Hz to 15 kHz)	1 dB, p-p
Total Harmonic Distortion	1% at peak output level
Signal-to-Noise Ratio Flat (non-weighted)	66 dB, US ENG 70 dB, CCIR and US/CAN STD
Subcarrier Frequencies	4.83 MHz, US ENG only Other subcarriers available when FV2.5CR is equipped with the 16-MHz IF filter.

REFERENCE INFORMATION

BL 60772 — Block and Level Diagram, FV()CR Receiver

FV7CR ENG Microwave Radio Receiver

The "Central Receiver" for ENG Applications

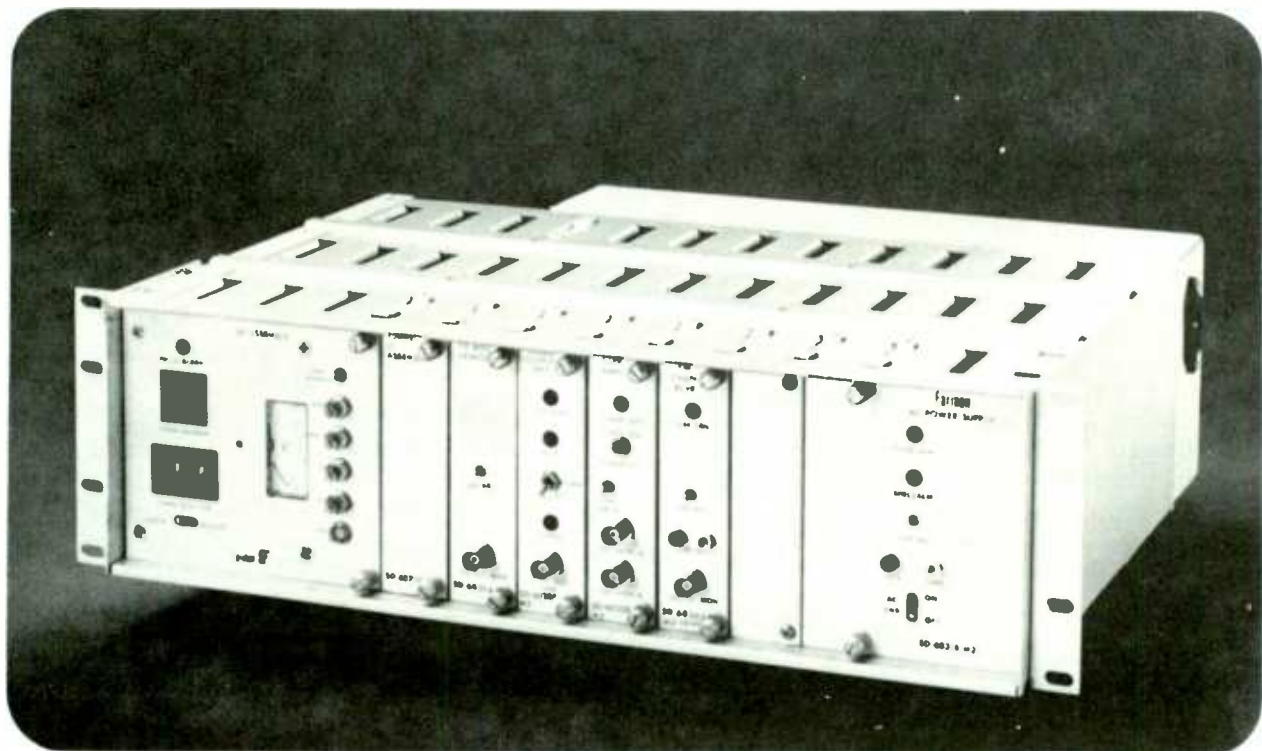

The FV7CR is a frequency-agile, low-noise, narrowband, 7-GHz receiver designed specifically for video and audio pick up from "at-the-scene" Electronic Newsgathering (ENG) crews.

FEATURES

- UP TO 60 SYNTHESIZED CHANNELS, INSTANTANEOUS PHASE LOCK – locally or remotely selectable. Covers the range from 6875 to 7125 MHz.
- CHANNEL FREQUENCIES – can be reassigned by changing plug-in EPROMS
- 6.0-dB NOISE FIGURE – low-noise amplifier integral to the receiver.
- NARROWBAND IF SAW FILTER – for "state-of-the-art" split-channel operation.
- 80-dB DYNAMIC INPUT SIGNAL LEVEL RANGE – crews operate anywhere from maximum range to within the shadow of the receiver's antenna.
- FULLY ALARMED – with dry contacts for remote indication.
- AUXILIARY IF OUTPUT – for heterodyne interconnection.
- RFI SHIELDING – for operation in an interfering environment.

FOCUS ON RECEIVING QUALITY FOR ENG CENTRAL PICKUP

SYSTEM DESCRIPTION

The FV7CR ENG Receiver has been designed to provide a high degree of reception flexibility for ENG-type applications. Within the 6875- to 7125-MHz range, up to 60 synthesized channels (ROM programmable) are available with instantaneous phase locking to the selected channel. The channels are locally or remotely selectable and, in the remote mode, the selected channel number will be displayed on the receiver as well as the remote location.

The Low-Noise Amplifier (LNA) can be remotely located at the antenna, locally at the receiver, or at both locations depending upon system requirements. The LNA is equipped with a bypass (used in the event of strong signal levels), and a combine filter protecting against out-of-band signals. Overvoltage transient suppressors built into the dc power and control lines provide lightning protection to the remotely-located LNA and the receiver. The superb image rejection capability of the receiver is provided through a state-of-the-art mixer design. A 10-dB total System Noise Figure results when the LNA is located at the antenna and a maximum of 480 feet of EW71 Elliptical Waveguide is used to interconnect with the receiver.

A Narrowband IF SAW Filter provides maximum adjacent channel selectivity with minimum transmission degradation. Better than 80 dB of dynamic range is

available. For example: using a 30-dB gain, steerable receiving antenna, a 30-dB gain transmitting antenna, and the maximum permitted transmitter power, an operational range extending from 1/8 mile to 133 miles can be realized. A 20-dB, minimum, fade margin will be maintained over the entire range.

An extended range acquisition feature is incorporated in the receiver. Summing of the AGC and Noise Detector voltages provides an extended AGC meter reading. This allows viewing of low RF signal levels that would be unreadable under a standard AGC meter configuration.

In the FV7CR receiver, key circuit functions are alarmed and furnished with dry contacts for remote indication.

A separate 70-MHz IF signal output, with AGC activated threshold alarm, is provided for heterodyne interconnection to a TSL link.

The receiver normally will operate with 115/230 Vac input voltage. DC input voltage options are available.

The FV7CR ENG Receiver is another major component of the Farinon "Total Concept" ENG System offering.

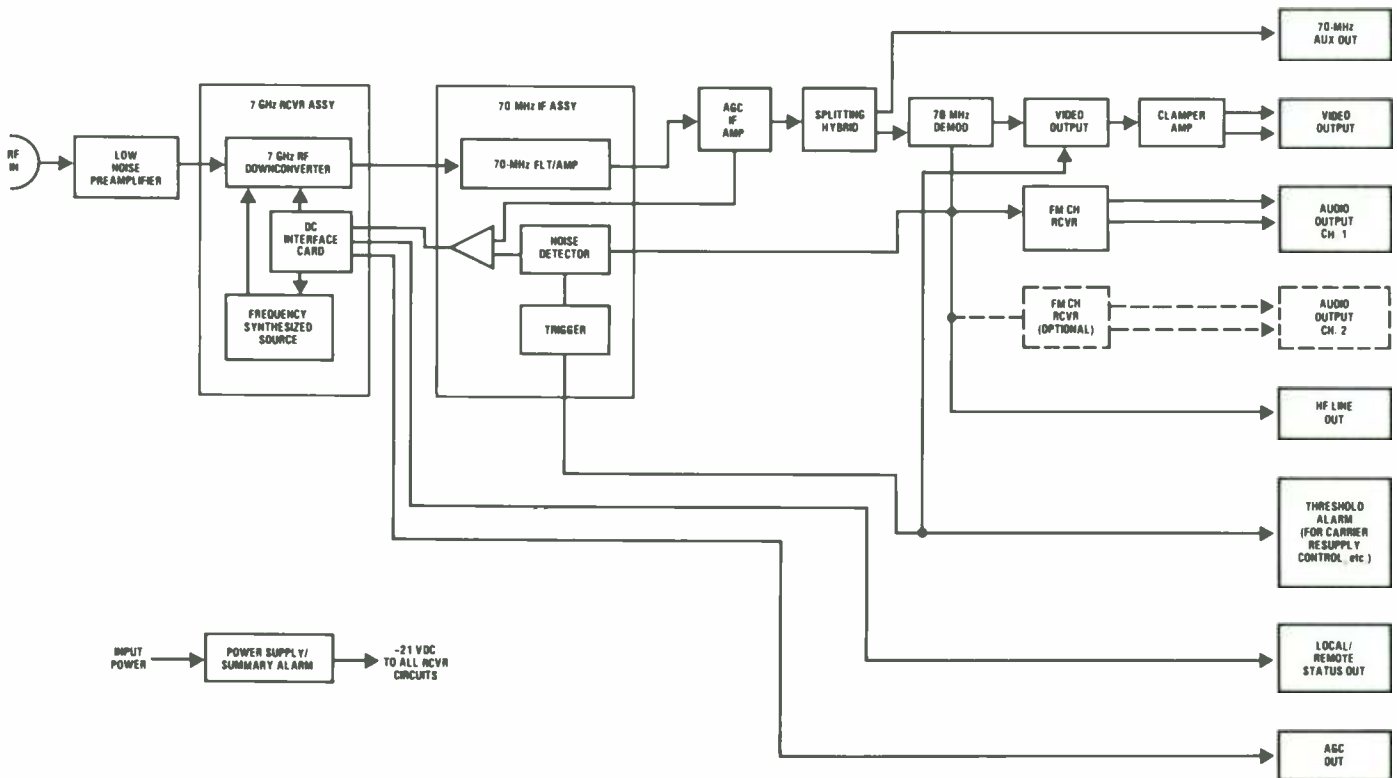

Simplified Block Diagram of Typical FV7CR Receiver Circuitry

TYPICAL SPECIFICATIONS**General**

Tuning Band	6875 to 7125 MHz
Local Oscillator	Synthesized, Up to 60 discrete frequencies
Frequency Stability	± 0.005%
Receiver System Noise Figure (Low-Noise Amplifier equipped in receiver front end.)	6.0 dB

Selectivity at ± 8.5 MHz (10-MHz IF Filter)	At least - 48 dB
--	------------------

RF Input

Dynamic Range	- 5 dBm to threshold (at least 80 dB) plus 10 dB additional range for signal acquisition
---------------	--

Connector	Precision N type
Impedance	50 ohms, unbalanced
Return Loss	20 dB

IF

Frequency	70 MHz
Bandwidth (1-dB points)	10-MHz SAW filter (standard) 16-MHz L-C filter (optional)

Auxiliary Output	
Level	- 1 dBm
Impedance	75 ohms

Temperature

Meets all specifications	+ 10° to + 40°C (+ 50° to + 104°F)
--------------------------	-------------------------------------

Operational	- 10° to + 50°C (+ 14° to + 122°F)
-------------	-------------------------------------

Size

Uses three vertical rack mounting spaces in a 19-inch equipment rack (L x W x H)

381 x 483 x 133 mm
(15 x 19 x 5- 1/4 in.)

Weight (approximate)

15.9 kg (35 lbs)

Operating Voltage Options

AC (50/60 Hz)	115 (105-125) Vac 220 (200-240) Vac
DC	- 24 (- 22 to - 28) Vdc + 28 (+ 22 to + 32) Vdc

Remote Controls

60-Channel Selection
LNA Bypass

Alarms

Summary Alarm	Form "C" Dry Contacts
LO Phase Lock	
Video Presence (Optional)	
Clamper Fail	
Subcarrier Fail	
Local/Remote Status	
Receiver Threshold Alarm	

Transmission Performance:

(Receiver equipped with 10-MHz IF filter and receiving from a coordinating FV7MP transmitter.)

	North American 525-Line, NTSC Service
--	--

Video

Output	
Level	1V p-p
Impedance	75 ohms, unbalanced
Frequency Response	
10 Hz to 4.2 MHz	0.6 dB p-p
Line Time Distortion	1 IRE p-p
Field Time Distortion	2 IRE p-p
T-Bar Ringing	7 IRE p-p
2T Pulse	
Pulse to Bar Ratio	± 2 IRE
Ringing	4 IRE p-p
12.5T Pulse	
RCL	± 2 IRE
RCD	± 40 ns
Differential Gain	
10 to 90% APL	5%
Differential Phase	
10 to 90% APL	3.0°
Signal to Noise Ratio (p-p luminance/ rms Noise)	68 dB
10 kHz to 5 MHz EIA/CCIR weighted RSL = - 40 dBm	
Signal to Hum Ratio (p-p luminance/ p-p Hum)	53 dB
DC to 10 kHz	

FM Audio (Program) Channels

Output	
Level	+ 8 dBm (single- frequency test tone)
Impedance	150/600 ohms, balanced
Deviation	75 kHz, peak (4.83 MHz subcarrier only) 200 kHz, peak (All other subcarriers)
Frequency Response (40 Hz to 15 kHz)	1 dB p-p
Total Harmonic Distortion	1% at peak output level
Signal-to-Noise Ratio Flat (non-weighted)	66 dB
Subcarrier Frequency	4.83 MHz (standard) Other subcarriers available when FV7CR is equipped with the 16-MHz IF filter.

REFERENCE INFORMATION

BL 60772 - Block and Level Diagram, FV7CR Receiver

Type 60732-M2 RF Power Amplifier



TYPE 60732-M2 RF POWER AMPLIFIER

The 60732-M2 RF Power Amplifier is designed to increase the transmission range of miniature portable microwave radio systems operating in the 2-GHz frequency range. It will provide 12 watts of output power with an input level range of 0.1–2.0 watts. The unit, located at the transmitter site, is mounted directly at the antenna. The amplifier circuitry is protected by a weather-resistant, pressurizable housing.

SPECIFICATIONS

Operating Frequency Range	1990 to 2110 MHz	Connectors (Input and Output)	Type N (female)
RF Input Power		Pressure	8 p.s.i., maximum
With 3-dB Pad	0.2W (+23.0 dBm), minimum; or 2.0W (+33.0 dBm), maximum	Operating Power Requirement	2.5A (maximum) at -24 Vdc. (Power, from an external source, is supplied through the center conductor of the same cable that carries the RF output signal from the transmitter.)
Without 3-dB Pad	0.1W (+20.0 dBm), minimum; or 1.0W (+30.0 dBm), maximum	Operating Ambient Temperature Range	-30° to +50°C (-22° to +122°F)
RF Output Power	12W (+40.8 dBm), typical	Dimensions (L x W x H)	229 x 197 x 114 mm (9 x 7-3/4 x 4-1/2 in)
Gain Flatness Variation	Less than ±0.1 dB over any 20-MHz segment of the 120-MHz frequency band.	Mounting	Mounts on 180 x 210 mm (7-1/8 x 8-1/4 in) hold pattern.
Group Delay Variation	Less than ±0.5 ns over any 20-MHz segment of the 120-MHz frequency band.		
Return Loss (Input and Output)	20 dB, minimum		
Impedance (Input and Output)	50 ohms, unbalanced		

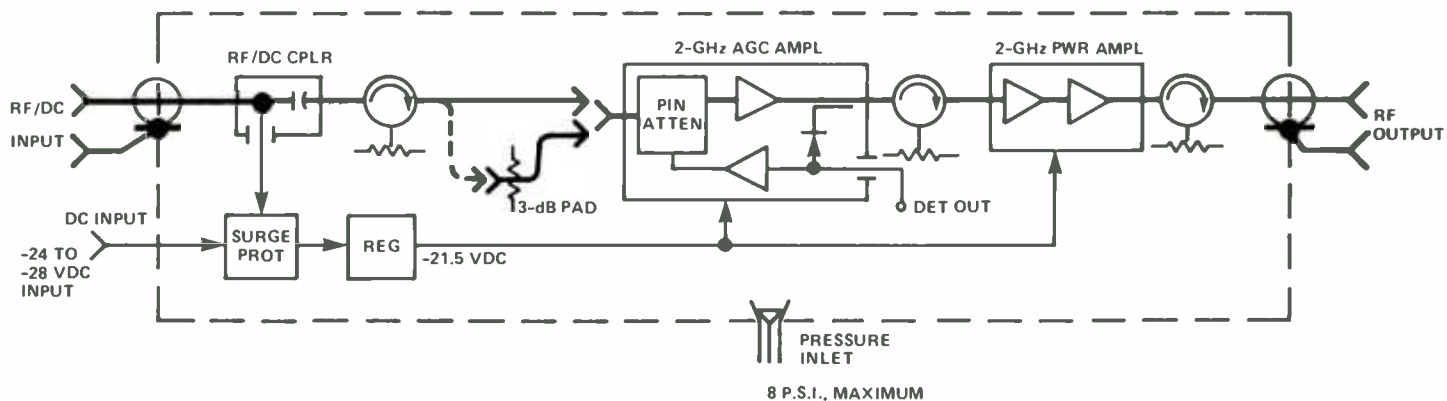

Block Diagram of SF-60732 RF Power Amplifier

Type 60576-M2 Low-Noise Preamplifier for 2/2.5-GHz Range

FEATURES

- 3-dB NOISE FIGURE
- 20-dB GAIN
- OUT-OF-BAND PROTECTION WITH COMBLINE FILTER
- THIN FILM BI-POLAR TRANSISTOR AMPLIFIERS
- ISOLATOR COUPLING
- WEATHER-RESISTANT, SUITABLE FOR ANTENNA MOUNTING
- OPTIONAL REMOTE CONTROL OF AMPLIFIER BYPASS (FOR LOW OR HIGH SIGNAL LEVELS)

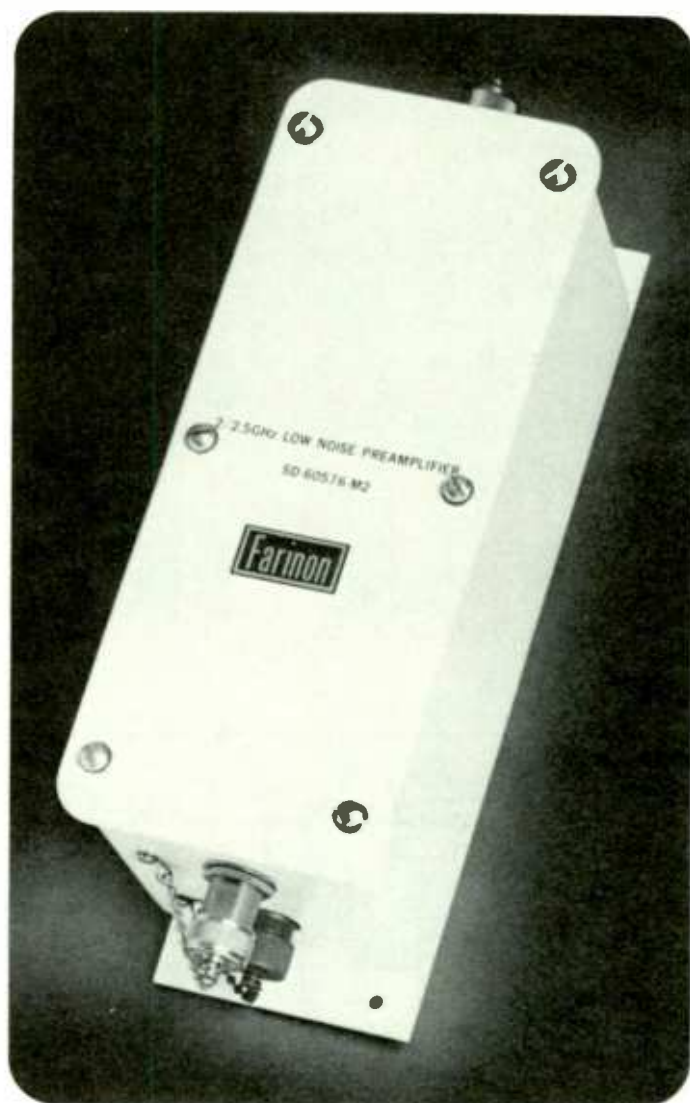

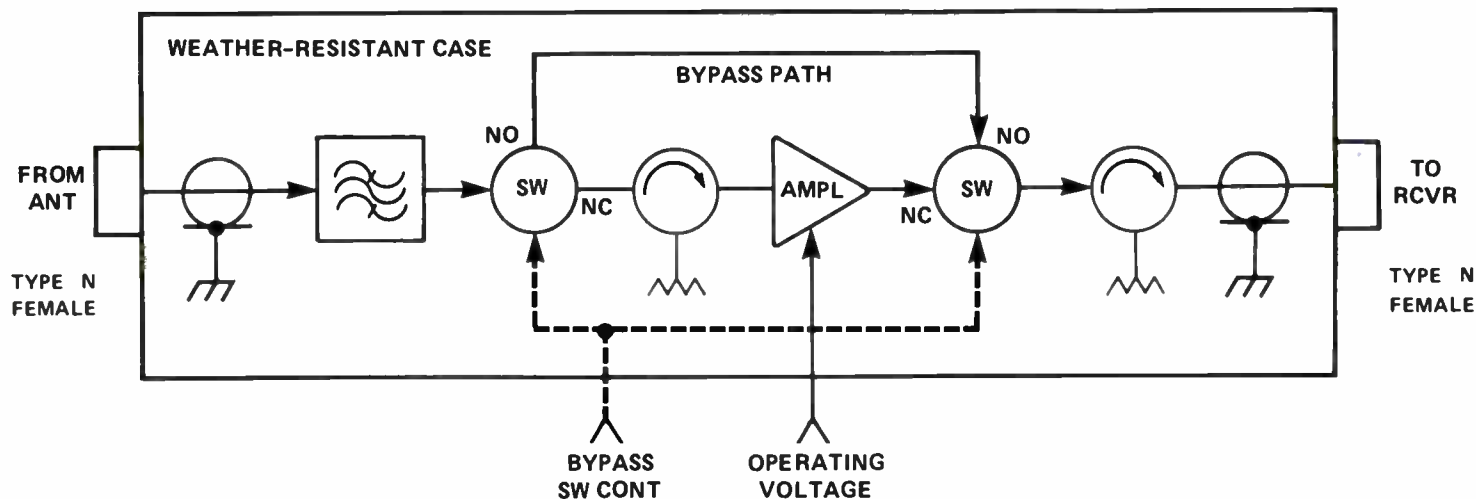

Simplified Block Diagram — Low-Noise Amplifier Assembly

DESCRIPTION

The Farinon 60576 (Model 2) Low-Noise Preamplifier is specifically designed for use with receiving antenna systems requiring long transmission lines, particularly those found in ENG/EJ applications. It will function under low signal conditions as an amplifier and, when a strong signal level is present, it can be remotely switched to bypass the amplifier. The low noise figure of 3.0 dB, with better than 20 dB of gain, assures the best possible reception sensitivity.

The relay configuration allows continued transmission should an amplifier failure occur. The versatile amplifier is of weather-resistant construction, and can be located up to 500 feet from the receiver depending on the type of cable used and the required overall system noise figure.

SPECIFICATIONS

Frequency Range Options	1990–2110 MHz or 2450–2690 MHz	
Noise Figure	1990–2110 MHz 2450–2690 MHz	3 dB, maximum 4.5 dB, maximum
Gain	1990–2110 MHz 2450–2690 MHz	20 dB, minimum 15 dB, minimum
Power Out (1-dB Compression)		+8 dBm
Gain Flatness and Slope		Less than ± 0.1 dB amplitude variation over any 20-MHz segment of the operating range.
Return Loss		Greater than 20 dB
RF Input/Output Impedance		50 ohms
RF Input/Output Connectors		Type N female
DC Power Requirements		
Voltage:	Amplifier Relays	-21 Vdc, regulated Optional -21 to -24 Vdc, unregulated or ground
Current:	Amplifier Relays	35 mA 200 mA
Operating Temperature Range		-30° to +50°C (-22° to +122°F)
Mounting		Flush-mounts on 2.25 x 8.00 inch hole pattern
Dimensions (L x W x H) (Approximate)		267 x 102 x 114 mm (10½ x 4 x 4½ in)
Weight (Approximate)		1.2 kg (2.5 lbs)

TYPE 60515 power amplifier for television broadcasters



FEATURES

- 2/2.5-GHz STL/ICL (ICRS) Bands (1990-2110, 2301-2422, 2450-2700 MHz)
- 20 Watts, Minimum (+ 43 dBm) Power Output at 1990 to 2120 MHz
- 15 Watts, Minimum (+ 41.8 dBm) Power Output at 2450 to 2700 MHz
- Requires Only + 29 to + 33 dBm (0.8 to 2.0 Watts) Drive Level
- All Solid-State Construction
- Small Physical Size, Two Standard Rack Mounting Spaces

DESCRIPTION

The Type 60515 RF Power Amplifier is used in a microwave transmission system to provide 20 watts of output power in the 2-GHz frequency band, and 15 watts of power in the 2.5-GHz band.

The unit provides self-contained metering and alarm circuitry. Metered functions include Amplifier Current, Amplifier Power Output, and DC Operating Voltage. Provision is also made for the metering of external voltages and currents. Internal alarm functions include Low RF Power Output (– 3 dB) and Fusing. A Form "C" Summary Alarm Circuit is available for external alarm interconnection.

type 60367 portable test unit for television transmission

A high-performance portable video/program modem for temporary drop, insert or testing at a fixed IF heterodyne microwave repeater.

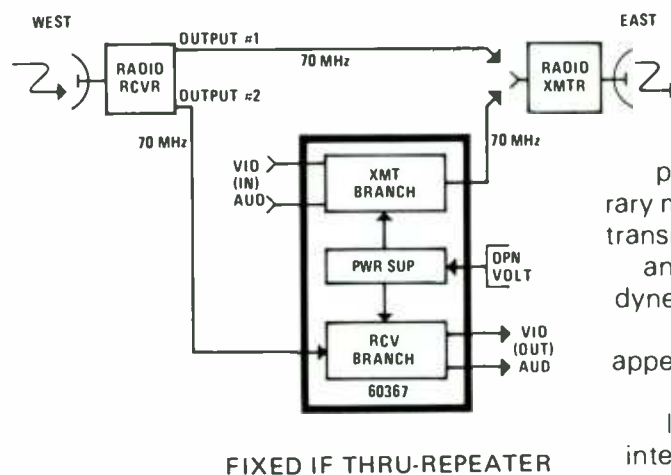
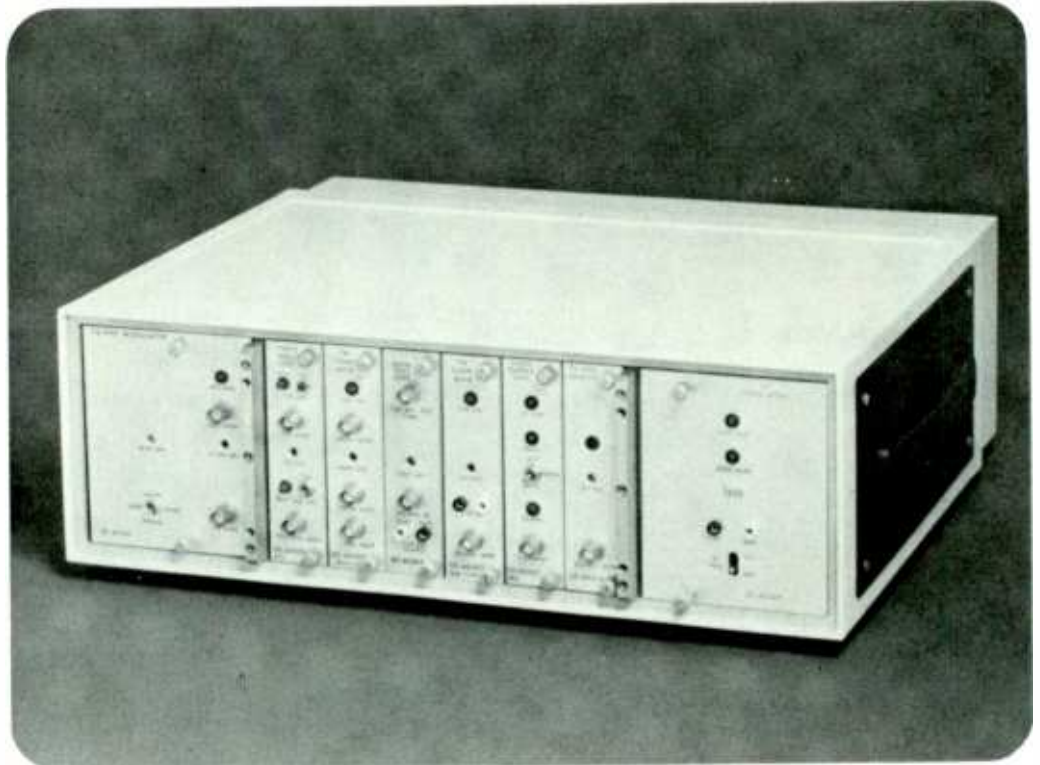

Suitable for numerous fixed and portable microwave radio test applications. The 60367 Portable Test Unit is primarily intended as a temporary modem for drop and/or insert transmission service, or testing, at an IF repeater of a fixed heterodyne microwave system. Composite video and program audio appear as separate line interfaces, at standard input and output levels and impedances. Radio interconnection is at the conventional 70-MHz IF point. A typical temporary repeater arrangement is shown at the left.

FEATURES

- High-quality, full-performance modem/transmission equipment.
- For 5 or 6-MHz video (525-line NTSC No. American or 625-line PAL/SECAM International Service)
- For all standard FM program subcarrier frequencies. Special frequencies are available on order
- Light-weight, weatherproof mechanics
- Operates for -24 or -48 Vdc, or from 115 or 220 Vac
- Self-contained deviation test unit for setting modulation deviation of the FM radio carrier
- Plug-in circuit modules of the portable tester are interchangeable with those of the FV40 video transmission/modem equipment that usually is used with FV-series Farinon microwave – provides spares backup for emergencies

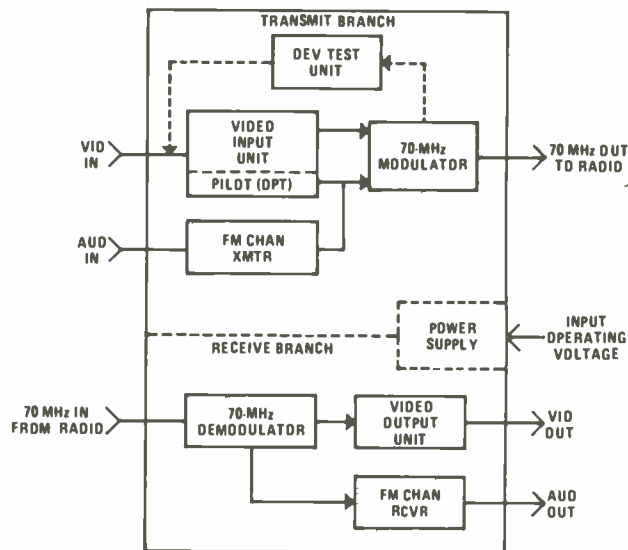

60367 Portable Test Unit, simplified block diagram.

TECHNICAL CHARACTERISTICS

Transmit Branch

Video Input Level	0 dBV, nominal; adjustable for signal variation of -3 to +5 dB
Impedance	75 ohms, unbalanced
Lowpass Filter Options	dc to 4.2, 5, or 6 MHz dc to 10 MHz without filter
Input Return Loss	30 dB, minimum, dc to 8 MHz
Audio Input Level	Adjustable for -20 to +18 dBm to produce rated maximum modulation
Impedance	75 ohms, unbalanced or 600/150 ohms balanced
Subcarrier Deviation	200 kHz, peak, deviation maximum
Frequency Response	1 dB p-p, 40 Hz to 100 kHz
70-MHz Output	-10 to +10 dBm
Impedance	75 ohms, unbalanced
Optional Pilot Frequencies	6.199, 8.500, 9.023, 11.88, or 13.627 MHz

Receive Branch

70-MHz Input Level	-7 to +1 dBm
Impedance	75 ohms, unbalanced
Video Output Level	0 dBV
Impedance	75 ohms, unbalanced
Output Return Loss	30 dB, minimum, dc to 8 MHz
Audio Output Level	Adjustable for -20 to +18 dBm when rated modulation is produced at the transmit terminal
Impedance	75 ohms, unbalanced or 600/150 ohms, balanced

FM Subcarrier Frequency-Set Options (MHz)

6.2	6.7	7.5	8.2	Std. U.S. FM Subcxrs	
6.17	6.8	7.67	8.3	Std. Canadian Subcxrs	
7.02	7.5	8.065	8.59	CCIR FM Subcxrs	
5.14	5.36	5.79	6.2	6.8	Earth Station Applications
4.83					Narrow-band Operation (ENG)
5.8	6.4				Bell System Network Transmission

Notes:

1. Other coordinated FM channel frequency sets are available on order.
2. 7.02 MHz is lowest usable subcarrier for 625-line systems.
3. A 4.2-MHz video passband must be used with subcarriers below 5.6 MHz

Video Service

525-line or 625-line composite monochrome or color, with or without sound subcarrier, sync negative transmission mode, emphasis is standard CCIR/Bell System weighting.



HARRIS

9 Meter Satellite Earth Station Antennas

- 50.0 dB gain at 4 GHz
- Available with kingpost pedestal for rapid satellite changeover
- All-aluminum dish and backup structure
- Applications: Broadcast TV downlinks and uplinks, private networks
- Turn-key installation available with Harris LNA, receivers, all accessories

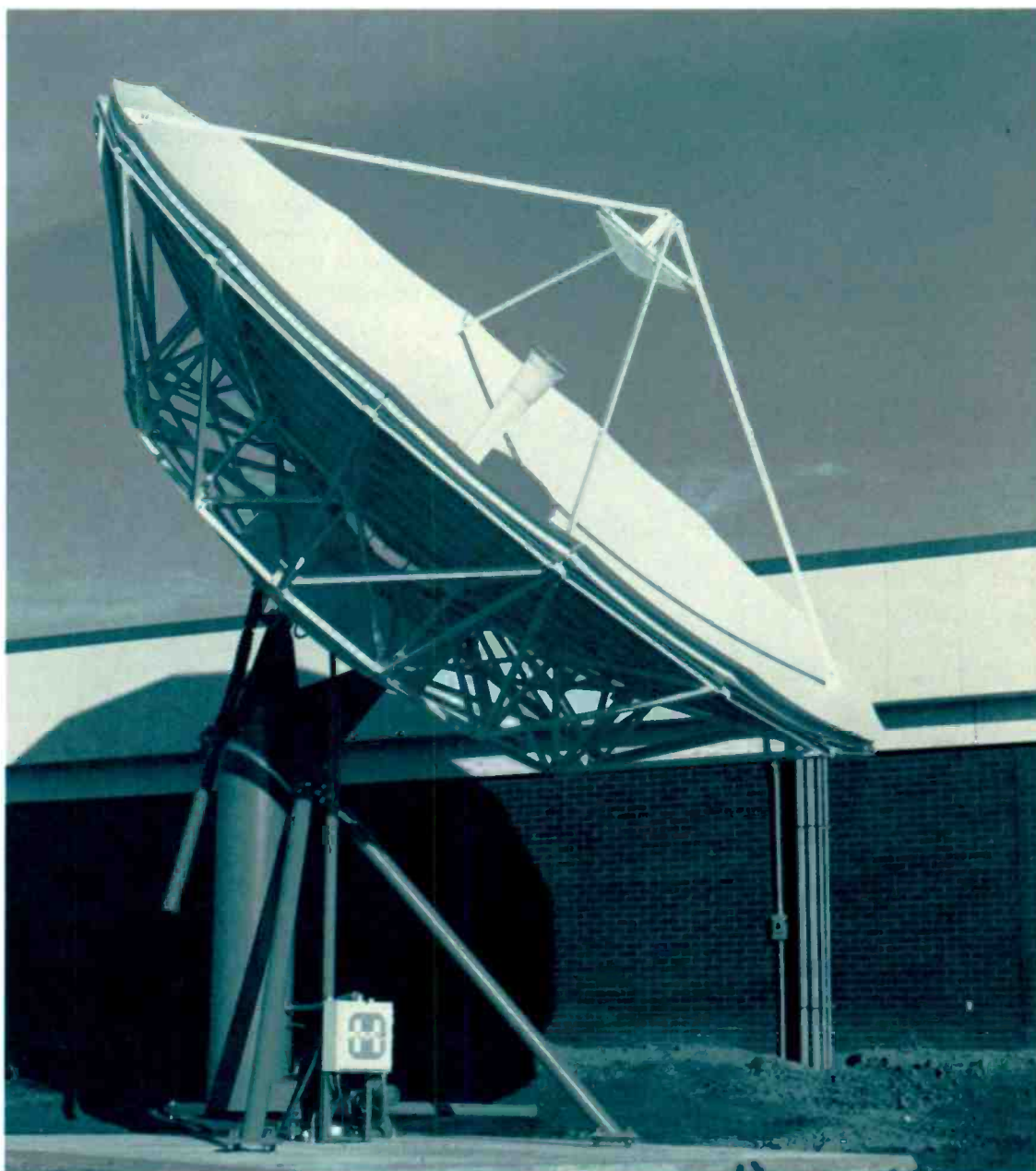

HARRIS 9 METER SATELLITE EARTH STATION ANTENNAS

Harris 9-meter antennas are designed for use by the broadcast industry for television and audio uplinks and downlinks, and for private and corporate voice and data network earth stations. The antenna design combines Harris' mechanically-superior rigid structural design techniques with advanced electrical design for years of outstanding performance. The main reflector has 16 panels, specially contoured for use with high-efficiency Cassegrain feed systems. The system provides 50.0 dB gain at four GHz.

Model 5251 9-meter antenna features a kingpost pedestal for adjustable positioning toward any visible satellite. In the motorized version, simultaneous drive in azimuth, elevation and polarization allow satellite switchover between any two U.S. domestic satellites in 72 seconds or less, at most U.S. locations.

STANDARD CONFIGURATIONS:

MODEL 5251: Antenna with kingpost pedestal. The following drive options are available for use with this antenna:

- Handcrank azimuth, elevation and polarization adjustment (standard).
- Model 7022 ac motorized dual speed drive. Drive rate is one degree per second. Drive system includes remote control system and remote angle readout. The system provides simultaneous drive in azimuth, elevation and polarization. The control system includes thumbwheel switches to preset all angles for any two satellites, for simplified rapid switchover. For additional information, refer to the technical data sheets for Model 7022 Antenna Drive System.
- Other drive systems are available for special requirements.

FEED OPTIONS: The following feed systems are available:

- Model 6713 dual polarization receive-only feed. Linear polarization is standard; circular polarization is optional.
- Model 6720 dual port transmit/receive feed. Linear orthogonal polarization is standard; linear copolar polarization (for use with Comstar) is optional. Circular polarization version of this feed is also optional.
- Model 6727 frequency reuse (four port) linear polarization transmit/receive feed.
- Model 6734 frequency reuse (four port) circular polarization transmit/receive feed.

ADDITIONAL SYSTEM OPTIONS:

- Feed deicing
- Full reflector deicing
- Half reflector deicing
- Extended (110°) azimuth range

MECHANICAL SPECIFICATIONS

Azimuth Travel90° (110° optional)
Elevation Travel3° to 90°
Weight - Reflector3500 pounds (1590 kg)
Weight - Pedestal3200 pounds (1450 kg)
Shipping Weight (Typical)7750 pounds (3515 kg)
Shipping Volume7.5 x 8 x 30 feet; 1800 cubic feet (2.3 x 2.4 x 9.2 m; 51 cubic m)
FinishReflector and backup structure: heat-diffusing white paint. Pedestal: red oxide primer, two top coats of enamel
Foundation Size22.0 x 22.0 x 1.5 feet (6.7 x 6.7 x 0.46 cm)
Concrete Volume27 cubic yards (20.7 cubic m)



Harris 9-Meter Antenna
Las Vegas, Nevada

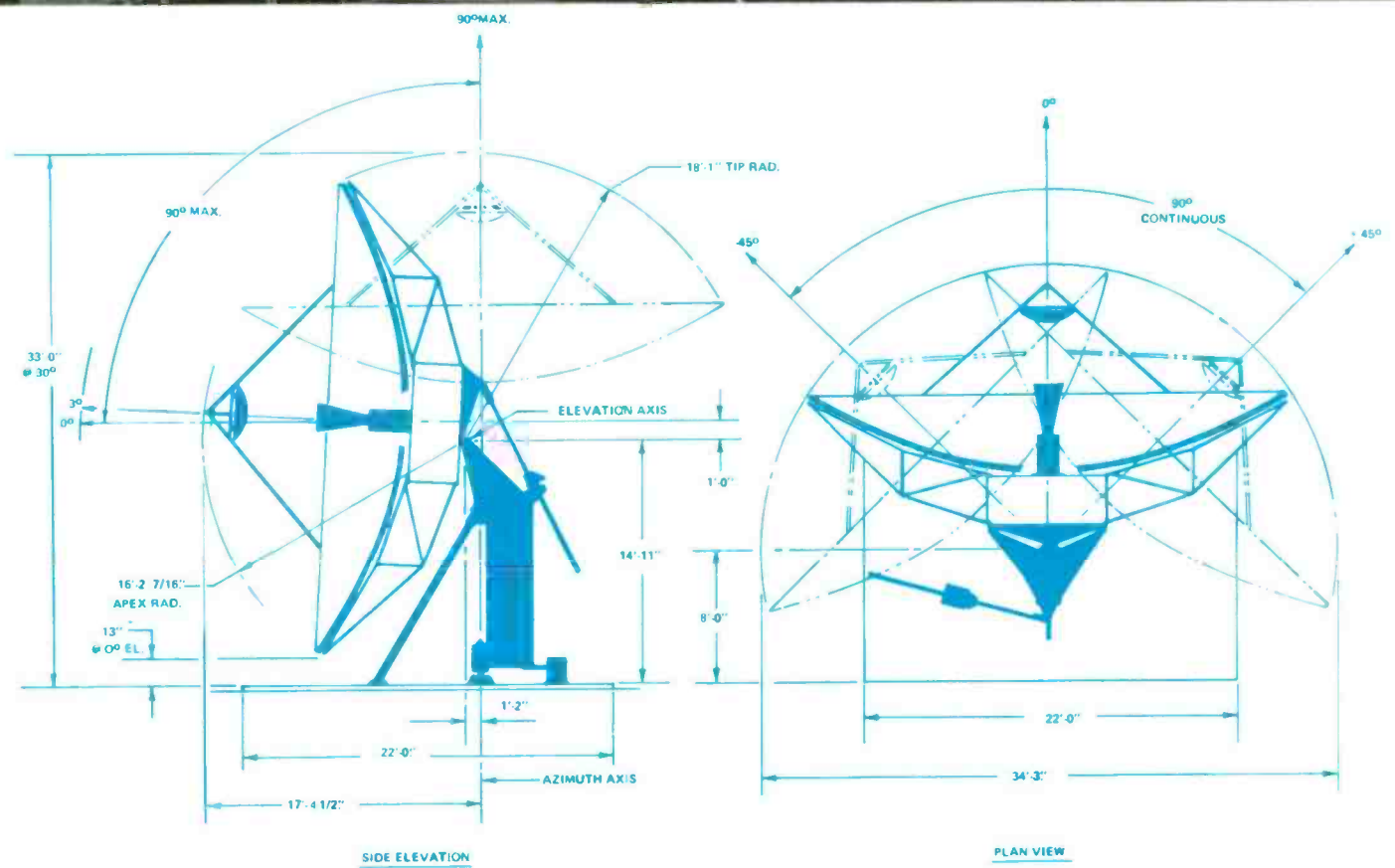

SPECIFICATIONS

Electrical Specifications:

Receive Frequency	3.7 to 4.2 GHz
Transmit Frequency	5.925 to 6.425 GHz
Antenna Gain in dB at 4 GHz	50.0
Antenna Gain in dB at 6 GHz	53.2
Sidelobe Patterns:	
First Sidelobe	-14 dB
1° to 48°	32 - 25 log ₁₀ θ
48° to 180°	-10 dB _i
VSWR (Receive and Transmit)	1.3:1 or better
Axial Ratio:	
Linear Polarization	35 dB (typical 40 dB)
Frequency Reuse Circular Polarization	0.5 dB (INTELSAT IVA, V)
Tx/Rx Circular Polarization	2.9 dB (INTELSAT III, IV)
Antenna Noise Temperature in °K	5° elevation: 46
	10° elevation: 33
	20° elevation: 21
	40° elevation: 19
Antenna Beamwidth in Degrees	At receive, -3 dB: 0.55
	At receive, -15 dB: 1.2
	At transmit, -3 dB: 0.4
	At transmit, -15 dB: 0.8
Typical G/T in dB at 20° Elevation Angle, Clear Horizon, 4 GHz.	With 40°K LNA: 31.5
	With 100°K LNA: 28.8
Polarization Rotation.	Manual ±90° (linear FRU feeds ±50°), optional remote motor drive and readout

Environmental Specifications:

Fully Operational Winds	45 mi/h (73 km/hr), gusts to 60 mi/h (97 km/hr)
Degraded Operation	60 mi/h (97 km/hr), gusts to 90 mi/h (145 km/hr)
Survival Winds (any position)	125 mi/h (200 km/hr)
Ambient Temperature (Operational)	-25°C to +45°C (-13°F to 113°F)
Ambient Temperature (Survival)	-30°C to +70°C (-22°F to 158°F)
Rain (Operational and Survival)	Up to 4 in./hr (10 cm/hr)
Relative Humidity (Operational and Survival)	0% to 100% with condensation
Solar Radiation	360 BTU/hr/sq ft
Radial Ice (Operational)	1/4 inch (0.6 cm) on all surfaces except reflector, with deicing heaters energized
Radial Ice (Survival)	1 inch (2.6 cm) on all surfaces; 1/2 inch (1.3 cm) on all surfaces with 80 mi/h (130 km/hr) wind gusts
Shock and Vibration	As encountered during shipment by commercial air, rail or truck
Corrosive Atmosphere	As encountered in coastal regions and/or heavily industrialized areas
Seismic (Survival)	0.2 G's horizontal, 0.1 G's vertical



HARRIS

6.1 Meter Satellite Earth Station Antennas

- Gain 46.5 dB at 4 GHz
- Industry's top mechanical quality
- Cassegrain feed design provides high efficiency
- Applications: CATV, private networks, portable uplinks, broadcast terminals
- Turn-key installation available with Harris LNA, receivers, all accessories
- Two pedestal designs available

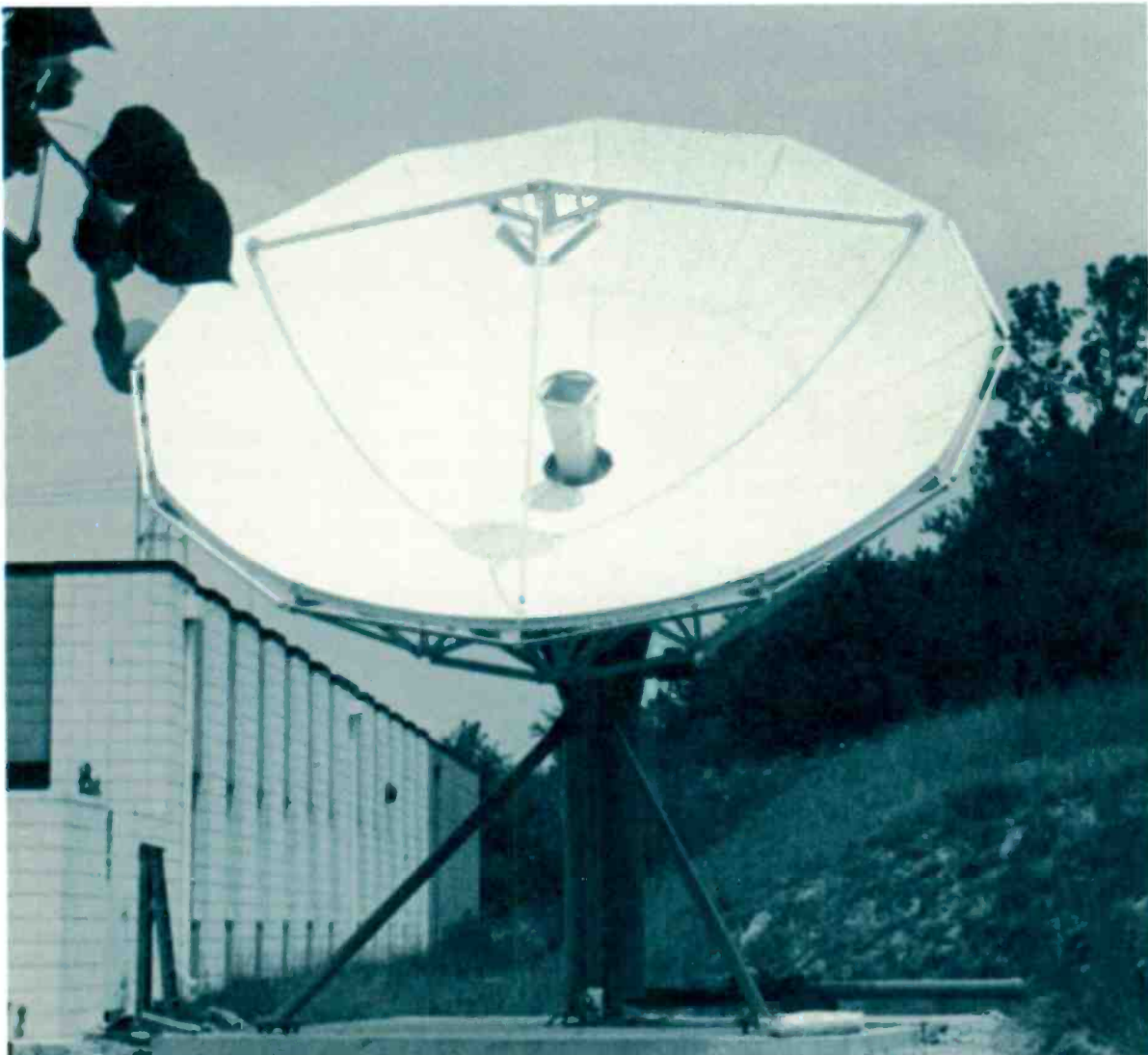

HARRIS 6.1 METER SATELLITE EARTH STATION ANTENNAS

The Harris 6.1-Meter C-band antenna couples excellent performance with the industry's top mechanical quality. Because of its size and efficiency, it provides extra gain margin for TV receive-only stations anywhere in the continental U.S. It can also be used for both transmit and receive in a variety of other applications such as TV uplink and private commercial or government satellite networks, both within the U.S. and overseas.

Cassegrain feed design provides high efficiency and protected hub mounting for low noise amplifiers. Two pedestal designs are available:

- The standard pedestal is a rigid galvanized steel space frame, designed to orient the antenna toward a single satellite. Reorienting to other satellites, if required, is performed manually. This antenna system is extremely rigid, and has withstood hurricane-force winds without losing video signals.
- A kingpost pedestal is designed for manual or motorized remote positioning in azimuth, elevation and polarization. This antenna is designed for applications where signals will be received from two or more satellites. In the motorized drive version, the antenna can be repositioned from any one satellite to any other in the antenna's range in 72 seconds or less, for most U.S. locations.

STANDARD CONFIGURATIONS:

MODEL 5241: Antenna with standard pedestal, receive-only configuration. Includes Model 6712 dual port linear polarization receive-only feed. Dual port circular polarization version of this feed is optional.

MODEL 5242: Antenna with kingpost pedestal, receive-only configuration. Includes Model 6712 dual polarization linear polarized receive-only feed. (Circular polarization optional.) The following drive systems are available:

- Handcrank azimuth, elevation and polarization adjustments (standard).
- Model 7022 ac motorized dual speed drive. Drive rate is one degree per second. Drive system includes remote angle readout. The system provides simultaneous drive in azimuth, elevation and polarization. The control system includes thumbwheel switches to preset all angles for any two satellites, for simplified rapid switchover. For additional information, refer to the technical data sheets for Model 7022 Antenna Drive System.
- Other drive systems are available for special requirements.

MODEL 5243: Antenna with standard pedestal, transmit/receive configuration. The following feed systems are available:

- Model 6702 dual port transmit/receive feed. Linear polarization with orthogonal transmit and receive ports are standard; copolar ports (for use with Comstar satellites) optional; circular polarization also optional.
- Model 6726 frequency reuse (four port) linear polarization transmit/receive feed.
- Model 6733 frequency reuse (four port) circular polarization transmit/receive feed.

MODEL 5244: Antenna with kingpost pedestal, transmit/receive configuration. Drive systems available are same as Model 5242; feed systems available are same as Model 5243.

Additional System Options:

- Feed deicing
- Full reflector deicing
- Half reflector deicing
- For kingpost models, extended (110°) azimuth range is available

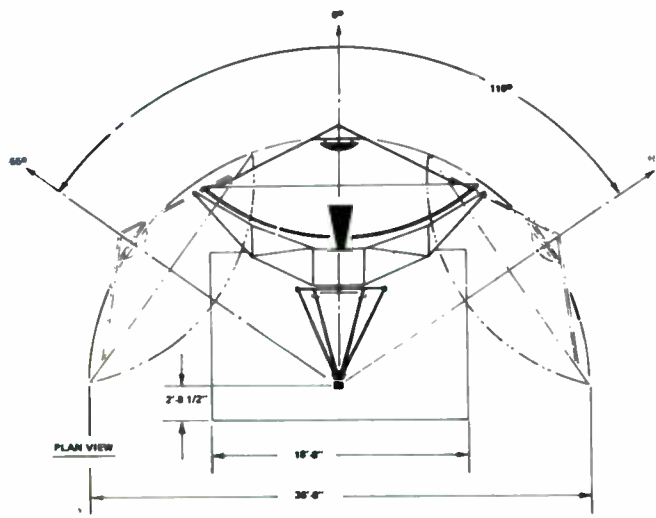
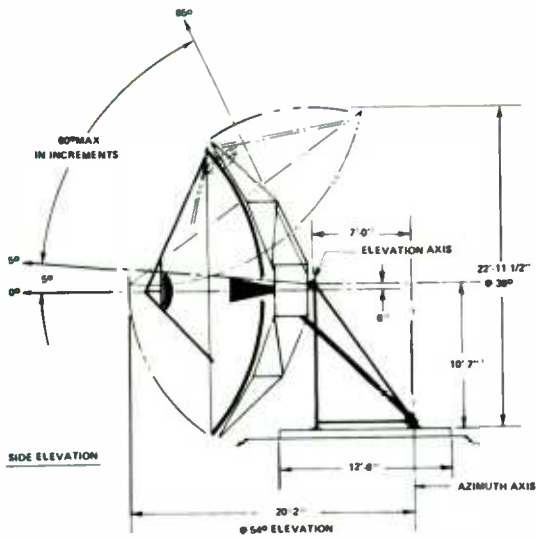

6.1-Meter Antenna with Standard Pedestal

MECHANICAL SPECIFICATIONS

Azimuth Travel	110° (may be extended by increasing pad size)
Elevation Travel	5° to 65°
Weight - Reflector	1375 pounds (625 kg)
Weight - Pedestal	925 pounds (420 kg)
Shipping Weight (Typical)	3300 pounds (1500 kg)
Shipping Volume	1200 cubic feet (34 cubic m)
Foundation Size	12.5 x 18.5 x 1.5 feet (3.8 x 5.6 x 0.46 m)
Concrete Volume	13 cubic yards (10 cubic m)
Reinforcing Steel	775 pounds (350 kg) Number 4
Soil Bearing Capacity	2000 pounds/square feet (10,000 kg/sq. m)

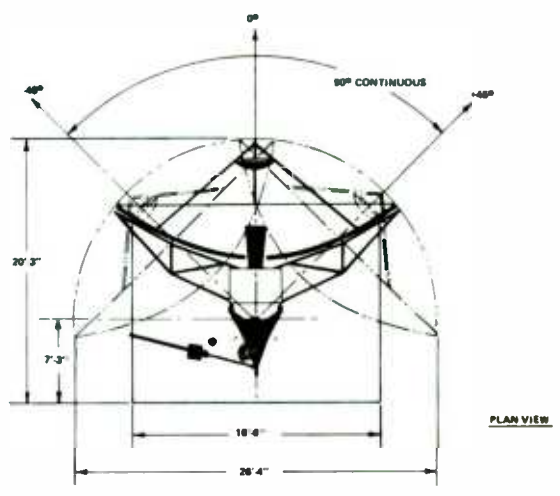
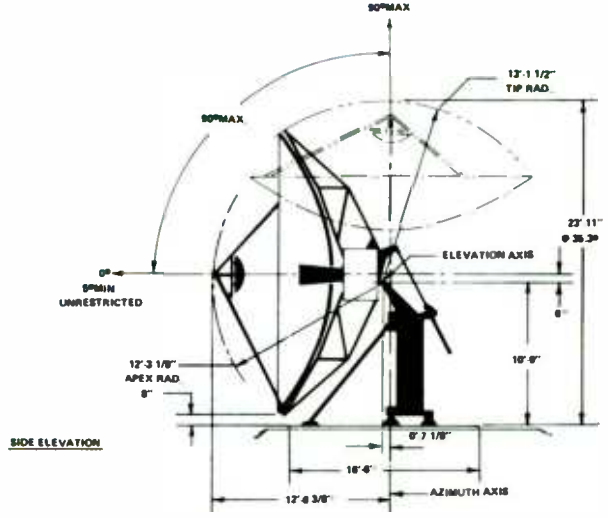

6.1-Meter Antenna with Kingpost Pedestal

MECHANICAL SPECIFICATIONS

Azimuth Travel	90° (110° optional)
Elevation Travel	5° to 90°
Weight - Reflector	1375 pounds (625 kg)
Weight - Pedestal	1500 pounds (680 kg)
Shipping Weight (Typical)	3900 pounds (1770 kg)
Shipping Volume	1400 cubic feet (40 cubic m)
Foundation Size	16.5 x 16.5 x 1.5 feet (5.0 x 5.0 x 0.46 m)
Concrete Volume	15.2 cubic yards (11.5 cubic m)
Reinforcing Steel	1335 pounds (605 kg) Number 5
Soil Bearing Capacity	2000 pounds/square feet (10,000 kg/sq. m)

SPECIFICATIONS

ELECTRICAL SPECIFICATIONS:

Receive Frequency	3.7 to 4.2 GHz
Transmit Frequency	5.925 to 6.425 GHz
Antenna Gain in dB at 4 GHz	46.5 dB
Antenna Gain in dB at 6 GHz	49.0 dB
Sidelobe Patterns:	
First Sidelobe	-14 dB
1° to 48°	32-25 log ₁₀ θ
48° to 180°	-10 dBi
VSWR (Receive and Transmit)	1.3:1 or better
Axial Ratio:	
Linear Polarization	35 dB (typical 40 dB)
Frequency Reuse Circular Polarization	0.5 dB (INTELSAT IVA, V)
Tx/Rx Circular Polarization	2.9 dB (INTELSAT III, IV)
Antenna Noise Temperature in °K	5° elevation: 46
	10° elevation: 33
	20° elevation: 21
	40° elevation: 18
Antenna Beamwidth in Degrees:	At receive, -3 dB: 0.85
	At receive, -15 dB: 1.7
	At transmit, -3 dB: 0.56
	At transmit, -15 dB: 1.2
Typical G/T in dB at 20° Elevation Angle, Clear	
Horizon, 4 GHz	With 40°K LNA: 28.0
	With 100°K LNA: 25.3
Polarization rotation:	Manual ±90° (linear FRU feeds ±50°), optional remote motor drive and readout

ENVIRONMENTAL SPECIFICATIONS:

Operational Winds	Gusts to 60 mi/h (97 km/hr)
Degraded Operation	60 mi/h (97 km/hr), gusts to 90 mi/h (145 km/hr)
Survival Winds (Any Position)	125 mi/h (200 km/hr)
Ambient Temperature (Operational)	-25°C to +45°C (-13°F to 113°F)
Ambient Temperature (Survival)	-30°C to +70°C (-22°F to 158°F)
Rain (Operational and Survival)	Up to 4 in./hr (10 cm/hr)
Relative Humidity (Operational and Survival)	0% to 100% with condensation
Solar Radiation	360 BTU/hr/sq ft
Radial Ice (Operational)	1/4 inch (0.6 cm) on all surfaces except reflector, with deicing heaters energized
Radial Ice (Survival)	1 inch (2.6 cm) on all surfaces; 1/2 inch (1.3 cm) on all surfaces with 80 mi/h (130 km/hr) wind gusts
Shock and Vibration:	As encountered during shipment by commercial air, rail or truck
Corrosive Atmosphere	As encountered in coastal regions and/or heavily industrialized areas
Seismic (Survival)	0.2 G's horizontal, 0.1 G's vertical



HARRIS

Model 6521 Satellite Broadcast Video Receiver

- Full broadcast-quality video and audio fidelity
- Dual conversion
- Video static threshold less than 8 dB—typically 7 dB. Subjective threshold performance is even better
- 24 channel frequency-agile synthesizer
- Excellent non-linear and linear distortion characteristics
- Modular construction

The Harris Model 6521 Satellite Video Receiver is designed to provide outstanding reception quality for the television broadcast industry, in both domestic and INTELSAT applications. It provides full satellite channel

frequency agility and a refined tracking filter Threshold Extension Demodulator for good video quality even under adverse conditions.

The receiver is designed for remote control of channel selection and automatic polarization switching. The frequency-agile synthesizer for channel selection provides either 24 or 12-channel operation, as needed to match the satellite characteristics.

Receiver Model 6521 is a component of the Harris Broadcast Satellite TV Receive-Only System. On command, this system reorients a precision satellite antenna to a preselected satellite, and locks on the desired channel—all in the time required for a commercial break.

For applications where rapid frequency agility is not needed, the receiver is also available with channel selection by interchanging crystals. A front panel opening is provided for crystal change. No readjustment of any kind is needed when channels are changed.

The receiver is designed with all active components in replaceable modules. Options such as additional audio subcarrier demodulators are added by installing plug-in cards. The technical manual provides complete instructions for rapid troubleshooting by module replacement.

The Model 6521 Receiver complies with EIA Standard RS 250B and CCIR Recommendation AA.

OPTIONS:

- Remote channel tuning
- Automatic polarization switching
- Up to four audio subcarriers
- Other video formats such as 625 line
- IF bandwidths other than 36 MHz
- Crystal-controlled channel selection

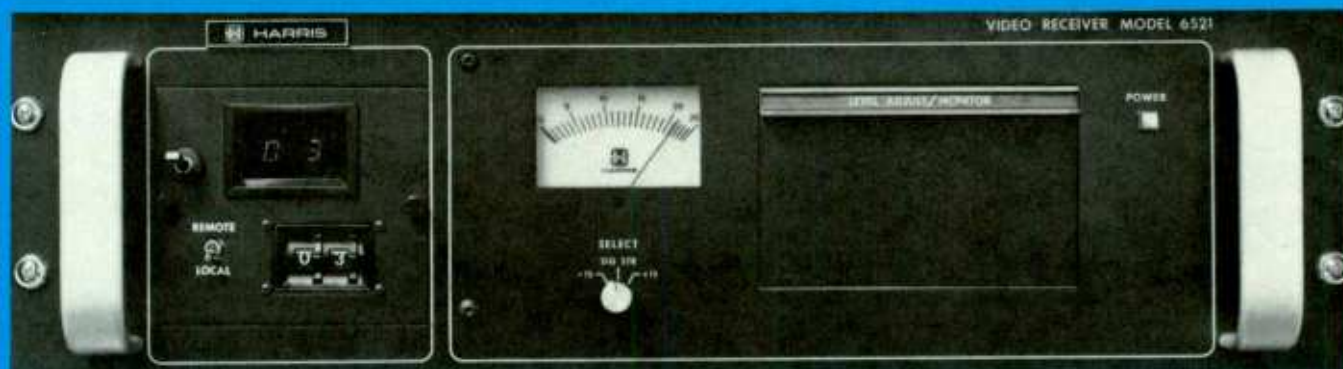



MODEL 6521 SPECIFICATIONS

RF INPUT:

Maximum Level: -30 dBm.
 Frequency: 3700 to 4200 MHz, in 20 MHz or 40 MHz increments, frequency-agile synthesizer. Crystal control optional.
 Impedance: 50 ohms.
 Return Loss: ≥ 15 dB.
 Noise Figure: ≤ 15 dB.
 Image Rejection: > 60 dB.

IF:

Intermediate Frequency: 70 MHz.
 IF Bandwidth: 36 MHz, others optional.
 Impedance: 75 ohms, unbalanced.

BASEBAND:

Deemphasis: 525 line per CCIR recommendation 405-1, 625 line optional.
 Deviation Range: 6 to 12 MHz peak at deemphasis cross-over frequency.

VIDEO:

Level: 1 V p-p ± 3 dB, adjustable.
 Response: 15 Hz to 4.2 MHz ± 0.5 dB (standard); ± 1.0 dB (TED in).
 Impedance: 75 ohms, unbalanced.
 Return Loss: ≥ 26 dB.
 Polarity: Black to white, positive going.
 Clamping: > 50 dB dispersal rejection.
 Line-time Waveform Distortion: ≤ 0.5 IRE (p-p).
 Field-time Waveform Distortion: ≤ 0.5 IRE.
 Differential Phase: $< \pm 1.0^\circ$, 10 to 90% APL.
 Differential Gain: $< \pm 2.0\%$, 10 to 90% APL.
 2T Sine?: $< 1.0\%$.
 Threshold (TED in): 82.5 dB-Hz (C/kT).

AUDIO:

Subcarrier Frequency: 6.8 MHz (standard, others optional).
 Frequency Response: 30 Hz to 15kHz ± 0.5 dB.
 Deemphasis: 75 μ s.
 Output Level: Continuously variable, -10 to +15 dBm.
 Impedance: 600 ohms, balanced.
 Harmonic Distortion: $< 0.5\%$.

PHYSICAL:

Operating Temperature: 0° to 50°C.
 Size: 5.25 in. high, 19 in. wide, 18.7 in. behind front panel.
 Power Requirements: 90 watts at 115 Vac.

CONTROLS (Front Panel):

Channel Selector Switch.
 Video Output Level.
 Audio Output Level (up to 4 channels).
 AGC/MGC Selector Switch.
 MGC Level Control.
 Buffered 70 MHz IF Monitor (75 ohm, BNC).
 Audio Baseband Jack.
 Metering Switch: -15 V, Signal Strength, +15 V.
 Monitor Meter.

CONNECTORS (Rear Panel):

RF Input (Type N).
 Composite Video (BNC).
 Video Baseband (Two outputs, BNC).
 Audio Baseband (Terminal blocks, 600 ohm balanced).

Specifications subject to change without notice.



Model 7022 Antenna Position Controller for Motorized Satellite Antennas

- For Harris 6.1, 9, 11 and 13 meter antennas
- Thumbwheel switch preselection of azimuth, elevation and polarization angles for any two satellites. Can be reset for other satellites in seconds
- Simultaneous drive in all three axes
- Digital readout
- Completely interlocked for safety and to prevent equipment damage

Broadcast stations and similar users require antennas that can be used to receive signals from several satellites. For these applications, Harris builds motorized drive antennas in several sizes. For example, special kingpost mounts on 6.1 meter antenna Model 5242 and 9 meter antenna Model 5251 allow a drive rate of one degree per second. Using either of these antennas, a switch from one satellite to another can be made very quickly.

Model 7022 Antenna Position Controller provides simple and convenient control of motorized antennas. Azimuth, elevation and polarization angles can be preset for any two satellites. Using front panel thumbwheel switches, these angles can be reset for additional satellites in seconds. Two-speed drive is provided, to allow rapid drive during the main transition, and reduced speed when the programmed position is approached.

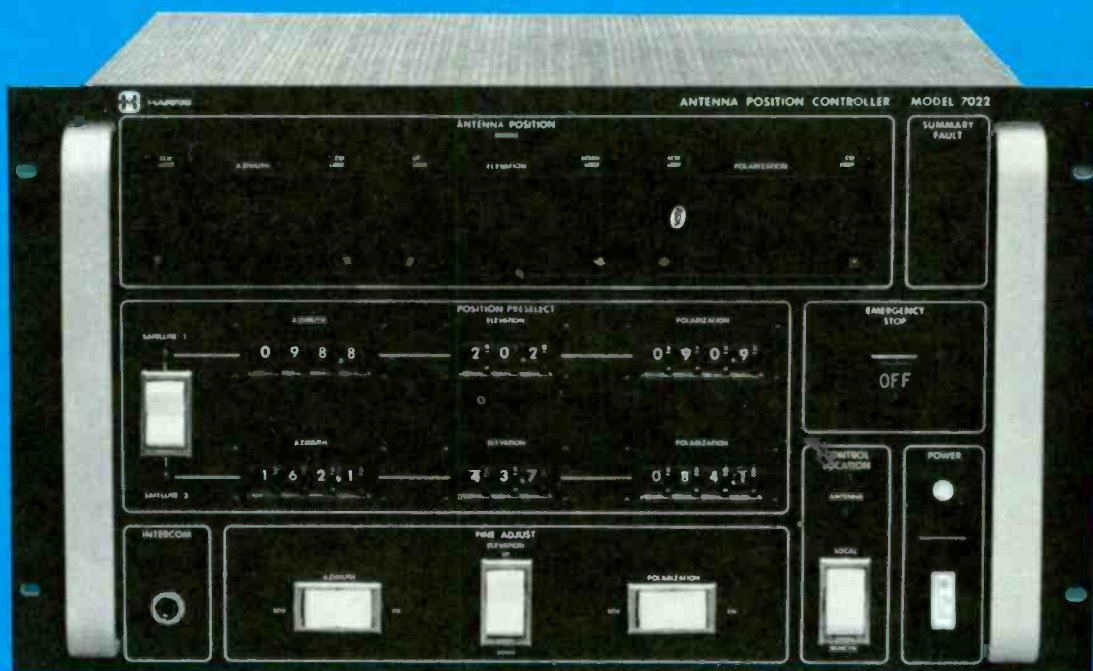

7022 main control unit

Model 7022 includes a main control unit which can be rack mounted up to 750 feet from the antenna, and a drive cabinet mounted at the antenna. Harris provides drive motors and synchros on the antennas, when they are supplied for use with Model 7022 Controller. For operation from a distant studio, connections are provided for remote selection of satellite 1 or 2, and remote fault indication.

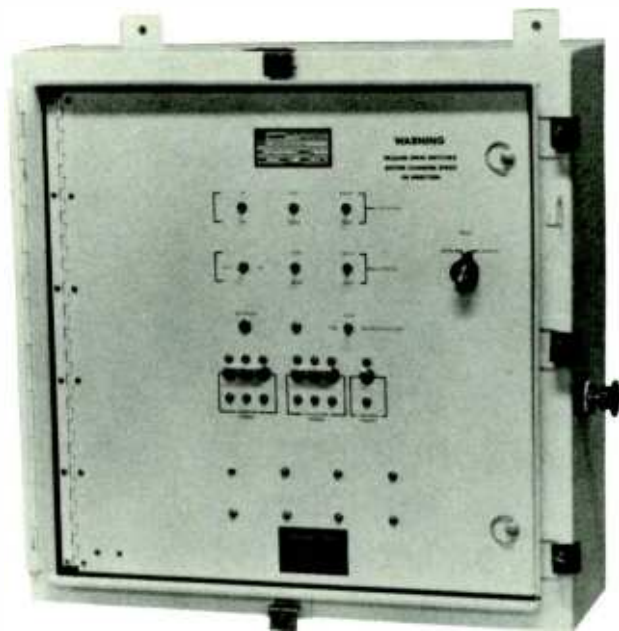

MODEL 7022 SPECIFICATIONS

DRIVE MOTORS: Azimuth and elevation—up to 2 hp, 3 phase, 230 vac
Polarization—0.5 A, 1 phase, 115 vac.

DRIVE SPEED (6.1 and 9 meter):

Azimuth and elevation—1° per second, shifts to 0.5° per second when within 2 degrees of commanded position.

Polarization—1° per second (stepper motor).

NOTE: Drive speeds are determined by mount design and drive motors, not by controller.

CONTROLS AND INDICATORS:

Control Unit—See panel photo.

Readouts—Digital resolvers from synchros; reads to 0.1°, accuracy ±0.3°, repeatability ±0.1°.

Drive Cabinet—Circuit breakers for drive motors. Auto/Manual switch (prevents remote control in manual position). Local motor drive switches for maintenance. Emergency Stop. Intercom jack.

INTERFACE CABLES (no connectors required): One 15-pair, 24 gauge; Three 5-wire 22 gauge special synchro cables (Maximum synchro cable length is 750 feet).

POWER REQUIREMENTS:

Control Unit—115 vac, 50/60 Hz, 1 A; 230 vac 0.5 A optional.

Drive Cabinet and Drive Motors (6.1 and 9 meter)—115 vac, 50/60 Hz, 30 A; 230 vac 15 A optional, 3 phase.

INTERCOM: Wire pair supplied with panel jacks for 2-wire intercom between control unit and antenna.

PHYSICAL:

Control Unit—Panel 19 in. × 10½ in. (48.25 cm × 26.65 cm); Unit depth 19 in. (48.25 cm); Weight: 20 lbs. (9.1 kg).

Drive Cabinet—NEMA 12 enclosure, 24 in. × 24 in. × 8 in. (61 cm × 61 cm × 20.3 cm); Weight: 60 lbs. (27.2 kg).

Specifications subject to change without notice.



HARRIS

HARRIS 9100 FACILITIES CONTROL

For TV Or Radio

- Building block concept allows a wide variety of applications, from complete automatic facilities control (including ATS), to simple remote or local control
- Reduces operating expenses
- Improves transmission quality
- Improves transmission system reliability
- Offers automatic security measures to protect your capital investment
- Allows automatic control of building environment
- Handles time-related functions automatically—tower lights on/off, etc.



YOUR CHOICE OF CRT TERMINAL
OR KEYBOARD ENTRY MODELS



The Harris 9100 Microcomputer Facilities Control Provides Protection...And Significant Savings!

The Harris 9100 is a facilities control system designed to improve your performance, protect your investment and cut your operating costs. The Harris 9100 in its various configurations can provide intelligent remote control; automatic transmitter control; automatic logging; plant protection through intrusion and fire alarms; automatic control of such items as tower lights and building temperature; and automatic exercising of standby equipment.

In short, the Harris 9100 Facilities Control provides surveillance over your transmission system and your physical plant, and offers protection from costly failures wherever they may occur.

The system is composed of a family of micro-computer controlled "building blocks" which determine the configuration, based on a specific application. Whether your need is to monitor and control a single co-located site or to operate up to three remote sites from a single location, the Harris 9100 Facilities Control has the flexibility to meet your requirements. No matter what the size of your operation—whether you're AM, FM or TV—you will find many beneficial applications for the Harris 9100 Facilities Control to help improve your profitability.

WHAT HARRIS 9100 CAN DO FOR YOU

There are three major areas where Harris 9100 Facilities Control can provide significant savings and/or improvements in a station's operation—1) manpower allocation, 2) protection, and 3) equipment performance. Let's take a closer look at each of these for specific examples.

Improved Manpower Allocation. The FCC requires monitoring and adjusting the broadcast transmission to assure compliance with technical standards. In addition, it is imperative that optimum use be made of the equipment while simultaneously protecting it from catastrophic failure. These requirements have been complicated by the increasing use of remote transmitter sites which, while ideal for transmission, are not conducive to manned operation.

The trend in both radio and television has been toward delegation of the transmission system to operations personnel. Remote control equipment has been used increasingly as the only acceptable alternative to a full-time staff at the remote site. This has been a cost-effective approach for management, consistent with the increased stability and reliability of transmitting equipment. However, this approach does not provide the continuous monitoring which can spot trouble about to happen, which can provide trend analysis through careful parameter logging and which can allow operation at peak performance without rule violation.

The first responsibility of operations personnel is usually to the program chain. Even in those stations with a full-time transmitter engineering staff, monitoring the transmitter system may give way to higher priorities of equipment maintenance and repair.

The Harris 9100 Facilities Control meets all existing and currently proposed FCC regulations governing the monitoring, adjustment and remote control of radio and television transmitters. It can offer very valuable assistance to your operators for flawless transmission monitoring, adjustment and logging—freeing them for more effective work elsewhere.

Operation, Equipment and Plant Protection.

The broadcaster is faced with potentially costly mishaps on a daily basis. One such area is violation of FCC rules and the resulting fines, particularly since Congress has dramatically raised the amount of maximum fines. This potential for higher fines has also increased as more stations operate their equipment at the legal maximum power and modulation levels, and operate with lower skilled, often untrained operators.

The transmission system also must meet its own rules in terms of what constitutes safe operation. Careful monitoring together with the proper action and associated alarms, as provided by the Harris 9100 Facilities Control, can help prevent operation outside the legal limits, or costly equipment failures with resulting lost air time.

Additional protection can be provided for the entire physical plant with monitoring and alarms for intrusion or fire which may lead to reduced insurance premiums for these sites.

Improved Performance. Maximizing equipment life and minimizing FCC violations are not the only advantages of Harris 9100 Facilities Control. In an increasing number of markets, large and small, operating equipment at the maximum levels is a key to the successful competition for higher ratings and increased revenues. Even the most stable transmission system needs the attention of the Harris 9100 to operate at peak performance over extended periods of time with minimum equipment problems, and without FCC rule violations.

Another area for improved performance with the Harris 9100 is in trend analysis. Long-range tracking of very accurate readings helps locate problem areas in the transmission system and pinpoint areas for improvement.

HOW HARRIS 9100 FACILITIES CONTROL IS USED

Remote Control. The Harris 9100 Facilities Control opens a new dimension in remote control, providing intelligent surveillance and decision-making. Channels are automatically scanned and compared with pre-programmed limits; and alarms are initiated or corrective action taken, as appropriate. Power can be computed using the indirect method of power determination and the Harris 9100 can serve either as an efficiency monitor or as the primary means of power control.

Automatic logging of all parameters can be performed on a regular basis, eliminating periodic interruptions of station personnel. Also, the logger fully records out-of-limits conditions when they occur.

Time-initiated switching may be employed for power levels, changing control limits, checking tower lights, and other time-oriented functions.

Automated Transmission System (ATS).
The Harris 9160 and 9161 Automatic Control

Unit (ACU) provides for ATS operation with its power and modulation control, yielding additional benefits to management. Relaxed operator restrictions will give greater flexibility in the selection of staff and duties; the FCC requirement for a person to be present for monitoring can now easily be met by utilizing a receptionist, switchboard operator or guard. Under existing and currently proposed ATS rules, there will be a reduction in requirements for routine inspections, meter readings and logging requirements. And there will be much less anxiety concerning the reliability of switching power modes in AM stations, very often a problem where "combo" operators are employed.

To sum it up, the Harris 9100, operating under ATS rules, will provide cost savings considerably beyond those provided by remote control, through more efficient use of manpower.

Facilities Control. The Harris 9100 Facilities Control is a true systems approach to the transmission system and related physical plant. Up to three remote sites can be controlled from a single common control unit at the studio. In addition to control of the transmission system, related functions can be surveyed and controlled. Heating, air conditioning and ventilation equipment can be monitored. Backup equipment can be exercised and performance logged, all on an automatic basis. And temperature sensors and intrusion alarms can be constantly on guard for plant protection. By combining the monitoring and control of all functions, the Harris 9100 Facilities Control will profitably produce greater consistency, precision and reliability of operation than is obtainable with existing manually operated equipment. In addition, The Harris 9100 will allow maximum operation of the transmission system to provide the most competitive broadcast signal in your market.

The Harris 9100 Facilities Control design is based on over half-a-century of experience by Harris in the broadcast equipment field—and the quality is backed by the most experienced service organization in the industry.



Studio Unit (9120)



Transmitter Unit (9130)



Automatic Control Unit (9160)

Harris 9100 Facilities Control Components

Studio Unit (9120). Location: studio facility. Function: communicates with the Transmitter Unit (9130) or the Automatic Control Unit (9160) to provide monitoring and control of the transmitter facility.

Transmitter Unit (9130). Location: transmitter site. Function: provides remote control of the transmission facility when used with a Studio Unit (9120) or an Automatic Control Unit (9160). Allows remote control from a studio facility or from another transmitter facility. Alternate function: provides local control of the transmission facility.

Automatic Control Unit (9160). Location: transmitter or studio site. Function: provides automatic facility control—i.e., intelligent remote or automatic control of transmitter (ATS), building environment, security measures, etc.

CRT Terminal Models



Studio Unit (9121)



Automatic Control Unit (9161)



Studio Unit (9121). Location: studio facility. Function: communicates with the Automatic Control Unit (9161) to provide monitoring and control of the transmitter facility.

Automatic Control Unit (9161). Location: transmitter or studio site. Function: provides automatic facility control—i.e., intelligent remote or automatic control of transmitter (ATS), building environment, security measures, etc.

Options



Monitor and Alarm Panel

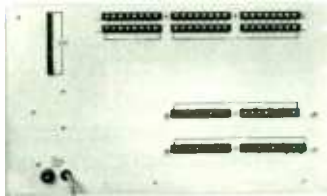

Channel Expansion Panel

Loggers



Extel



TI-820

Loggers. Extel (300 baud), for 9120, 9130 or 9160; Texas Instruments TI-820 (9600 baud), required on 9121 and 9161. Optional on other models.

Monitor and Alarm Panel. Used in conjunction with the Automatic Control Unit (9160), provides minimal monitoring and control in compliance with FCC ATS rules for monitor and alarm points.

Channel Expansion Panel. Offers additional channels for the Transmitter Unit (9130) and Automatic Control Units (9160 and 9161). Each panel adds 8 telemetry, 16 status and 16 command functions. Up to 7 Channel Expansion Panels may be added to each 9130, 9160 and 9161 unit.

Multi-Site Module (not shown). Allows a Studio, Transmitter or Automatic Control Unit to communicate with up to three remote sites.

9100 Facilities Control Information

	9120	9130	9160	9121	9161		9120	9130	9160	9121	9161
Keyboard or CRT Terminal I/O	KBD	KBD	KBD	CRT	CRT	Maximum status input display per display group	16	16	16	128	128
Communicates with remote sites, display and control identical to unit at remote site	XX	XX	XX	XX	XX	User-defined CRT displays, messages, logs and log headings	—	—	—	—	XX
User-assignable time functions	—	5	64	—	64	DCA type channel squaring	—	XX	XX	—	XX
Limits monitoring and executive action, number of analog channels	—	5	all	—	all	Calculation channels	—	—	3*	—	6
Status monitoring and alarm	—	all	all	—	all	Can interface with MONITOR and ALARM PANEL (used for ATS only)	no	no	opt.	no	no
Status monitoring/alarm and executive action channels	—	—	all	—	all	Multi-site module	opt.	opt.	opt.	opt.	opt.
15-step series functions	—	—	4	—	4	Log printer (opt.) minimum CPS	30	30	30	150	150
5-step mini-series functions	—	—	—	—	6	CHANNEL EXPANSION PANELS, units included + maximum (opt.) add-on	—	1+7	1+7	—	1+7
Modulation level control	—	—	XX	—	XX	Analog input channels per CHANNEL EXPANSION PANEL (CEP)	—	8	8	—	8
Separate data bases	—	—	3	—	3	Number of control relays with 5A-120VAC contacts per CEP	—	16	16	—	16
Separate partitions	—	—	4	—	6	Number of (opto-isolated) status input channels per CEP	—	16	16	—	16
Logging capability	opt.	XX	XX	XX	XX	Automatic system restoration after power failure and return	—	—	XX	—	XX
Real-time clock—hrs/min/sec	1 day	1 day	1 day	7 day	7 day	Auto link switching capability	—	XX	XX	—	XX
CRT entry of scaling factors	—	—	—	—	XX	Battery backup for user program	opt.	opt.	opt.	opt.	opt.
Momentary or latching relay action at mode entry	—	XX	XX	—	—						
Assignable momentary or latching relay action via CRT terminal	—	—	—	—	XX						

*1 calculation channel per data base

Typical 9100 Facilities Control Systems

For ATS OPERATION

- A. 9160 Automatic Control Unit + (N) Channel Expansion Panels
9100 Monitor and Alarm Panel
9100 Battery Backup for 9160
- B. 9161 Automatic Control Unit/CRT + (N) Channel Expansion Panels
9121 Studio Control Unit/CRT I/O Terminal
9100 Battery Backup for 9161 and 9121 (2)

For INTELLIGENT REMOTE CONTROL

- A. 9130 Transmitter Control Unit + (N) Channel Expansion Panels
9120 Studio Control Unit (Keyboard I/O)
9100 Logging Electronics Package

Extel 30 CPS Log Printer
9100 Battery Backup for 9130 and 9120 (2)

- B. 9160 Automatic Control Unit + (N) Channel Expansion Panels
9120 Studio Control Unit (Keyboard I/O)
9100 Logging Electronics Package
Extel 30 CPS Log Printer
Battery Backup for 9160 and 9120 (2)

- C. 9161 Automatic Control Unit/CRT + (N) Channel Expansion Panels
9121 Studio Control Unit/CRT I/O Terminal
TI-820 150 CPS Log Printer
9100 Battery Backup for 9161 and 9121 (2)

Glossary

TIME FUNCTIONS	Will execute user-defined action as a function of time entered: Hourly if only minutes and seconds entered, daily if hours added, and weekly (9161 only) if day of week added to entry.
LIMITS MONITORING	System monitoring of all analog input channels for user-defined UPPER FAILURE, UPPER ALARM, LOWER ALARM and LOWER FAILURE limits. System may be programmed to take corrective action, initiate alarms and/or take appropriate failure limit action.
STATUS MONITORING	System monitoring of all status inputs for user-defined conditions. Alarms and/or actions (9160 and 9161 only) may be executed if status is other than normal.
SERIES FUNCTIONS	<p>There are four 15-step and six 5-step (9161 only) series functions. Each step consists of: (A) CLOCK DELAY TIMEOUT (0-255 seconds), (B) CONTROL FUNCTION ACTION, (C) START SECOND CLOCK TIMER (0-255 seconds), (D) STATUS INPUT NUMBER, (E) STATUS INPUT CONDITION.</p> <p>Upon execution: First timer times out, control action initiated, second timer is started, designated status input is checked for a match with defined input condition; if a match, the next step is executed—if no match is made before second timer times out, an alarm is initiated and sequence stopped (on the 9161 a jump to another step can be programmed).</p>
AURAL MODULATION LEVEL CONTROL	Will automatically maintain highest possible level of modulation (stereo audio, or composite) and still remain legal. Provides ± 6 dB gain in 256 steps of approximately .05 dB/step in 600/600 ohm circuits. When a 5 ms burst of overmodulation (FCC defined hit) occurs, the level is dropped .05 dB each time. If no hits occur within 60 seconds, the level is increased a .05 dB step. Different rates of level adjustment are provided under certain other conditions for optimum level control. The system requires an audio feed from the station's modulation monitor.
SEPARATE DATA BASES	Three data bases provided in 9160 and 9161 to allow different limits to be set for pre-day, day and night parameters—or, any other condition that requires changed parameters.
SEPARATE PARTITIONS	Partitions provide the capability of separating or dividing the system monitoring among independent entities (4 for 9160, 6 for 9161) such as main and alternate transmitters, etc. Partitions may be enabled by series functions, time functions or manual actuation.
LOGGING CAPABILITY	A system log can be printed at the transmitter, at the studio or control point, or in both locations. A 9130 and 9160 system log consists of all analog channels, all status inputs and all special control functions. A 9161 systems log can be user-defined.
REAL TIME CLOCK	Provides 24 hour clock display of hours, minutes and seconds (plus day of week in 9121/9161). Used in logging entries, and in execution of time functions as described above.
SCALING FACTORS	CEP channel calibration controls may be used for precise system readings without scaling. Approximate settings of the calibration controls ($\pm 50\%$ preferred), plus the CRT keyboard entry of the appropriate scaling factor (calculated) will result in automatic scaling of all subsequent readings of that channel. This allows simplified calibration of the 9161 system.
MOMENTARY OR LATCHING RELAY ACTION	Individual 9130 and 9160 CEP relays may be programmed for latched on (normally closed) operation, or left in the momentary state with normally open contacts. They may be latched on or pulsed in the series functions, as well as in other appropriate modes of entry/operation.
ASSIGNABLE MOMENTARY OR LATCHING RELAY ACTION VIA CRT	The 9161 Control Function Edit Mode enables the user-assignment of individual CEP relays for latched on (normally closed), pulsed or momentary (normally open) operation. Non-assigned relays are momentary. Assigned relays remain in the programmed state while user memory is sustained, unless reprogrammed.
MAXIMUM STATUS INPUT DISPLAY PER DISPLAY GROUP	9120/9130/9160 displays have 16 status positions that can be selected in 8 groups to show any of the 128 status inputs. Keyboard entry of a status input number in group 2 (017 thru 032) will shift the entire group to that set of 16 status positions, the same for group 3 (033 thru 048), etc. All 128 status inputs appear on the 9121/9161 CRT screen simultaneously.
USER-DEFINED CRT DISPLAYS, MESSAGES, LOGS AND LOG HEADINGS	Special control functions in the 9161 provide access for entering labels, messages (instructions to the operator, etc.), log definitions, and log headings of up to four 80-character lines. The analog and status input channels can be assigned to one of the 8 vertical columns in the log printout.
DCA TYPE CHANNEL SQUARING	Any channel in the system may be used for a DCA channel. The 9100 system does not require any external DCA's, and because values are calculated (.05% resolution) they do not drift.
CALCULATION CHANNELS	Entry of 2 analog input channels plus an efficiency factor (user-assigned) provides readings, such as indirect power. Different sets of limits, or even completely different sets of input channels and efficiency factors, may be entered in each of the 3 data bases to provide up to 3 independent calculation channels in the 9160. The 9161 has 6 independent calculation channels that accept only limits changes per data base.
MULTI-SITE MODULE	This is required in 9120/9121/9130/9160/9161 units used as the studio control unit in systems with 2 or 3 remote 9130/9160/9161 transmitter control units. Multi-Site Modules are not required in systems with one co-located and one remote transmitter control unit, but are needed with one co-located and 2 or 3 remote transmitters.

Harris 9100 Facilities Control Specifications

ELECTRICAL CHARACTERISTICS

Communications Channels (8dB max. insertion loss)

Data Communication: 2 wire full duplex, 600 ohms
4 wire duplex 600 ohms

Type: FSK data

Mark 2225Hz)

High band

Space 2025 Hz)

Mark 1270 Hz)

Low band

Space 1070 Hz)

Rate: 300 baud

Send/Receive Bands: Switch selectable

TELEMETRY

Number Channels: 8 to 64 in increments of 8

Impedance: Balanced 530K ohms

Metering: Digital ± 1999 max reading and programmable decimal point

Rated Input: ± 1.0 volts minimum for 1000 reading on meter

Accuracy: 0.5% at full scale

Resolution: 1 mV

STATUS INPUTS: 16 to 128 in increments of 16

Type: Opto-isolated

Input Level: 5 to 12 volts

Impedance: 360 ohms above 2 volts threshold

COMMAND OUTPUTS: 16 to 128 in increments of 16

Type: Normally dry open contacts

Rating: 5A @ 115 VAC/2.5A @ 230 VAC resistive load. For other ratings different relays may be used.

Failsafe: The failsafe relay is the highest operating channel relay in the system.

AUDIO MODULATION CONTROL INPUT- Stereo

Impedance: 600 ohms $\pm 2\%$

Maximum Input Level: 24 dBm

Output: Stereo

Impedance: 66 ohms for driving 600 line

Level: 22 dBm (into 600 ohms)

THD: 0.1% dB 30 Hz to 15 KHz

WIDEBAND INPUT IMPEDANCE: 10K (50 ohms strappable)

Output Impedance: 150 ohm $\pm 5\%$

S/N: 66 dB (full BW ref. 1 volt into 1500 ohms)

Stereo Separation: 43 dB

THD: 0.1% 30 Hz to 75 kHz

Response: ± 0.2 dB 30 Hz to 75 kHz

MODULATION MONITOR

Input Impedance: 5K (50 ohm strappable)

Level: BNC: 10 volts P-P maximum

Detector Response: Overshoot $\leq 1\%$

S/N: 55 dB (ref. to 5 volt P-P input)

AUDIO INPUTS

Input Impedance: 10K (600 or 300 ohm strappable)

Level: 10 volts P-P maximum

MECHANICAL AND ENVIRONMENTAL CHARACTERISTICS (All Models)

Temperature: 0°C to 50°C

Relative Humidity: 5 to 95% non-condensing

Altitude: 0 to 10,000 feet

DIMENSIONS AND POWER

CEP

Power: 117 VAC $\pm 10\%$, 50/60 Hz, 40 watts or 235 VAC $\pm 10\%$

Dimensions: 10½" high \times 2" deep \times 19" wide, 17 pounds

MAIN FRAME

Power: 117 VAC $\pm 10\%$, 50/60 Hz (150 watts for 9160), (110 watts for 9130), (75 watts for 9120)

Dimensions: 10½" high \times 17" deep \times 19" wide

Weight: 46 pounds (9160)

38 pounds (9130)

36 pounds (9120)

Specifications subject to change without notice.

ORDERING INFORMATION

9161 Automatic Control Unit	994-8494-001
9121 Studio Control Unit	994-8493-001
9160 Automatic Control Unit	994-8232-001
9120 Studio Control Unit	994-8233-001
9130 Remote Control Unit	994-8234-001
Channel Expansion panel for 9130, 9160 and 9161 Control Units	994-8240-001
9100 Monitor and Alarm Panel for 9160 Automatic Control Unit	994-8244-001
Extel Log Printer (9120, 9130, 9160)	749-0051-000
Texas Instruments TI-820 Log Printer	749-0072-000
9100 Multi-Site Module	994-8241-001



HARRIS

9165 Advanced Earth Station Facilities Controller

- Can be used for on-site, remote site, and multi-site applications
- Programmable switching from transponder to transponder and satellite to satellite for up to 525 signal paths
- Controls 6.1, 9, or 11 meter Harris antennas
- Signal switching can be pre-programmed for up to one week
- System will handle up to 8 frequency agile Harris video receivers, up to 4 frequency agile Harris video exciters, and up to 4 tunable HPAs (High Power Amplifiers)

For the satellite broadcaster who desires maximum control, flexibility and documentation in his operation, the Harris 9165 Advanced Earth Station Facilities Controller is an ideal choice.

BUILT-IN VERSATILITY

While the standard 9100 Automatic Control Units contain up to eight CEPs (Channel Expansion Panels), the 9165 Ad-

vanced Earth Station Facilities Controller replaces one CEP with an ACP (Antenna Control Panel). The remaining CEPs may be assigned any of various "housekeeping" and monitoring duties. Additionally, the 9125 Studio Control Unit accesses all parameters remotely via microwave or telco data circuits.

COMMANDING DEGREE OF CONTROL

The Antenna Control Panel in the Harris 9165 is designed to interface with Harris 6.1, 9, or 11 meter satellite antennas, providing remote control of azimuth, elevation and polarization. Most remarkable is the software approach which allows a 24-entry file format accessing antenna position, frequency tuning for up to eight receivers, four exciters and four HPAs (High Power Amplifiers). This data can be retrieved on manual command or by time clock function. For a further degree of operating latitude, all individual units may be addressed separately and independently. All automatic functions found in the Harris 9100 Facilities Control (limits monitoring, series functions, partitioning, etc.) apply here as well.

SPECIFICATIONS

FOR MAIN FRAME AND CEP, SPECIFICATIONS ARE THE SAME AS FOR THE 9100 FACILITIES CONTROL.

Antenna Control Panel: Accommodates Harris SSL (Studio to Satellite Link) antenna system utilizing the 7022 Control Electronics Package.

Also accommodates 8 Harris 6521 or 6522 frequency agile receivers, 4 Harris frequency agile exciters and 4 Varian VZJ-2700 klystron HPAs (High Power Amplifiers).

Power: 117 VAC ± 10%, 50 watts

Dimensions

Height: 14 inches (35.5 cm)

Width: 19 inches (48.5 cm) rear rack mounted

Depth: 4 inches (10.2 cm)

SPECIFICATIONS SUBJECT TO CHANGE WITHOUT NOTICE

ORDERING INFORMATION

9165 Advanced Earth Station
 Facilities Controller 994-8681-001
 9125 Earth Station Studio Controller Unit 994-8688-001



One of 24 CRT displays available on command, which gives detailed status information on earth satellite parameters.



9100 Facilities Controller Disk Memory Option

- Reduces operational display time
- Changeable diskettes provide non-volatile memory for user flexibility and file security
- Dual disk drives increase system reliability and provide user with file copy capability

The addition of the Floppy Disk Drive Memory Option provides some unique system enhancements. Greater software security results from having a non-volatile memory in the form of diskettes which can be reproduced for storage. The time required to receive operational displays is significant for large information displays.

TIMELY CONTROL AND MONITORING

The Harris 9100 CRT based Facilities Control System engages in a continual data exchange between sites to provide up-to-the-minute monitoring and control. This surveillance may include control of the transmitter facility, building environment, security measurers, etc.

The 9100 Disk Memory Option is available to enhance the standard CRT based facilities controller with large-scale non-volatile memory. This protects all user entered programming, including multiple site information. In addition, the operation speed of the 9100 System is improved via accelerated display time of user entered programming.

The 9100 Disk memory operates as an option to all Harris CRT based Facilities Control systems.

SPECIFICATIONS

DUAL FLOPPY DISK DRIVE SYSTEM

Height: 10 inches (25.4 cm)

Width: 19 inches (48.5 cm) rack mount

Depth: 13.5 inches (34.3 cm)

Weight: 18.5 lbs. (8 kg)

Spindle Speed: 300 RPM ($\pm 3\%$)

Sectoring, GCR Encoding: 5¼ inch soft sectored

Density (Inner track): 6,380 bits/inch

ENVIRONMENTAL*

Temperature Range: 32°F to 131°F—0°C to 55°C (operating)

Relative Humidity: 5% to 95% non-condensing (operating)

Altitude: To 10,000 feet (3048 meters)

* Typically located in a controlled studio environment, which is dust and contaminant free.

SPECIFICATIONS SUBJECT TO CHANGE WITHOUT NOTICE

ORDERING INFORMATION

9100 Disk Memory Option 994-8675-001

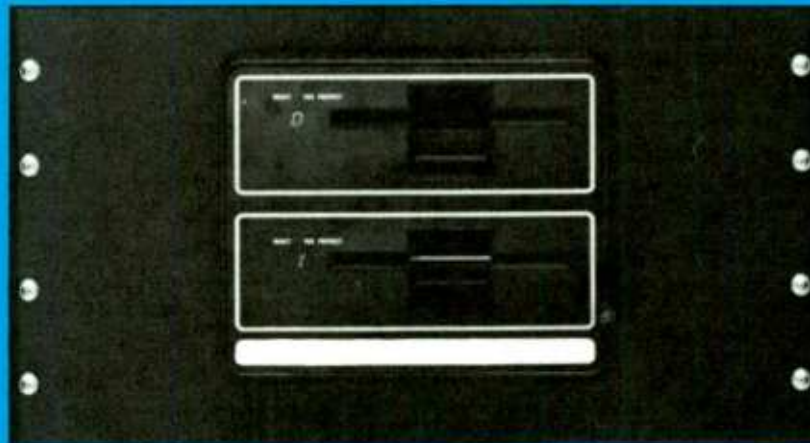



HARRIS

THE HARRIS 9000 PROGRAM CONTROL SERIES

• Three distinct systems available, offering the broadcaster a complete selection to meet his particular requirements • MULTI-FILE™ Program Memory saves you time...and money • Easy-to-understand video display of current system status • Conversational messages • No special skills required to operate system • Live-assist features and ease of operation meet the needs of today's fast-paced combo operator • Advanced micro-computer design • Operationally and environmentally proven... hundreds of Harris' systems in field use.



The Harris 9000 Program

The purpose of radio program control equipment is to maximize station profits through greater operating efficiency and through the presentation of a more saleable program product. That's pretty basic, but that's what it's all about...saving time...improving your product...increasing your profits.

That's what the Harris 9000 Program Control is all about, too. It has been designed to give you the best tool available to increase the efficiency and effectiveness of your staff, while providing the opportunity to improve your sound—whatever your format may be.

As the originator of micro-computer program automation, Harris has drawn on its years of experience, and taken the next step forward to give you more flexible, more convenient, more reliable, and easier to operate systems than any available before. Harris 9000 systems will handle any format flawlessly, yet are so easy to understand, and so easy to program that even the most non-technical person in your station will readily see how they work and appreciate their help.

With many exclusives, from live-assist features to the truly advanced MULTI-FILE™ Program Memory, the Harris 9000 Series is definitely the most advanced concept in program automation, and the best there is at its job—helping you improve your results, on the air and on the bottom line.

UNLIMITED FLEXIBILITY TO HANDLE ANY FORMAT....

With the wide variety of program formats that are on the air today, a system must have great versatility if it is to be able to handle any one of them. Harris' 9000 systems have that versatility. No programming is too complicated—or too simple. They will faultlessly handle everything from fast-paced “lots-of-music, lots-of-talk” programming to a more simple sequence of reel-to-reel events integrated with commercials at the proper times. In addition, the Harris 9000 enables management to achieve its goal of minimizing the time and errors associated with entering commercials and other schedule changes.

EFFICIENCY AT EVERY STAGE....

The Harris 9000 aggressively pursues maximum efficiency at every stage of station operation. The video terminal provides necessary information—very complete yet very simple—for schedule entry and review. Even during editing, a status display informs the operator of the on-air situation, alerting him to possible problems. Conversational messages provide easy-to-understand prompting regarding the nature of errors. The keyboard layout, developed from Harris' experience in hundreds of installations, is aimed at fast and reliable scheduling.

SIMPLIFIED SCHEDULE ENTRY WITH MULTI-FILE PROGRAM MEMORY....

The need to separate commercials from repetitive format elements was partially satisfied with the use of sub-routines, a concept developed by Harris and now widely copied throughout the industry. With the MULTI-FILE Program Memory, Harris' 9000 has vastly improved on a good idea, providing a real solution to an error-prone, time-consuming problem.

Commercial schedules, music rotations, repetitive format elements and special programs are all independent schedules which must be integrated to create the broadcast day. MULTI-FILE Program Memory provides independent files for these schedules, eliminating the need to refer to unrelated material. Traffic, for instance, no longer needs to know where to go after a commercial cluster. Traffic keeps the commercial file, the music director keeps the playlist file, etc. This is a real time-saver.

The Harris 9000 with MULTI-FILE Program Memory keeps things simple by integrating these various schedule files, according to plan and always on time. The operator can highlight on the video screen the look-ahead display of entries from any particular file; in addition, a bar graph can be displayed, distinctly illustrating the integration of upcoming schedule files. The innovative use of graphics

Control

MORE VERSATILE, MORE EFFICIENT THAN ANYTHING YOU'VE SEEN BEFORE

in the Harris 9000 is not only of great assistance to the operator, but minimizes effort in the area of operator training.

IMPECCABLE EXECUTION...

Today's competitive operation can't afford to waste time deciding whether or not a format change is possible. The Harris 9000 Program Control knows that any format is possible, and concentrates on impeccable execution. "Tighter playlist control...more consistent air sound...increased ratings" are broadcaster

comments that are frequently made about Harris' program control equipment.

Live or automated operation is no longer the issue when the end result is a significant advantage in ratings and revenues. The Harris 9000 provides multiple overlaps, dependable voice-track synchronization, plus solid support for the fast-paced live announcer.

Live-assist means never having to keep a program log, stack carts or cue records. A countdown timer, complete with a ten-second warning, helps maintain a tight sound. Insertion of unscheduled material is easy. This is live-assist that really aids your on-air talent and encourages more creative performance.

The 9000 Series Control Electronics

At right is a typical system for use with a program service. Music is on reel-to-reel. Commercials (and other cartridge material) are in the instant access Instacart (5) and the random access Go-Carts (6 & 7). When time-announce is used, deck 14 has even numbered minutes and deck 15 has odd numbered minutes. The system electronics require only half of a standard rack for mounting.

A. The computer mainframe includes the monitor panel and control electronics.

B. The solid-state Audio Switcher houses source modules, dual silence sensors, program amplifiers, faders and 25 Hz filters.

C. Computer-grade power supply.

D. Dual flexible-disk drives for increased memory storage capabilities (9002 and 9003).

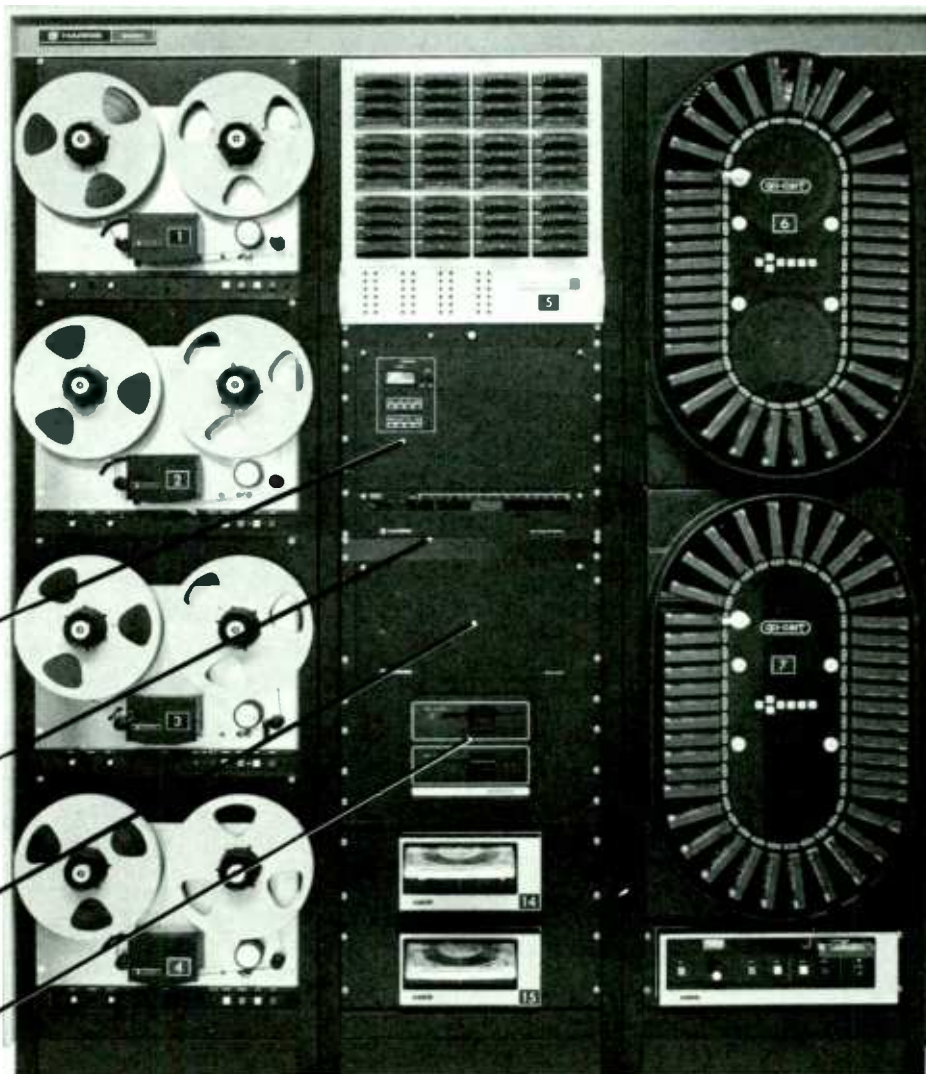

The 9000 Series Control Terminal

Programming and operating instructions are communicated to the system from a terminal that may be located up to 150 feet from the system electronics. The terminal provides continuous video display of various operational functions, and is also used for editing purposes.

Upper area shows on-air status, real time, and the next scheduled event.

Lower area shows, in the various operational displays, a list of upcoming schedule entries. In the editing modes, this serves as a "work area".

A full typewriter keyboard is provided for entering log messages for encoding. In the 9003, the keyboard is also used for titles and for live copy insertions.

In the 9003, up to 3 lines may be used for bulletins or other copy for live insertions. For instance, this copy may be typed on the news room terminal and will appear on the studio terminal video display.

The Mode Control Keys are used to determine what data is to be entered (scheduling, set clock, log encoding, etc.). Manual operation keys are used for remote control (START, STOP, FADE, etc.).

The Data Entry Keyboard is used for entering instructions. It includes dedicated function keys to eliminate typing frequently used instructions (PLAY, INTRO, LINK, etc.).

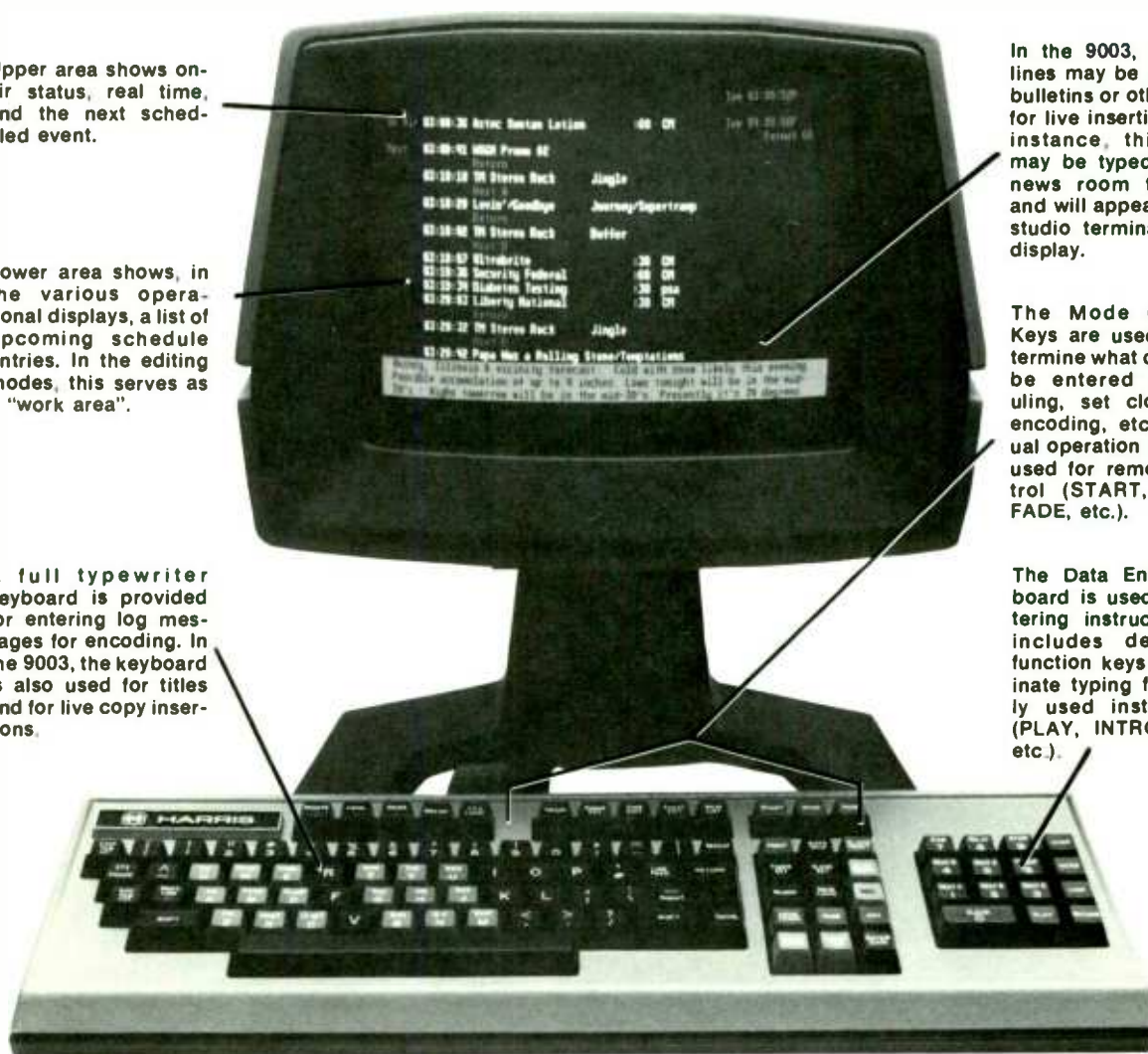

YOUR CHOICE OF SYSTEMS TO MEET YOUR PARTICULAR REQUIREMENTS. The Harris 9000 Series is composed of three distinct systems, each showing a progressive increase in programming capability. The 9001 is a basic program control system which can be used for any automation requirement. It uses a single video terminal, and has a 1,999-event memory, which is expandable up to 9,999 events. The 9002 fills all program control requirements, plus has the ability to interface with an external business system, and can be programmed from totally independent terminals. It has a 1,999-event memory, expandable up to 9,999 events. The

9003 handles even the most sophisticated format faultlessly.

The Harris 9000 Series has been designed to expand as your needs expand. All 9000 Series models can easily be upgraded in the field to a higher numbered model.

THE HARRIS 9001. The 9001 has the full mainframe, audio switcher and heavy-duty power supply already in use in hundreds of installations worldwide. The 1,999-event memory (expandable to 9,999 events) and the 7-day clock allow you to program for a weekend or an entire week ahead. The simple keyboard and plain-text programming assure

mastery of system operation by most station personnel in less than a day. Dual-intensity video allows highlighting of the schedule items chosen by the operator. The types of highlighted entries could be commercial clusters, music sets, contest/promos—any file from the MULTI-FILE™ Program Memory.

Among the many other important 9001 features are: automatic power failure restart, time announce control, network join, ready sensing to prevent dead air, remote control and countdown clock for live-assist, bulletin insertion, “coffee pot” function relays, and MULTI-FILE Program Memory.

THE HARRIS 9002. In addition to the many features of the 9001, the 9002 includes dual flexible-disk drives to increase the memory capability and to provide a permanent memory storage medium.

Another key innovation is the ability of the 9002 to support totally independent terminals. Using MULTI-FILE Program Memory, the traffic director and program director can have their own files in the program memory. Now they can both edit their respective areas of event memory simultaneously! And, while this is happening, data can be received or transmitted to an external business system using the port provided for this purpose.

THE HARRIS 9003. The Harris 9003 has revolutionized the role of program control in radio broadcasting by integrating the program system into the planning process—extending the benefits of program control beyond the operations level to everyone concerned with the on-air product.

The Traffic Director can enter on the CRT display a new commercial order. He selects an account number, enters time, anticipated running time and the desired description, which will also appear on the display (and

optionally on the log). The Traffic Director may also specify one of several live copy tags to be associated with the announcement, and that tag will also appear on the control room terminal. All further references can then be made using the account number.

With the plain-text title display feature, the music director no longer has to wonder if the system will air the recurrent record he wants following a commercial break. With Harris 9003 in charge of a random access music library, it is now possible to specify the names of the music selections. Instead of a “Play 05-27” indication, an operator will see that the scheduled selection is “Sara by Fleetwood Mac”, along with other information, on the same line, such as intro/running time and chart position.

As more stations seek to better localize their syndicated programming, there is a need for periods of live programming; this may be for drive time or news blocks. In any case, the Harris 9003 is ideal for the live operator. The display shows the name of a song or commercial that is on the air, plus the names and starting times of upcoming scheduled events.

The system software is contained on the disk. In the unlikely event of disk failure, the system defaults to programmed Read-Only Memory (EPROM) chips located on the single 8080 CPU board; it would then operate similarly to the Harris 9002.

Going beyond the traditional role of the program system, the Harris 9003 brings significant benefits to the broadcaster—cost reduction due to reduced workload at the planning stage; improved on-air performance from scheduling flexibility; reduction in lost revenue due to scheduling errors; and improved operator performance due to easier system operation.

MAJOR SYSTEM CAPABILITIES

Harris 9000 Series Model	Standard No. of Days of Operation (Walkaway)	Stand. No. of Days with Optional Memory Expansion	Interfaces with Business Automation	Countdown Clock	Independent Editing/Prog. Terminals	Logging	Plain-Text Programming	Plain-Text Title Display	Live Copy Display
9001	3*	15*	Optional	Program-mable	Yes (Optional)	Optional	Yes	No	No
9002	3-15*	15-31*	Yes	Program-mable	Yes (Optional)	Included	Yes	No	No
9003	31**	Not Applicable	Yes	Auto-matic	Yes (Optional)	Included	Yes	Yes	Yes

*Based on average of 50 events per hour **Based on average of 110 events per hour.
SPECIFICATIONS SUBJECT TO CHANGE WITHOUT NOTICE.

STANDARD FEATURES IN ALL HARRIS 9000 SYSTEMS...

- Video editing and display
- MULTI-FILE™ Program Memory
- Jock-assist countdown clock with 10-second warning
- Automatic power failure restart
- Built-in time announce control
- Interfaces to all popular random access machines
- Ready sensing to prevent dead air
- Crystal-controlled 7-day clock
- Simple one-time bulletin insertion
- Operator "error sensing"
- Automatic voice track control
- Programmable fade-under for talk-over
- Software logic — your safeguard against future obsolescence
- Front panel access to test points and adjustments
- Full function monitoring and audition
- Optional logging, which provides discrepancy diagnostics
- 25 Hz detection included for all reel-to-reel sources
- Ready for most syndicated programming services
- Four "coffee pot" function relays included
- Micro-computer versatility
- Complete system remote control
- Dual silence sensors
- Stereo and sum-channel mono outputs
- Emergency back-up operation panel

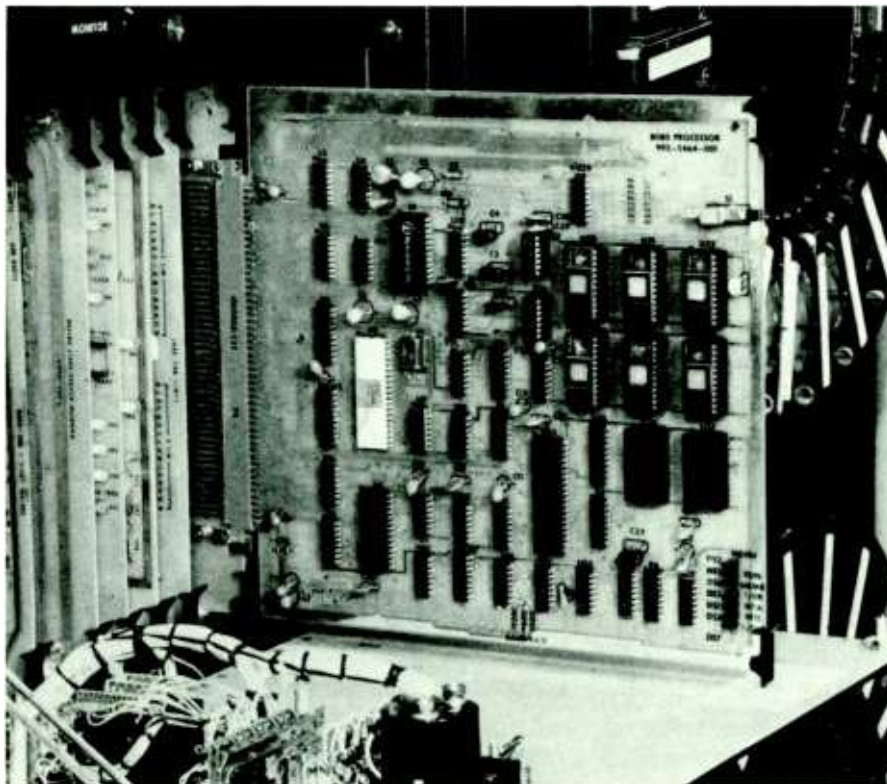

All processing is accomplished by a single CPU board. Harris 9000 Series circuit boards are designed and tested by computer-controlled equipment.

A COMPLETE LINE...

The Harris 9000 Series has been designed for easy plug-in expansion to accommodate the growth you expect for your station. Starting with the Harris 9001, which is the basic control system, on through the Harris 9002 and 9003, you have a choice of models, depending on your initial application requirements. Each model is easily upgraded in the field to any higher model number. The 9001 features the same mainframe, audio switcher and heavy-duty power supply already in use in hundreds of installations worldwide. The 9002 adds dual-drive flexible-disk storage, independent-terminal circuitry, and business system interface hardware. The Harris 9003 integrates the program system into the planning process to extend the benefits of program automation to

the management level. Additional sources may be added to all models, as may the sophisticated Harris logging system.

BUILT AND BACKED TO PROVIDE LONG-TERM VALUE....

The Harris 9000 Program Control is built using the latest computer-assisted techniques to assure outstanding reliability in the field. The quality of Harris' micro-computer program control is backed by the most experienced service organization in the industry, and is proven with the largest users' group in the country. Benefit from the experience of others. It all adds up to make the Harris 9000 Program Control a very secure investment for your station.

For a complete evaluation of your requirements, and a system proposal, please contact your Harris Radio District Sales Manager, or Harris in Quincy, Illinois (217/222-8200).



HARRIS

AUTOTRON STAR

Radio's Mini-Computer In-House Business System

- Sales
- Traffic
- Accounts Receivable
- General Ledger
- Accounts Payable
- Payroll
- Word Processing/Office Automation
- Music Library
- Background Music Billing
- Automation Interfaces



The Harris AUTOTRON STAR System is a computerized traffic and business system designed specifically for radio broadcast operation.

The AUTOTRON STAR System is the ideal choice for radio station operators and groups who need a complete end-to-end business system. AUTOTRON STAR's effectiveness evolves from the sales order entry. The sales order, once entered, provides all the information necessary for subsequent scheduling (including protections and rotations), logging, and finally, billing and affidavits. Statements are produced showing charges by invoice date. And when combined with AUTOTRON STAR Plus, a full bookkeeping system including payroll, general ledger, and accounts payable, the AUTOTRON STAR System is a comprehensive, complete solution to the problem of management control of a broadcast facility.

HARRIS AUTOTRON STAR...

Radio's total business automation system



OPTIMIZATION THROUGH FLEXIBILITY

The AUTOTRON STAR System provides access to the most powerful radio traffic scheduler in the computer business. The key word in the AUTOTRON STAR System is: **Optimization**. It will optimize for maximum commercial content within station defined format restrictions to achieve optimum revenue opportunities. Products are protected, copy is rotated, schedules are horizontally and/or vertically rotated automatically. The entire process starts from a contract form not unlike the manual forms already in use by your station. That form is displayed on the CRT screen in a "fill-in-the-blank" format. The hand written sales order from the salesperson is entered into the system by the traffic operator. The system then prints out a copy of the sales order as it was entered. The sales staff has an immediate opportunity to review the computer version and make any desired changes.

FAST, SIMPLE & EFFICIENT

Additional schedule information, copy additions or changes can be made to existing sales orders without the need to re-enter names, addresses, billing information, etc. The new information is simply placed into the computer as additions to existing sales orders. Because the options of billing are so wide, any combination of invoice/affidavit needs can be met automatically by the system. The only entry other than the sales order entry that is required for the maintenance of the entire STAR System is the Reconciliation Process: Telling the computer what commercial messages did not run as scheduled and why, commercial messages that were substantially moved, or commercial messages that were written into the log during the air date. Notice that we have to deal only with the exceptions to the schedule generated by the computer. The AUTOTRON STAR System will re-

member where it scheduled the commercials so that affidavits will automatically be prepared at the end of the billing period.

Of course, cash receipts, debits, and credits to the accounts can be made at any time. At the end of the contract, end of the week, broadcast month or calendar month, on demand, or at any combination of these times, invoices are automatically prepared and printed onto invoice forms for immediate mailing. In addition to being able to control the frequency at which a client will receive an invoice, the sales/traffic department may control the format of the invoice sent. Some clients need to receive detailed affidavits for co-operative advertising, while others desire a simple summarized invoice.

GROWS WITH YOUR NEEDS

The benefits of the AUTOTRON STAR System can be expanded through the addition of systems for payroll, accounts payable and general ledger (financial reporting).

PAYROLL

The AUTOTRON STAR payroll system is a flexible solution to the headaches and reporting requirements of a typical payroll operation. The system can deal with employees on different pay frequencies, commissions, multiple taxing authorities, and the summarization of information for various local, state and federal reports. A side benefit is the preparation of a voucher check that recaps deductions and computation of net pay amount with year-to-date totals, providing your employee with more information than may be possible in your payroll system today.

ACCOUNTS PAYABLE

The AUTOTRON STAR accounts payable system provides an opportunity to manage the cash flow of your operation. Cash requirements are easily determined using the reports from the system. The system also interfaces automatically to the AUTOTRON STAR general ledger system. Expenses are recognized in the appropriate period and accounts payable and cash accounts are automatically updated as the system is run. The computer-prepared checks serve as subtle reminders to your vendors that this is an up-to-date, well managed business.



AUTOTRON CRT terminal features adjustable screen intensities and "fill-in-the-blank" forms. Terminal can be located up to 4,000 feet away from the computer.



150 CPS matrix printer is standard. Line printers rated to 900 lines per minute are available at nominal cost.

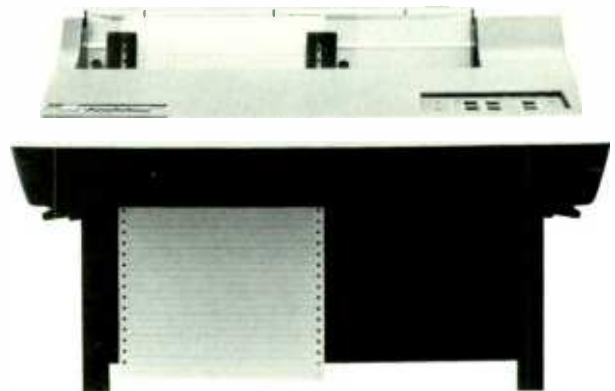

GENERAL LEDGER

The AUTOTRON STAR general ledger system can be of immediate benefit to the management of the radio station. The wide variety of comparative profit/loss statements, including comparisons to budget and/or prior year, provides the kind of tools necessary to direct and manage your property. These reports are available during the month as well as in a finalized form at the end of the month, placing the information in your hands in a more timely fashion than you probably receive it now.

The Harris AUTOTRON STAR System is without a doubt the most powerful, complete, expandable system ever designed for radio broadcasters. With the many options available for AUTOTRON, it is unquestionably the **Total Radio Business Automation System**.

THE HARRIS COMMITMENT TO AUTOMATION SYSTEMS

Harris Corporation is the originator of micro-computer program automation, and uses computer technology extensively throughout its product line. A sophisticated business auto-

mation system, then, was a natural progression in the company's product evolution.

Since 1976, AUTOTRON STAR Systems have been in use at large and small stations in a wide variety of markets across the country, consistently demonstrating the flexibility to meet the needs of broadcasters in every category.

SOFTWARE SYSTEMS

The AUTOTRON STAR System provides for sales, traffic, accounts receivable, general ledger, accounts payable, and payroll. Numerous individual reports are available in these general categories to give enormous reporting function capabilities. A complete set of reports from all systems is available on request.

OPTIONS: WORD-PROCESSING SYSTEM (WPS)

By using the AUTOTRON computer and adding a "typewriter-quality" printer, all of the speed and convenience of text-preparation and form letters is inexpensively available. By typing onto the CRT terminal, a perfect letter can be created, then

justified and reproduced as often as wished. If a word or phrase needs changing, WPS will do so and automatically rejustify. WPS contains many other features and merits a demonstration.

WPS has been favorably compared with many popular word-processing-only systems. But when combined with the ability to use information from the AUTOTRON STAR System, it provides a unique and powerful tool. WPS has sub-systems for electronic mail, list processing, calculator functions, and electronic calendar/scheduling.

BACKGROUND MUSIC ACCOUNTING SYSTEM (BMAS)

A companion system to AUTOTRON Accounts Receivable, BMAS provides invoicing, statements and all other accounts receivable reports. Plus, BMAS provides MUZAK, ASCAP, and BMI reports.

MUSIC LIBRARY SYSTEM (MLS)

MLS allows the cataloging of music

by title, artist, record number, label, library record location and library cartridge and/or tape location(s). MLS also provides the structuring of single or recurrent music-logs. These printed music-logs provide selection, number, artist, title and length in stop-sets and give total stop-set timing. A final cross-reference report indicates which stop-sets include particular selections over a multiple-week period.

HARDWARE

The Harris AUTOTRON STAR System utilizes the Honeywell Information Systems DPS-6 mini-computer system. The DPS-6 computer is modular for repair and growth purposes, and can accept new devices through plug-in capability. The system is normally supplied with a mini-cabinet which holds the computer itself. AUTOTRON is available with 128K to 1,024K bytes of memory and a 13, 26 or 80 megabyte disk drive with built in back-up capabilities. A specific configuration would depend on needs and software options desired.



Well laid-out keyboard makes AUTOTRON's "operator friendly" CRT terminal easy to use.



The standard computer is installed with one CRT terminal and one printer, and has the ability to add additional devices as well as add the ability to communicate with other computer systems at other radio stations within the group.

AUTOTRON utilizes matrix printers rated from 150 characters per second and line printers to 900 lines per minute. The 150 CPS printer is standard.

The Honeywell CRT terminal can be located up to 4,000 feet away from the computer. Ease of operation, varying screen intensities and "fill-in-the-blank" forms are standard on this "operator friendly" terminal.

HARDWARE OPTIONS

Extra CRT terminals or serial printers (to a limit of 16); extra line printers (to a limit of 4); and inter-site communications are available with AUTOTRON. Hard disc may be expanded to 80 megabytes in as many as four units, for a total of 320 megabytes. All these features may be purchased initially or added at a later date.

AUTOTRON SYSTEM SERVICE

Service for the AUTOTRON STAR System hardware is provided nationwide by the Honeywell Field Engineering Division. Approximately thirty-five hundred (3500) trained

technicians are in cities coast to coast, and are served by local, district and regional parts depots. In addition, a 24-hour, 7-day-per-week "Response Line" exists for AUTOTRON users. This number is answered by a trained Harris AUTOTRON support technician in the AUTOTRON Response Center at all times.

A quick diagnosis of problems is provided as a part of the ongoing support of the AUTOTRON product in the field. If a problem is determined to be hardware related, the Honeywell Field Engineering Division is contacted. An engineer in the station's area is notified for immediate correction of any failure.

The Harris AUTOTRON STAR System includes various sub-systems with enormous reporting functions. The preceding information and sample reports generally describe the flow and capability of the AUTOTRON STAR System. However, those reports are only representative and comprise a small portion of the entire reporting capability of the System. A complete set of full reports from all sub-systems is available upon request. A complete list of reporting functions follows:

Sales System Reports

Account Executive Master List
Industry-Product Master List
Segment/Program/Avail Master List, Chronological
Segment/Program/Avail Master List, By Type Within Day
Segment/Program/Mail Master List, By Day Within Type
Agency-Client Master List
Alphabetical Agency List
Alphabetical Client List
Alphabetical Client List By Salesperson
Alphabetical Sales Order Master List, Summary

Numerical Sales Order Master List, Summary
Sales Order Master List Summary By Salesperson
Alphabetical Sales Order Master List, Detail
Numerical Sales Order Master List, Detail
Sales Order Master List, Detail By Salesperson
Sales Order Master List, Detail by Revision Date
Sales Order Confirmation, Single or Multiple Copies
Contract Expiration List
Revenue Projection, By Salesperson
By Account
By Contract
Major Product Availabilities
Mailing Label Printing
To Agencies
To Clients

Traffic System Reports

Availability Summary, to 13 weeks
Detail Availability Listing, next 2-weeks
Calendar Month Revenue Projection
Broadcast Month Revenue Projection
Alphabetical Detail Program Log Audit
Pre-log
Operating Schedule-Performance Log
Skeleton Operating Schedule-

Performance Log
Make Good Listing
Daily Revenue Recap
Daily Client Recap
Chronological Revised Program Log Audit
Alphabetical Revised Program Log Audit
Billing Audit by Contract

Accounts Payable System Reports

Initial Vendor Creation Audit List
Vendor Master Maintenance
Vendor Master Listing (Numeric)
Vendor Master Listing (Alphabetic)
A/P Transactions Entry Listing
Edit Program Exceptions Listing
A/P Open File Update
Transactions File Listing
Accounts Payable Register
Account Distribution Report
Open A/P Trial Balance by System Date
Open A/P Trial Balance by Operator Input Date
Payfile Update
Vouchers To Be Paid
Invoices Choices Maintenance
A/P checks
Cash Transaction to G/L
Weekly Check Disbursements Report
Monthly Check Disbursements Report
Consolidated Monthly G/L Report

Accounts Receivable System Reports

Current Activity Report
Invoice Register
Detailed Invoice Register
Invoice/Affidavit, Exact Time
Invoice/Affidavit, Nearest Quarter Hour
Invoice/Affidavit, No Times
Invoice/Affidavit, Totals Only
(Above Invoice/Affidavits types may also reflect Per Contract or Per Aired and Per Copy)
Statement
Aged Trial Balance By Account
Aged Trial Balance By Salesperson
Aged Trial Balance By Account, By Salesperson
Detailed Audit Report

General Ledger System Reports

Initial File Load Audit Listing Balances
Initial File Load Audit Listing Chart Of Accounts
Initial File Load Audit Listing Cross Reference File
Initial File Load Audit Listing Budget Amounts File
New Master From Old Master
New Chart From Old Chart
New Cross Reference From Old Cross Reference

New Budget From Old Budget File
Master File Maintenance Audit List
Chart Of Accounts Maintenance Audit List
Cross Reference Maintenance Audit List
Budget Amount Maintenance Audit List
Chart Of Accounts Listing
Master Balance File List
Cross Reference File List
Budget Amount File List
General Ledger Proof Report
General Ledger Transactions Listing
Transactions Maintenance Audit Listing
Financial Statement Worksheet
General Ledger Report
Master File Update Listing
Balance Sheet
Income Statement (Cur. Month vs Y-T-D)
Income Statement (Cur. Month vs Cur. Budget)
Income Statement (Current Months Budget)
Income Statement (This Y-T-D vs Last Y-T-D)
Income Statement (Cur. Month vs Same Mo. Last Year)
Income Statement (By Division)
Income Statement (6 Column Comparative)

Payroll System Reports

Employee Master File List
Recurring Earnings And Deduction File List
Balance And Edit Current Earnings List
Current Earnings Maintenance List
Balance And Edit Deductions List
Deductions Maintenance List
QTD/YTD Adjustments List
QTD/YTD Maintenance List
After-the-Fact Earnings List
After-the-Fact Maintenance List
Payroll Register
Deduction Registers (Up To 99 Reports)
Payroll Checks
Payroll Check Register
Nontaxable Income List
Departmental Recap Of Earnings
Deductions Not Taken Report
Employee Quarter To Date Earnings Register
Quarterly Earnings Report
Wages Subject To Unemployment Report
941A Reports
Employee Quarter And Year To Date Report
Employee Year To Date Register
Employee W2 Reports

Specifications subject to change without notice.



HARRIS

Autotron Star Word Processing Work Station

- Quick and simple hookup to Harris Autotron Star Business Automation System
- Detachable typewriter-style keyboard
- Word processing function keys
- Vertical and horizontal scrolling
- 12-inch diagonal non-glare screen
- Compact design for desk top use



Now broadcasters can control massive amounts of paperwork and associated production and handling costs. With Harris Autotron Star Word Processing, complete data processing and office automation capabilities are available. Maximize operations and minimize paperwork while you maintain a lean, efficient staff! A quick, simple hookup to an Autotron Star Business Automation System puts your station in a new era of office operations.

DOCUMENT PREPARATION

The WST7313 Word Processing Work Station provides an exceptional document preparation capability. Applications such as form letter writing, contract preparation, demographic avails, recurring reports or other repetitive tasks can be completed more quickly, resulting in faster production turnaround. Autotron Star's Word Processing Work Station provides a full range of text-processing features, allowing for easy document assembly, editing, formatting and statistical typing, with prompting messages appearing on the screen to assist and guide the user.

FEATURES

Each Work Station operates at 9600 bits per second, and attaches to Autotron Star's DPS-6 computer system by a direct-connect cable from 50 to 1000 feet in length. The unit is compact, and specifically designed for desk top use. An audible alarm is activated whenever the ACSII bell code is recognized, and includes hardware confidence tests which are automatically performed during power-up. The detachable keyboard features solid-state keys arranged to optimize use in word processing applications. The system provides horizontal scrolling, allowing the operator to view 160 character wide documents.

SIMPLIFIED TEXT ENTRY

Many automatic controls are included for text entry and editing. These include word wraparound; indentation; decimal alignment; centering; underscoring; superscript/subscript;

hyphenation; left right justification; and pagination. Eleven separate text revision features enable the user to modify existing text and add new text anywhere in the document.

DOCUMENT FILING AND RETRIEVAL

The Autotron Star Word Processing Work Station manages information efficiently. All documents are identified by name, title, author, creation date and storage medium. An index of all documents is automatically generated and may be displayed or printed. Documents can be filed on any user-specified medium when multiple diskette and hard disk drives are used.

PRINTERS

Letter quality printers permit use of 10- or 12-pitch and multiple type fonts. The printers feature bidirectional printing, current loop interface and up to 55 characters per second print speed. Wide margin printing allows up to 160 character lines in the 12-pitch configuration. Cut-sheet feeder and forms tractor are optional.

To broadcasters, time means money. The new Harris Autotron Star Word Processing Work Station helps you make the most of your time, your staff's time, and your total office resources.

SPECIFICATIONS

CRT TERMINAL

Display Size/Type: 12-inch diagonal nonglare screen in green phosphor

Display Character Positions: 1920

Data Space: 24 lines of 80 characters, plus 25th line for operator message and prompting line

Status Line: 80-character terminal status line display

Character Matrix: 9 x 13 dot matrix field—uppercase; 7 x 9 dot matrix—lowercase

Keyboard Performance Characteristics: Standard typewriter arrangement with word processing function keys, including: INDENT, GO TO PAGE, CENTER, DEC TAB, MERGE, FORMAT, SUPERSCRIP/T/SUBSCRIPT, STOP, INSERT, DELETE, COPY, SEARCH, REPLACE, and MOVE

Dimensions: 18.0"W x 17.7"D x 13.3"H

Weight: 9.0 lbs.

Combined Display and Keyboard: Depth—23.8"
Weight—65.5 lbs.

Voltage: 120 VAC single-phase (± 10%), 3.3 amps

Frequency: 60 Hz ± 0.5 Hz

Power Consumption: .34 kVA

Heat Dissipation: 940 Btu/hr

Operating Temperature: 50°F to 100°F (10°C to 38°C)

Relative Humidity: 10%–80% noncondensing

Interface: Current loop (20 MA)

Code and Transmission Mode: Uses asynchronous serial 7-bit ASCII code characters plus parity, with start and stop bit(s); parity bit may be odd, even, mark, or space

PRINTER

Print Speed: 55 cps (max) in 12-pitch mode

Character Set: 128 characters (max), fully formed

Print Line: 136 columns (10-pitch), 160 columns (12-pitch)

Printing Operation: Bidirectional

Line Spacing: 6 or 8 lines per inch, operator selected

Column Spacing: 10-pitch mode—10 characters per inch, 136 characters per line. 12-pitch mode—12 characters per inch, 160 characters per line

Paper Feed: Friction-feed platen (standard); bidirectional forms tractor (optional)

Paper Feed Speed: 4.6 ips plus 53 ms typical settling delay

Paper Width: 16 inches (max)

Paper Thickness: Standard settings permit single sheet or multiple form thickness up to 0.027 in.

Platen: Friction feed

Auxiliary Paper Handling Devices: Forms tractor and cut sheet feeder (optional)

Dimensions: 9.8"H x 24.8"L x 19.21"W

Weight: 45.5 lbs.

Interface Standard: Current loop

Communications Code: ASCII

Operating Temperature: 40°F to 100°F (5°C to 38°C)

Relative Humidity: 30% to 85% noncondensing

Power: 115 VAC (± 15%), 3.5 A

Frequency: 60 Hz (+ 5%, - 3%)

Power Consumption: .24kVA

Heat Dissipation: 357 Btu/hr

SPECIFICATIONS SUBJECT TO CHANGE WITHOUT NOTICE

ORDERING INFORMATION

Word Processing Work Station WST7313, with keyboard, CRT, and 50 feet of cable 749-0089-000
Word Processing Printer Terminal PRT1004, with 50 feet of cable 749-0091-000
Word Processing Software license, to operate with Autotron Star System 746-0014-000



HARRIS

Office Automation Infowriter

- Easy to use
- Supports both word processing and data processing for greater flexibility
- 12-inch diagonal screen with tilt mount reduces operator strain
- Electronic mail speeds correspondence
- Automatic self-test eases diagnosis of equipment problems
- High capacity mini-disk units reduce operator interruption for swapping diskettes

The Infowriter is a self-contained, tabletop sized entry-level word processing system. The basic Infowriter (without printer) consists of a single CRT workstation with detachable keyboard; dual 650K-byte (formatted) mini-disk units; a word processor computer with 128K-bytes of memory; and one synchronous communication line for general purposes.

COMPACT AND CONVENIENT

All features are fully integrated into a compact, attractively styled enclosure. The Infowriter is available with either a 35- or 55-cps letter quality printer. An optional two-way manual switch enables the sharing of a printer between two Infowriters.

APPLICATIONS

Word and document processing applications available for the Infowriter include: document preparation; printing and archiving; a document sorting capability which permits the listing of recorded text in ascending or descending order; an abbreviation facility allowing standard text and commands to be stored and transferred when needed to any applicable document with minimum keystrokes.

Two additional applications available are electronic mail and records processing. The electronic mail facility allows documents to be sent or received over communications lines linked to other Infowriters, office automation systems, or suitably programmed Harris Autotron systems. The records processing facility allows the entry, editing, selective processing and printing of a list document through the use of an entered or stored form. These applications are available on special diskettes.

ADDITIONAL FEATURES

Other notable features include a built-in automatic self-test which is initiated at power-up; an adjustable brightness control; simple, single-button system startup procedure; and document diskettes exchangeable with other Infowriter systems. There's also a backup utility for saving documents. The entire unit may be tilted either forward or backward for operator convenience.



SPECIFICATIONS

CRT TERMINAL

Display Size/Type: 12-inch diagonal (30.5 cm) nonglare, green phosphor
Character Positions: 2000 (1920 plus 80 for system line)
Data Space: 24 lines of 80 characters each, plus system line of 80 characters
Character Matrix: 9 x 13 dot matrix field (uppercase uses a 7 x 9 dot matrix field; lowercase, with descenders, uses a 7 x 10 dot matrix field)
Display Capability: 120 characters, composed of a 95-character ASCII set and 14 word processing symbols

KEYBOARD

Layout: Standard typewriter arrangement with word processing function keys, including: INDENT, GO TO PAGE, CENTER, DEC TAB, MERGE, FORMAT, SUPERSCRIP/T/SUBSCRIPT, STOP, INSERT, DELETE, COPY, SEARCH, REPLACE, and MOVE

PHYSICAL CHARACTERISTICS

Width: 18.5 in. (47.0 cm)
Depth: 9.0 in. (22.9 cm)
Height: 3.5 in. (8.9 cm)
Weight: 9.0 lbs. (4.1 kg)

MEMORY

Memory Size: 128K bytes
Memory Type: Single-fetch, high-density MOS
Memory Checking: Parity

MINI-DISKETTE UNITS

Number of Units: 2 (standard)
Number of Spindles: 1 per unit
Seek Time: Maximum¹ (80 tracks)—415 ms
Minimum (track to track)—3 ms
Average¹ 175 ms
Average Rotational Latency: 100 ms
Transfer Rate: 31.3K byte/s
Data Capacity (formatted): Bytes/Sector—256
Sectors/Track—16
Tracks/Surface—80
Surfaces—2
Bytes/Device—650K
Diskette Speed: 300 rpm
Medium: Double-sided, flexible, 5/4-inch diskette

¹ Excludes head settling time of 100 ms

PHYSICAL CHARACTERISTICS (Infowriter without keyboard)

Width: 20.5 in. (52.1 cm)
Depth: 19.0 in. (48.1 cm)
Height: 16.0 in. (40.6 cm)
Weight: 71.0 lbs. (32.2 kg)

ELECTRICAL CHARACTERISTICS

Power: 120 VAC (+ 10 %, - 15%)
Frequency: 60 Hz (± .5 cycles)
Power Consumption: 0.23 kVA
Heat Dissipation: 785 BTU/hr (198,762 calories/hr)

ENVIRONMENTAL CHARACTERISTICS

Operating Temperature: 50°F to 100°F (10°C to 38°C)
Relative Humidity: 20% to 80% (noncondensing)

PRINTER

Print Speed: 55 cps (max) in 12-pitch mode
Character Set: 128 characters (max), fully formed
Print Line: 136 columns (10-pitch), 160 columns (12-pitch)
Printing Operation: Bidirectional
Line Spacing: 6 or 8 lines per inch, operator selected
Column Spacing: 10-pitch mode—10 characters per inch, 136 characters per line. 12-pitch mode—12 characters per inch, 160 characters per line
Paper Feed: Friction-feed platen (standard); bidirectional forms tractor (optional)
Paper Feed Speed: 4.6 IPS (11.7 cm/s) typical settling delay
Paper Width: 16 inches (41 cm) maximum
Paper Thickness: Standard settings permit single sheet or multiple form thickness up to 0.027 in. (.6858 mm)
Platen: Friction feed
Auxiliary Paper Handling Devices: Forms tractor and cut sheet feeder (optional)
Dimensions: 9.8"H x 24.8"L x 19.21"W (25 cm x 63 cm x 49 cm)
Weight: 45.5 lbs. (21 kg)
Interface Standard: Current Loop
Communications Code: ASCII
Operating Temperature: 40°F to 100°F (5°C to 38°C)
Relative Humidity: 30% to 85% noncondensing
Power: 115 VAC (+ 5%, - 3%)
Power Consumption: .24 kVA
Heat Dissipation: 357 Btu/hr (90,392 calories/hr)

SPECIFICATIONS SUBJECT TO CHANGE WITHOUT NOTICE

ORDERING INFORMATION

Single Station Infowriter System (CPX9614)	749-0128-000
Single Station Infowriter System with 35-cps Letter Quality Printer (CPX9616)	749-0129-000
Single Station Infowriter System with 55-cps Letter Quality Printer (CPX9617)	749-0130-000



HARRIS

MICRO MAC

MODULAR AUDIO CONSOLE



Digitally Controlled With Protected Memory

A MAJOR BREAKTHROUGH IN AUDIO CONSOLE DESIGN . . .

Harris MICRO MAC

- **SELECTABLE 1-16 INPUT CHANNELS**
2 sources per input channel
Source start/stop switching of selected A or B source
- **SELECTABLE 1-4 OUTPUT CHANNELS**
Stereo Program, Stereo Audition, Stereo Auxiliary & Mono Sum
- **3 ASSIGNABLE SUBMASTER CHANNELS**
- **TROUBLE-FREE LINEAR ATTENUATORS**
No routine maintenance required
Complete immunity to coffee, smoke, ashes, dust and dirt
No change in attenuation or noise with operation or time
Stereo tracking within 0.5 dB over entire attenuator range
- **PEAK READING and/or VU METERS**
- **KEYBOARD ENTRY OF MANY FUNCTIONS**

The Harris MICRO MAC Modular Audio Console incorporates a "start from scratch" philosophy that makes it unique. It's the first broadcast audio console with digital microprocessor memory. With microprocessor control and revolutionary linear attenuators, the MICRO MAC represents a major breakthrough in audio console design. Most control room errors are eliminated in routine board operation. User memory is protected from brown-outs and power interruptions. And user convenience is paramount, with virtually all switch assignments, attenuator positions and other control parameters digitally scanned continuously and updated per operator command.

Numerous software controlled functions make the MICRO MAC a bigger board than its size would indicate. Some of these include speaker muting assignment of control room and up to four studios; cart machine replay lockout and override; stop-delay of reel-to-reel machines; and a choice of latching or non-latching start/stop switching of up to 32 source machines! The MICRO MAC's modular design accepts 1 to 16 input modules of 3 different types for the ultimate in audio performance and flexibility.

PROGRAMMABLE ATTRIBUTES

By entering user commands in the MICRO MAC memory, or enabling routines already stored there, many programmable attributes may be used to enhance operation. They include:

- Muting assignment of speakers in the control room and up to four studios by keyboard entered numeric characters
- Choice of latching or non-latching start/stop switching for up to 32 sources
- Enabling Timer to restart each time a channel is activated to time segments or to utilize pre-timed segments
- Enter elapsed time in Down Timer to show remaining time allotted for certain events or segments
- Stop delay for Reel-to-Reel machines for accurate cueing of next selection on program tapes

- Operating warning and play command lockout to cart machines to prevent back-to-back playing of same cart
- Accurate and convenient setting of 12/24 hour Real Time Clock
- Automatic logging of a live operation with serial ASCII data output connection to external log printer, showing:
 - Start time of each new event (change or restart of source)
 - Input channel number (1-1 through 16-2, 32 total)

INPUT MODULES

Each input module contains a 2-position input selector switch with transferred status and logic control to the selected source. This effectively doubles source capacity of the console when all 16 input channels are installed to a total of 32 miscellaneous sources. The input control modules may use an associated Mono Microphone Input Board, Stereo Low-Level Input Board, or Stereo Medium-Level Input Board, depending on the type of source connected into it

ASSIGNABLE SUBMASTER BUSES

Three submaster buss assignment switches on each input module are provided for grouping of the various source types. Each submaster channel allows insertion of external effects or processing units such as an audio processor, filter, equalizer, effects, or reverberation, for signal enhancement. The level is controlled by the A, B, or C Submaster linear attenuator; output may be directed to PGM, AUD, AUX and/or MONO output lines. The result is a far more effective, flexible system than could be obtained with plug-in effects/limiter/EQ modules.

LINEAR ATTENUATOR

An exclusive design in a digitally scanned attenuator provides trouble-free performance with no routine maintenance. Its digital

output signal, designating the position of the actuator, is converted to an analog VCA control voltage, which operates true VCA (voltage controlled amplifier) gain elements. There is only one moving part, a mechanical assembly. Its position is sensed by sealed LEDs and detectors.

Complete immunity to poor environmental conditions is facilitated by this design. Coffee spills, cigarette smoke and ashes, airborne dust and dirt—agents that degrade operation of the best conductive plastic attenuators—are not a factor on the MICRO MAC. In those extreme situations, excessive build-ups may be simply wiped off attenuator elements, restoring them to new operating condition. And attenuator life is virtually unlimited. Stereo tracking within 0.5 dB over the full attenuator range is another important feature of the MICRO MAC linear attenuator. Compare this with any other attenuator, such as the dual step type or dual conductive plastic, with their staggered steps and wide tolerance audio taper curves.

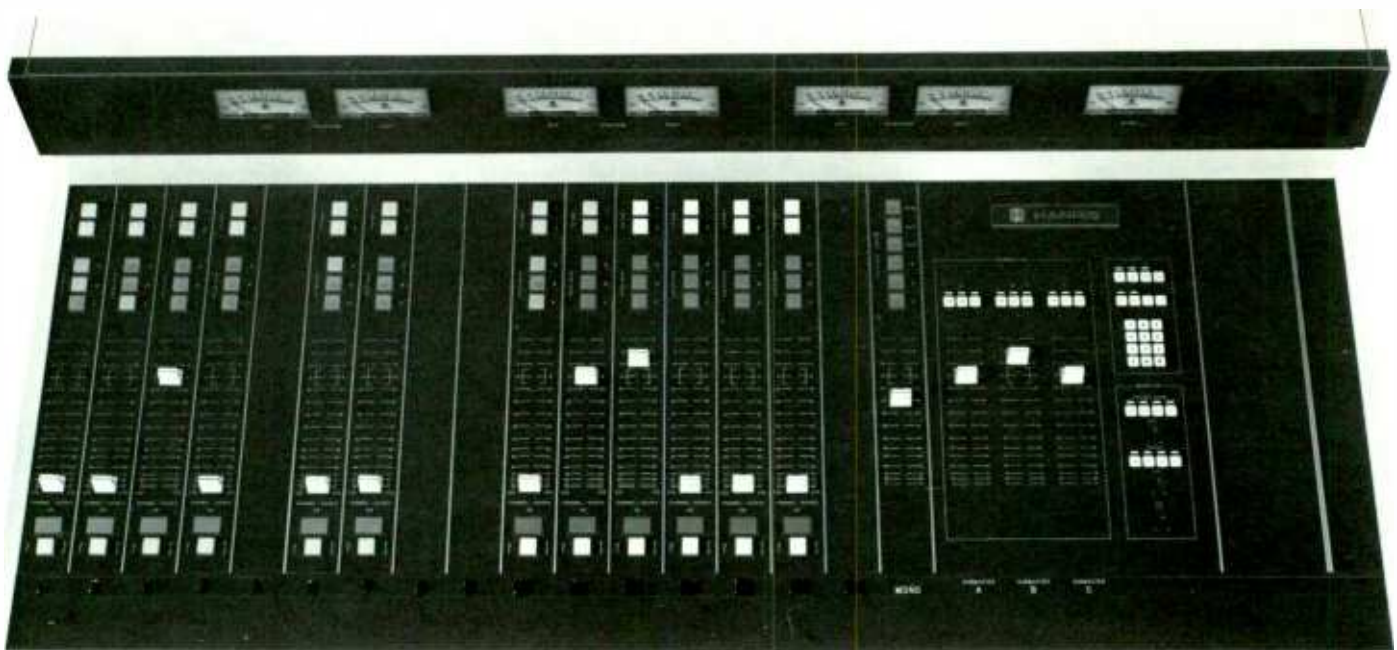

Unparalleled Flexibility, Unexcelled Performance

INPUT CHANNEL ON/OFF

Illuminated, color-coded switches at the bottom of the input channel panel turn the channel on and off. In addition, they may be used to start and stop external sources through the optional dual machine interface cards. Actual switching circuits for the source machines are opto-isolated to prevent any chance of switching transients being induced into the console program circuits.

INPUT CHANNELS

All three types use true instrumentation amplifiers as active (transformerless) balanced inputs for practically transparent operation. Amplifier input impedance is approximately 10K ohms, so the input impedance of the channel is determined by the loading resistor.

The Mono Mic and Stereo Lo-Level Input Channel Boards have at least 30 dB of headroom. They can accept -30 dBm, or even more, with a nominal -60 dBm input gain setting. A P-C mounted DIP (Dual In-line Package) switch provides gain trim or adjustment in 10 dB steps, from -70 to -40 dBm nominal input levels. The Medium Level Input Channels also have 30 dB of headroom. They are designed for a nominal input level of -20 dBm and have a DIP switch gain adjustment in 10 dB steps to accommodate a -30 to +10 dBm input level.

VU/PEAK METER

From 1 to 7 meters may be selected as a combination VU and Peak Reading meter, or VU meter only. The VU meter meets all ASA specifications, and is driven with an isolation/buffer amplifier to prevent meter diode generated distortion in the program circuits. The Peak Reading meter has 11 LEDs mounted across the top of the meter scale. They are calibrated +5, +7, and so on, @ 2 dB per division, up to +23 dBm - plus

OL (overload calibrated for +30 dBm output of program amplifiers). The VU meter has a precision calibration to adjust for an amplifier output of 0 VU, +4 VU or +8 VU with the meter reading zero. Thus, the output level of the MICRO MAC's program lines may be set to the desired point for the system. The peak reading LED portion of the meter is extremely fast in operation in its factory configuration. It can easily be modified to approximate the DIN PPM (Peak Program Meter) meter characteristics.

OUTPUT CHANNELS

Stereo Program, Stereo Audition, Stereo Auxiliary and Mono/Sum channels may be added to the console by adding up to 7 Output Amplifiers (3 pairs for stereo plus mono) and VU or VU/PEAK meters. The Output Amplifiers have active (transformerless) balanced outputs with extremely high slew rates, making them practically transparent. Output capability is at least +30 dBm into a 600 ohm load, providing from 22 dB to 30 dB of headroom with the output level adjusted for +8 VU to 0 VU. The MONO output channel can be fed a compatible or sum signal from the stereo PGM, AUD, AUX, Submaster A, Submaster B and/or Submaster C channels. This provides complete flexibility seldom found in other consoles.

SUBMASTER/KEYBOARD/ MONITOR MODULE

Selector switches above the submaster faders connect them to the PGM, AUD and AUX output channels, individually or collectively. All submaster feeds are buffered so that multiple feeds cause no crosstalk between channels. The Control Room and Studio Monitor sections each have input selectors for PGM, AUD, AUX and EXT feeds. Monitor section output is approximately 1 volt for driving external speaker amplifiers.

The Keyboard/Edit section contains switches labelled SET CLOCK, UP TIMER, DOWN TIMER, START/STOP, EDIT, ENTER, ADVANCE and CLEAR. An additional 12-button key pad provides for numeric entry of user instructions in the console memory.

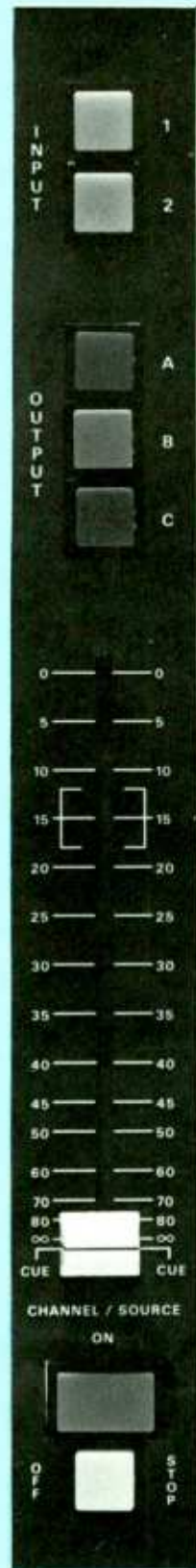

Harris MICRO MAC input module with linear attenuator actuator.

MICRO MAC SPECIFICATIONS

OPERATING MODE: Stereo in up to 3 output channels, plus mono/sum.

MIXING CHANNELS: Optional, from 1 to 16 mono mic, low-level stereo or medium-level stereo channels that can be assigned to desired sources.

INPUT CIRCUITS: From 2 to 32, depending on number of input modules in the console.

OUTPUT CIRCUITS: Total 7: Stereo Program, Stereo Audition, Stereo Auxiliary, Mono/Sum, Stereo Studio Monitor, Stereo Control Room Monitor, and Cue Amplifier.

SOURCE IMPEDANCES:

Microphones: 150/250 ohms, balanced.

Stereo low-level: 150/250/600 ohms, balanced.

Stereo medium-level: 150/250/600 ohms, balanced.

GAIN

MIC CHANNEL: 92 dB nominal with 0 VU output level, 100 dB nominal with +8 VU output level.

LOW-LEVEL INPUT CHANNEL: 92 dB nominal with 0 VU output level, 100 dB nominal with +8 VU output level.

HIGH-LEVEL INPUT CHANNEL: 52 dB nominal with 0 VU output level, 60 dB nominal with +8 VU output level.

FREQUENCY RESPONSE: ± 0.25 dB maximum from 20 Hz to 20 kHz in all program and monitor circuits.

DISTORTION

THD (HARMONIC): Less than 0.1% from 20 Hz to 20 kHz below the +30 dBm overload indicator point in all program input/output channels and monitor circuits.

IMD (INTERMOD): Less than 0.1% with SMPTE 4:1 mix below the +30 dBm peak equivalent level in all program input/output channels and monitor circuits.

NOISE

MIC CHANNEL: -125 dBv equivalent input noise, 20 Hz to 20 kHz bandwidth unweighted, with -50 dBv input level into one active input channel.

LOW-LEVEL INPUT CHANNEL: -125 dBm equivalent input noise, 20 Hz to 20 kHz bandwidth unweighted, with -50 dBm input level into one active input channel.

HIGH-LEVEL INPUT CHANNEL: -90 dBm equivalent input noise, 20 Hz to 20 kHz bandwidth unweighted, with -10 dBm input level into one active input channel.

POWER: 117/234 volts, $\pm 10\%$, 50/60 Hz, 350 watts maximum.

SIZE

MAIN FRAME: 1308 mm (51.5 in.) width, 584 mm (23 in.) depth, 194 mm (7.65 in.) projection above and 102 mm (4 in.) below table top surface, with 1276 mm (50.25 in.) by 527 mm (20.75 in.) cutout in table top.

INPUT CARD CAGE: 311 mm (12.25 in.) height, 483 mm (19 in.) width, 356 mm (14 in.) overall depth.

OUTPUT CARD CAGE: Same as Input Card Cage.

DIGITAL POWER SUPPLY: 133 mm (5.25 in.) height, 483 mm (19 in.) width, 279 mm (11 in.) overall depth.

DUAL MACHINE CARD CAGE: 267 mm (10.5 in.) height, 483 mm (19 in.) width, 356 mm (14 in.) overall depth.

MONITOR/INTERCOM RELAY MUTING UNIT: 178 mm (7 in.) height, 483 mm (19 in.) width, 102 mm (4 in.) overall depth.

NET WEIGHT: 298 kg (135 pounds) for Main Frame, 220 kg (100 pounds) for other 5 units listed above.

DOMESTIC PACKED WEIGHT: 596 kg (270 pounds) for Main Frame, 440 kg (200 pounds) for other 5 units listed above.

SPECIFICATIONS SUBJECT TO CHANGE WITHOUT NOTICE

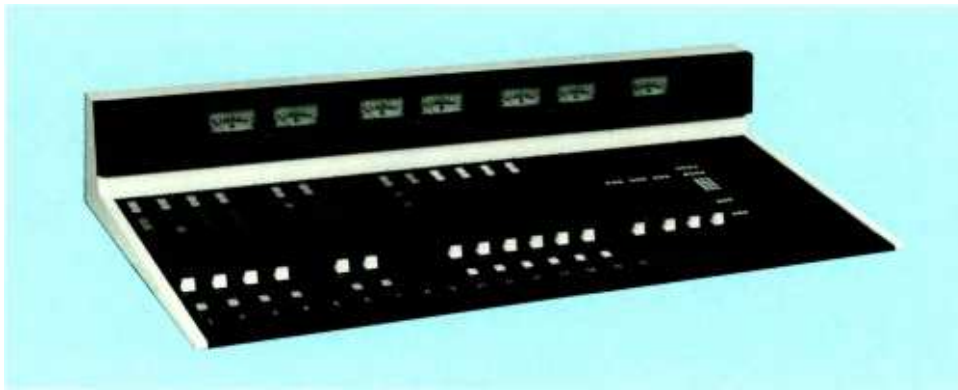

ORDERING INFORMATION

Control Console Main Frame (order 1)	994-8571-001
*These items supplied with Main Frame	
Up/Down Timer*	992-5832-001
Submaster/Keyboard/Monitor Module*	992-5831-001
System Interconnect Cable*	992-5901-001
Operational Program*	992-5902-001
Input Control Module (order 1-16)	994-8563-001
Mono Control Module (order 0-1)	
Contains 994-8577-001 Mono Switcher Board	994-8564-001
Studio Talkback Module (order 0-1)	
Contains 994-8593-001 Studio Talkback Driver Board	994-8566-001
12/24 Hour Real Time Clock (order 0-1)	994-8560-001
Standard VU Meter (order 0-7)	994-8561-001
VU/Peak Level Meter (order 0-7)	994-8562-001
Digital Power Supply* - rack mounted	994-8598-001
Input Card Cage* - rack mounted	
Holds 16 plug-in Input Boards plus Summing Board	994-8572-001
Summing Board*	992-5848-001
Mono Mic Input Board (order 0-16)	994-8556-001
Stereo Low-Level Input Board (order 0-16)	994-8555-001
Stereo Medium-Level Input Board (order 0-16)	994-8554-001
Output Card Cage* - rack mounted	
Holds following plug-in boards & power supply	994-8573-001
Submaster VCA Boards* (3)	992-5853-001
Analog Power Supply Chassis*	992-5854-001
Hi-Level Output Amplifier Board (order 1-7)	
2 each for stereo, 1 for mono line outputs	994-8579-001
Monitor Selector Board (order 0-2)	994-8578-001
External Effects/Processing Interface (order 0-3)	994-8576-001
DMI Card Cage (order 0-1) - rack mounted	
Holds the following plug-in boards	994-8574-001
Dual Machine Interface Card (order 0-16)	
1 for each input channel with remote control of 1 or 2 source machines	994-8568-001
Monitor/Intercom Relay Muting Unit (order 0-1) - rack mounted	994-8575-001
Console Main Frame Extender Card (order 0-1)	939-5776-002
Input Card Cage Extender Card (order 0-1)	939-0209-001
Summing Board Extender Card (order 0-1)	939-5776-093
Output Card Cage Extender Card (order 0-1)	939-5776-087
DMI Card Cage Extender Card (uses input card cage extender card)	939-0209-001
Blank Main Frame Module (order 2-17)	
2 required in extreme right unassigned area, plus 1 each for unused input channels and studio talkback position	994-8621-001



HARRIS

M90

Production/On-Air Modular Audio Console

- Sophisticated audio control for the radio and television broadcaster, yet easy to operate
- High RFI/EFI immunity
- Factory pre-wired and tested, but field expandable
- Two, four and eight output channel configuration
- Up to thirty-four input mixing positions
- Up to sixty-eight inputs—more on special order
- Customer selected module placement
- Penny & Giles linear motion attenuators
- Optional EQ on each mono input module
- Switchable Hi Pass/Lo Pass filter on each mono input
- Input level of -70dBm to $+20\text{dBm}$ with gain trim
- LED function indicators
- Independent monitor feeds
- Input and output monitoring



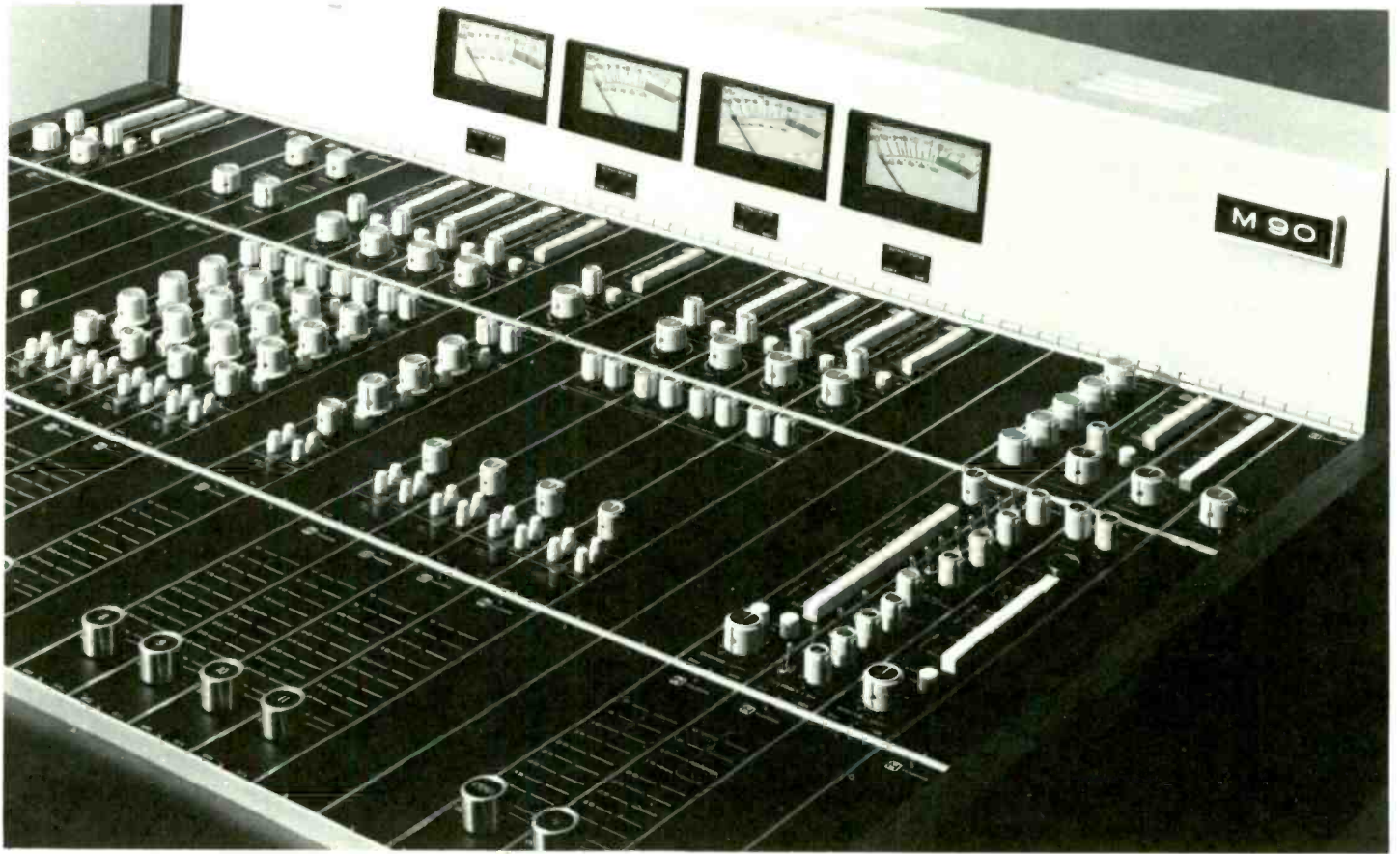

M90 control board, showing typical 4-output channel configuration.

One of the most versatile audio consoles available today, Harris' Model M90 is an expandable, completely modular, professional on-air/production/reinforcement unit. The console provides 2 or 4 output channels with up to 34 mixing positions (52 inputs), or up to 32 mixing positions (48 inputs) in the 8 output channel version. Combined monaural output is standard in the 4 output channel version.

Customization of each M90 is readily accomplished by selecting, from a wide variety of plug-in modules, those that exactly meet your requirements. In addition, there are a number of easily altered console functions that are "programmed" by the use of jumper wires, creating a broad choice of operating characteristics.

The M90 provides complete VU metering. Optional items include two echo send/return channels; talkback communications; programmable control room and studio muting; EQ at each mono input; two foldback mix outputs; a slate/test oscillator; stereo inputs; and a full line of matching accessories including a plug-in patch bay.

A full capacity system, the M90 fills the gap between conventional broadcast consoles and sophisticated recording consoles, with additional flexibility to meet demanding requirements of quality conscious broadcasters.

Depending on the choice of modules, the M90 is ready to be used in many different applications.

ON-AIR

The M90, in the 4 channel version, functions as either a mono or stereo on-air broadcast console. It may be configured to provide simultaneous discrete mono and stereo feeds (rather than limiting the mono output to an inferior summing of the stereo program). Summed mono is available, primarily for checking phase compatibility (or where time does not allow a discrete mono mix to be established). Monitor muting is interfaced to the input module On/Off and Mic/Line switches in typical on-air fashion, except that reprogramming of muting is vastly simplified and improved by the use of Transistor-Transistor Logic (TTL) circuitry instead of relay logic.

PRODUCTION

The M90 also functions in the 4 channel configuration as a production console, with discrete program outputs suitable for professional multi-track recording and broadcast production. For these applications, the console is equipped with completely independent monitor feeds for the control room, studio, and foldback headphones. An important monitoring function is served by the built-in, 2-section, 4-channel overdub/foldback mixer which permits sync playback of previously

recorded tracks with the program output of the console. In television, the foldback mix is valuable for re-recording (looping). With many more monitoring features, and the capability of mono and stereo monitoring, awkward outboard mixers are no longer a necessity.

Pan pots are standard on mono input modules for creative effects. High and low pass filters can be useful in cleaning up poor recordings. Channel input equalizers provide up to 12 dB of boost or cut at 6 selectable frequencies.

An 11 position input gain trim provides an additional 40 dB attenuation or 25 dB boost to handle unexpected input level variations, and accommodates input levels of -70 to +20 dBm. This feature is available on all mono input modules.

Complementing the monitor system, a full input SOLO system permits preview of all inputs for cueing with far greater flexibility than conventional cue systems. Control room monitor speakers are automatically switched when a SOLO button is depressed with the SOLO feed on the left speaker, and the monitor feed on the right speaker ducked to an adjustable level.

CONSOLE MAIN FRAME

The M90 main frame provides housing for all modules, terminations, and interconnections required in the console. The all

aluminum enclosure is furnished with walnut formica sides. The system concept is one using a motherboard with plug-in modules containing amplifiers and associated items. Behind the hinged meter panel are plug-in line output amplifier cards used as outputs for program, echo send, monitor and foldback.

The main frame is exceptionally rugged, and lightweight enough to be practical in portable applications. Blank space on the meter panel can be used for installation of digital clocks or other accessories, and space is available in the console trough for installation of tape remote controls, etc.

An illuminated VU meter appears for each of the 2, 4 or 8 program outputs in the console.

The main frame motherboard will accept input modules with or without EQ in any of the input positions. Unused positions are covered with optional matching blank panels. Positions to the extreme right are allocated to monitor and master control modules.

A fully protected rack-mount power supply is provided. Designed to work from 230 or 115 volt AC, 40-60 Hz line source, it is

regulated and protected against over voltage, excessive current, and line voltage variations. Power drain is less than 100 watts. A current limited, fully protected 48-volt phantom microphone power supply, wired to microphone inputs, is included for central powering of condenser microphones while retaining dynamic microphone compatibility.

TYPICAL INPUT

A typical mono input position provides a conductive plastic linear motion attenuator and stepped sensitivity or trim control to accommodate levels from -70 dBm to +20 dBm. An optional 3 knob, 6 frequency equalizer provides 12 dB boost or cut at 80 Hz or 150 Hz, 1.8 kHz or 4 kHz, and 7.5 kHz or 12 kHz; In/Out switch with LED indicator; plus Hi-Lo filters.

Switch selection between two inputs which may be either microphone or line level is included. Solo function with LED indicator at each position may be used without interruption of program. A simple strapping change on the input module PC board permits altering solo function to a pre-fader cue function if desired. An On-Off switch with LED indicator and controls for echo send A and B appear on each mono input.

PERFORMANCE SPECIFICATIONS

(subject to change without notice)

Frequency response:	±1 dB 20-20,000 Hz, measured any input to any output at any level up to +18 dBm out.
Noise:	Measured from any microphone input to any output channel is not less than 74 dB below +4 dBm output, with a -50 input, nominal gain settings, 20-20,000 Hz unweighted. Measured from any line input to any output channel is not less than 80 dB below +4 dBm output, with +4 dBm input, nominal gain settings, 20-20,000 Hz unweighted.
Distortion:	THD less than 1/10 of 1%, 30-20,000 Hz at any level up to +18 dBm output. Less than 5/10 of 1% 30-15,000 Hz at levels +18 to +24 dBm output. Measured any input to output. IM distortion less than 0.1% at +18 dBm output.
Crosstalk:	Not in excess of -80 dBm at 1,000 Hz and -65 dBm at 10,000 Hz. Measured worst case condition, any input to any output, adjacent busses.
Maximum Output Level:	+24 dBm, transformer isolated.

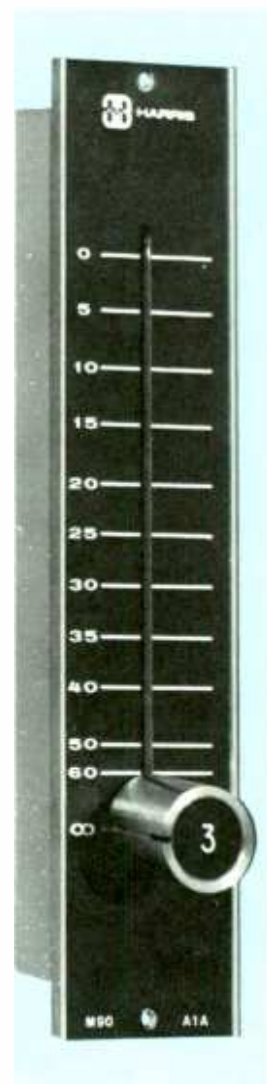

Penny & Giles conductive plastic linear motion faders with optional cue position are used for input channel and master gain controls.

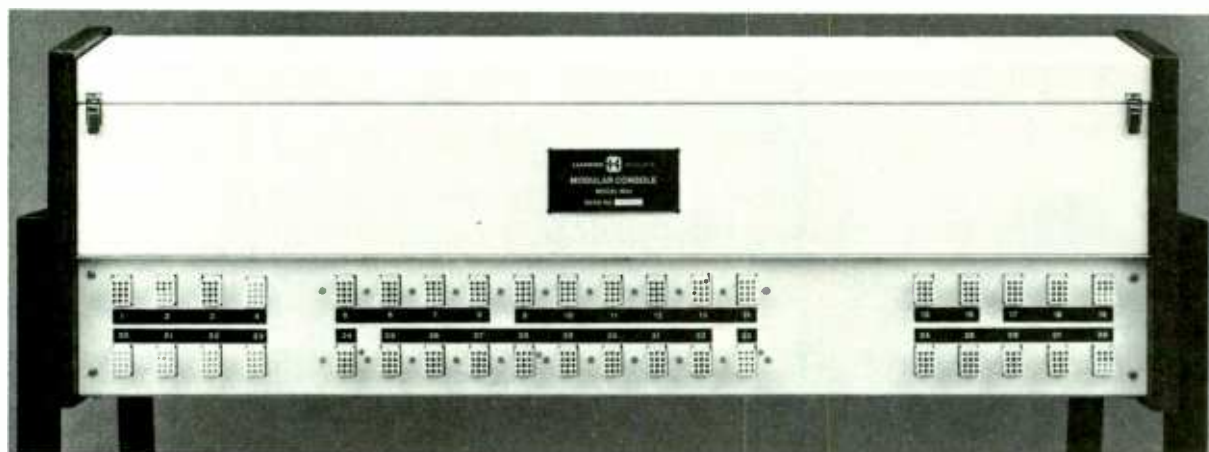

Rear view, M90, showing input and output connections through standard multi-pin connectors. XLR connectors are optional.

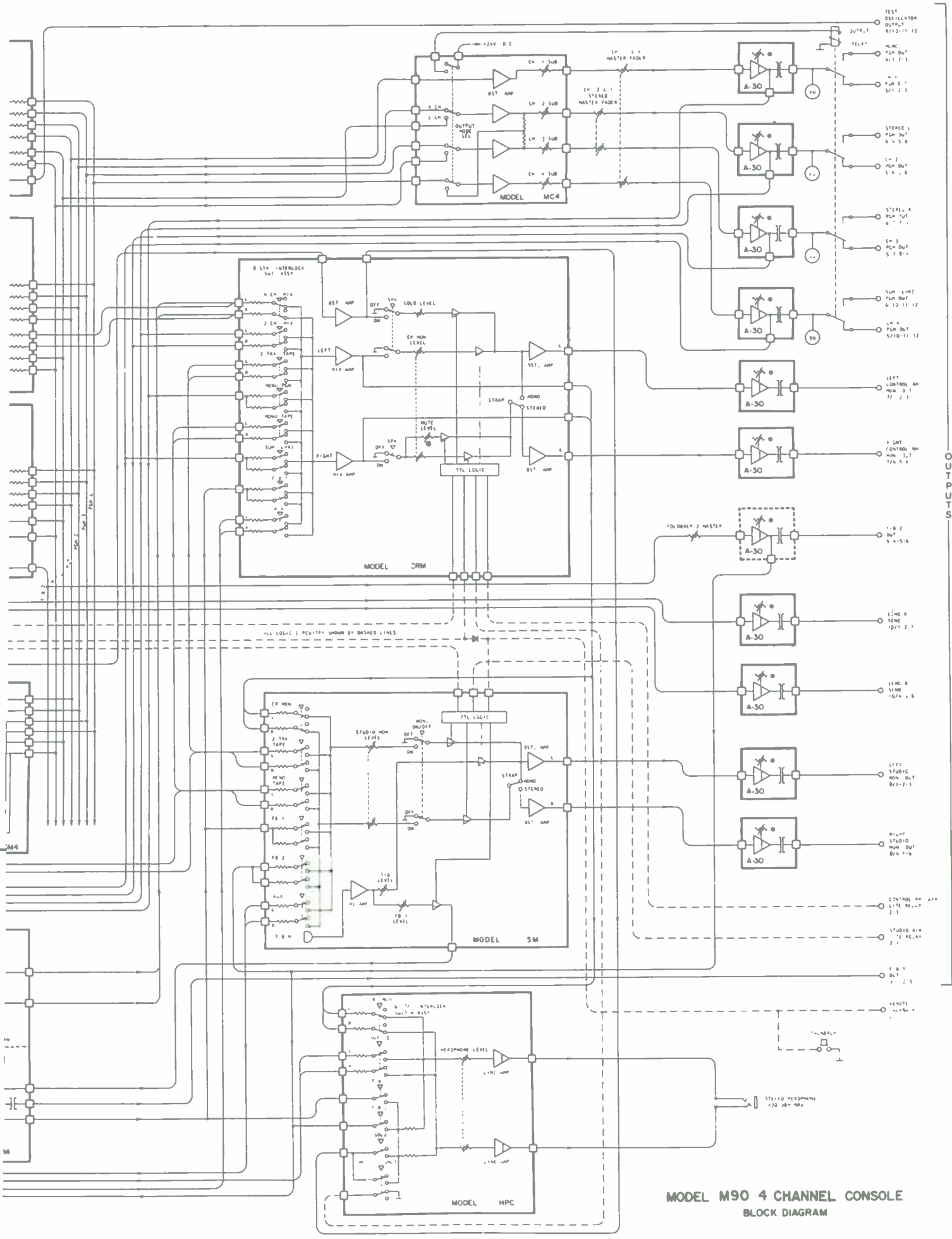

OUTPUTS

**MODEL M90 4 CHANNEL CONSOLE
BLOCK DIAGRAM**

HARRIS' M90 MODULAR AUDIO CONSOLE MAIN FRAME AND MODULES

The following listings cover the major components available to customize the M90 audio console to your own requirements. Order numbers are listed in parentheses following the descriptions. A complete chart of these components is shown on the following two pages for your ordering convenience.

MAIN FRAMES

The M90 series includes many configurations of main frames involving three sizes—all constructed of heavy aluminum extrusions. Each main frame is supplied with support legs to make it free standing or it may be flush mounted in a desk or table top.

All plug-in modules and components, with the exception of the power supply, are housed in the main frame. Signal interconnect, logic and power distribution for all modules is provided by a motherboard. Patch points, input and output terminations are located at the back of the main frame through multi-pin connectors; however, XLR terminations are also available.

M90-2MF TWO CHANNEL OUTPUT MAIN FRAME (MAXIMUM 18 FADERS).

Main frame for 2 channel output console. Includes a master fader, master control module (MC2), talkback switch (TBS), 3 line amplifiers (A30), 2 VU meters, power supply, logic circuits and wired for maximum number of inputs. Accommodates up to 18 faders (mono, stereo or combination) and 12 line amplifiers. Size: 38 inches wide, 32½ inches deep and 29½ inches high (floor to padded arm rest). (740-0201-000.)

M90-4MF FOUR CHANNEL OUTPUT MAIN FRAME (MAXIMUM 18 FADERS).

Main frame for 4 channel output console. Same size and facilities as 2 channel output main frame except it is supplied with 4 VU meters and 5 line amplifiers. (740-0202-000.)

M90-4MFS FOUR CHANNEL OUTPUT MAIN FRAME (MAXIMUM 26 FADERS).

Same facilities as 4 channel output main frame except it will accommodate 26 faders. Size: 49½ inches wide, 32½ inches deep and 29½ inches high (floor to padded arm rest). (740-0225-000.)

M90-8MF EIGHT CHANNEL OUTPUT MAIN FRAME (MAXIMUM 24 FADERS).

Main frame for 8 channel output console. Accommodates up to 24 faders (mono, stereo or combinations). Includes a master fader, talkback switches (TBS), 2 master control modules (MC4 and MC8), 1 foldback master control module (FBM), 8 VU meters, and 11 line amplifiers (A30). Frame will house up to 18 line amplifiers. Size: 49½ inches wide, 32½ inches deep and 29½ inches high (floor to padded arm rest). (740-0226-000.)

EXPANDED MAIN FRAMES

Main frames may be expanded on special order to 34 input channels on 2 & 4 output channel consoles; to 32 input channels on the 8 channel console.

MIXING MODULES

The general term "mixing modules" encompasses a wide variety of plug-in modules, both mono and stereo, including faders, input modules (with or without equalization) and bus switching modules.

M90-IME MONO INPUT MODULE WITH 3 SECTION EQUALIZER.

Plug-in mono input module for use in any main frame. On-Off switch with LED indicator. Automatic muting. Two inputs, mic or line, selected by interlocked pushbutton; supplied for 1 mic and 1 line input, but can be easily strapped for 2 mic or 2 line. Gain trim accommodates inputs from -70 to +20 dBm; patch points; switchable High Pass and Low Pass filters independent of equalizers. Solo selected by latching type pushbutton with LED indicated for "Cue" or "Preview", with option for pre-equalizer, pre-fader or post-equalizer, post-fader operation. Three section equalizer—each section fully adjustable and each individually selected by latching pushbutton, and two echo send controls for assigning an adjustable portion of the module output to either one or both of two "Echo" or effects busses. (740-0206-000.)

M90-IM INPUT MODULE (NO EQUALIZER). Same as M90-IME module, but less the 3 section equalizer. (740-0207-000.)

M90-SIM STEREO LINE LEVEL INPUT MODULE (NO EQUALIZER). Accepts left and right inputs at line level. Has module On-Off switch with LED indicator and provides SOLO feed as a combination of L and R. (740-0208-000.)

M90-SPF4 FOUR CHANNEL BUS AND PAN MODULE WITH FOLDBACK #2.

Used with 4 channel output models only. Provides method of assigning output from mono input module (IME and IM) to any one or all of the four output busses. Also contains PAN pot to feed stereo busses and foldback On-Off switch and foldback level control. (740-0210-000.)

M90-SPF2 TWO CHANNEL BUS ASSIGN AND PAN MODULE WITH FOLDBACK #2. Performs same function as M90-SPF4 module, but for use with 2 channel output console. (740-0213-000.)

M90-8SPF8 EIGHT CHANNEL BUS ASSIGN AND PAN MODULE WITH FOLDBACK #2 MIX. Performs same function as M90-SPF4 module, but for use with 8 channel output console. (740-0230-000.)

M90-SSM4 STEREO BUS ASSIGN MODULE — FOUR CHANNEL. Used with 4 channel output models only. Assigns left and right output from stereo input module (SIM) to output busses. (740-0211-000.)

M90-SSM2 STEREO BUS MODULE — TWO CHANNEL. Same function as M90-SSM4 module, but used only with 2 channel output models. (740-0214-000.)

MONITORING MODULES

Ten different monitoring modules are available, offering relatively simple to very extensive monitoring for both loudspeakers and headsets.

M90-CRM CONTROL ROOM MONITOR MODULE.

This is a basic monitor select and control module for 2 and 4 channel output consoles. Facilities include: mono or stereo operation; monitor level control; separate pushbutton switches for on-off operation of left and right control room speakers; 8 position interlocked pushbutton switch providing monitor inputs from 4 channel mix, 2 channel program, 2 track tape, mono program, mono tape, sum (L+R), foldback and auxiliary; LED indicators for control room mic and SOLO and SOLO bus level control. (740-0203-000.)

M90-8CRM CONTROL ROOM MONITOR MODULE FOR 8 CHANNEL OUTPUT CONSOLE.

Same operation as M90-CRM module, but used only with 8 channel output console. (740-0227-000.)

M90-SM STUDIO MONITOR MODULE.

Used with 2 and 4 channel output consoles. Provides the source for left and right studio monitoring speakers. Facilities include: level controls for monitor, talkback and foldback; talkback microphone; LED warning light for live studio microphone; manual pushbutton switch for studio muting with LED indicator and 6 position pushbutton switch for feeding studio monitor from: control room monitor, 2 track tape, mono tape, foldback 1 and 2 and an auxiliary input. (740-0204-000.)

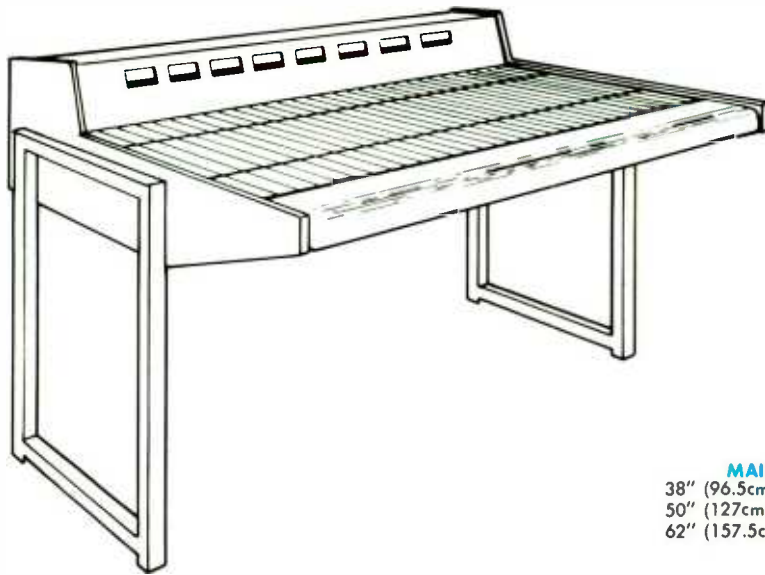

**M90 CONSOLE
MAIN FRAME**

MAIN FRAME WIDTHS

38" (96.5cm) for 18x2 or 18x4
 50" (127cm) for 26x4 or 24x8
 62" (157.5cm) for 34x4 or 32x8

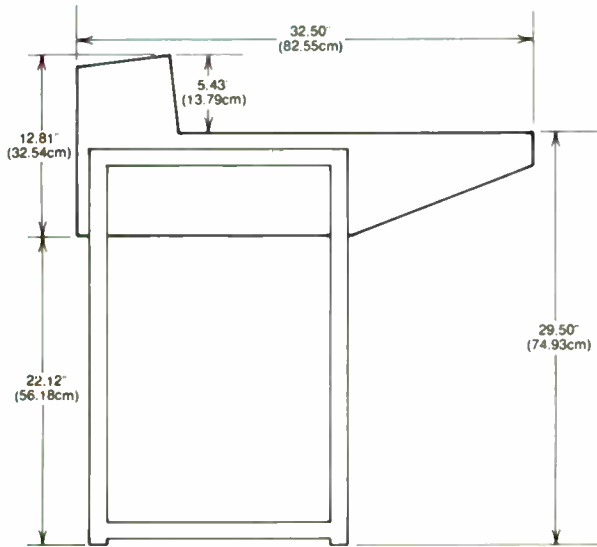

-SIDE VIEW-

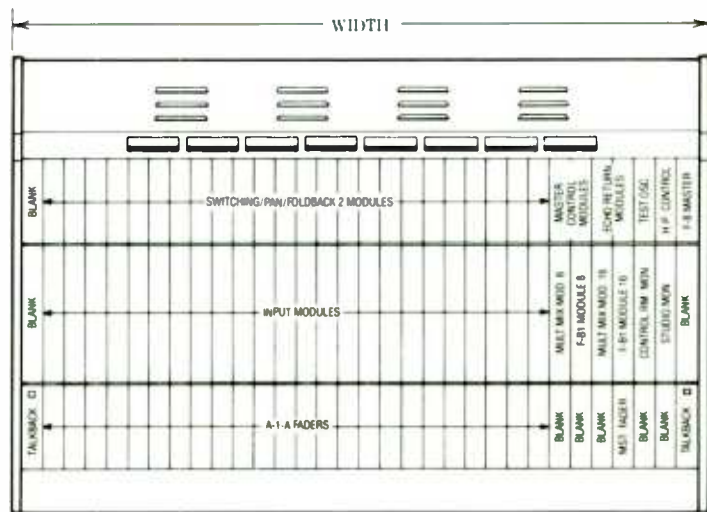

-TOP VIEW-

M90-8SM STUDIO MONITOR MODULE—8 CHANNEL. Provides same functions as M90-SM module, but used only with 8 channel output console. (740-0228-000.)

M90-HPC STEREO HEADPHONE CONTROL MODULE. Contains headphone level control and 6 position pushbutton switches, permitting headphone monitoring of: control room monitor, SOLO, foldback 1 and 2, and auxiliary inputs. (740-0218-000.)

M90-FM4 FOUR CHANNEL FOLDBACK #1 AND MONITOR MIX MODULE. This module is employed mainly in overdub recording where it is necessary to feed the performer a foldback mix from up to four sources at a different mix ratio than the control room operator. (740-0217-000.)

M90-8FB1/8 FOLDBACK 1 MIX MODULE. (740-0231-000.)

M90-8FB1/16 FOLDBACK 1 MIX MODULE. (740-0232-000.)

M90-8MM 8 MONITOR MIX MODULE. (740-0233-000.)

M90-8MM 16 MONITOR MIX MODULE. (740-0234-000.)

The four modules above perform the same function as the M90-FM4, but apply to 8 channel output operation.

SPECIAL PURPOSE MODULES

M90-TO TEST OSCILLATOR MODULE — 2/4 CHANNEL OUTPUT. This module provides 8 fixed frequency sine waves from 50 Hz to 15 kHz for level setting plus a pushbutton operated 30 Hz slate tone. The output may be directed by pushbutton switches to the 2 or 4 channel mixing busses. (740-0220-000.)

M90-8TO TEST OSCILLATOR MODULE—8 CHANNEL OUTPUT. Performs same function as M90-TO module, but applies to 8 channel output operation. (740-0235-000.)

M90-ERM ECHO RETURN ASSIGN MODULE PROGRAM AND MONITOR—2/4 CHANNEL OUTPUT. This module allows the assignment of the echo return (delayed audio, reverb or special effects) to any one or all of the mixing busses. Echo return may also be directed only to the monitor circuit. Echo master gain control and pan control is also included. (740-0205-000.)

M90-8ERM ECHO RETURN ASSIGN MODULE PROGRAM AND MONITOR—8 CHANNEL OUTPUT. Performs same function as M90-ERM module, but applies to 8 channel output operation. (740-0229-000.)

ORDER NO.	TYPE NO.	DESCRIPTION
740-0201-000	M90-2MF	2 CHANNEL OUTPUT MAIN FRAME (18 input pos. max.)
740-0305-000	M90-2MFX	2 CHANNEL OUTPUT MAIN FRAME with XLR CONNECTORS
740-0213-000	M90-SPF2	2 CHANNEL BUS ASSIGN & PAN MODULE with FOLDBACK #2 *1
740-0214-000	M90-SSM2	2 CHANNEL BUS ASSIGN with STEREO SWITCHING *2
740-0202-000	M90-4MF	4 CHANNEL OUTPUT MAIN FRAME (18 input pos. max.)
740-0306-000	M90-4MFX	4 CHANNEL OUTPUT MAIN FRAME with XLR CONNECTORS
740-0225-000	M90-4MFS	4 CHANNEL OUTPUT MAIN FRAME (26 input pos. max.)
740-0307-000	M90-4MFSX	4 CHANNEL OUTPUT MAIN FRAME with XLR CONNECTORS
740-0210-000	M90-SPF4	4 CHANNEL BUS ASSIGN & PAN MODULE with FOLDBACK #2 *1
740-0211-000	M90-SSM4	4 CHANNEL BUS ASSIGN with STEREO SWITCHING *2
740-0206-000	M90-IME	INPUT MODULE with EQ and ECHO SEND *1
740-0207-000	M90-IM	INPUT MODULE with ECHO SEND (no EQ) *1
740-0208-000	M90-SIM	INPUT MODULE, STEREO (no EQ or ECHO SEND) *2
740-0517-000	M90-F1	LINEAR MOTION FADER, MONO *1
740-0519-000	M90-F2	LINEAR MOTION FADER, STEREO *2
740-0203-000	M90-CRM	CONTROL ROOM MONITOR MODULE *3
740-0204-000	M90-SM	STUDIO MONITOR MODULE *3
740-0218-000	M90-HPC	HEADPHONE CONTROL MOUDLE (includes amplifiers)
740-0205-000	M90-ERM	ECHO RETURN MODULE *4
740-0219-000	M90-A30	LINE OUTPUT AMPLIFIER, PLUG-IN
740-0220-000	M90-TO	TEST OSCILLATOR MODULE
740-0241-000	M90-EX6	EXTENDER MODULE, 6"
740-0242-000	M90-EX9	EXTENDER MODULE, 9"
740-0236-000	M90-BK	BLANK PANEL SET, INPUT POSITION
740-0315-000	M90-IS4M	4-POSITION INPUT SELECTOR, MONO *1
740-0316-000	M90-IS4TM	4-POSITION INPUT SELECTOR, MONO TRAY MOUNTED *1
740-0317-000	M90-IS4S	4-POSITION INPUT SELECTOR, STEREO *2
740-0318-000	M90-IS4TS	4-POSITION INPUT SELECTOR, STEREO TRAY MOUNTED *2
740-0325-000	M90-IS8S	8-POSITION INPUT SELECTOR, STEREO PUSHBUTTON *2
740-0238-000	M90-TRC	TAPE TRANSPORT SWITCH, ILLUMINATED PUSHBUTTON
740-0337-000	M90-ENG	ENGRAVED CHARACTERS on switches, etc.
740-0217-000	M90-FM4A	4 CHANNEL FOLDBACK #1 & MONITOR MIX MODULE
740-0319-000	M90-OMM	4 CHANNEL to MONO MIX DOWN MODULE
740-0313-000	M90-VUB	VU METER with BUFFER AMP (installed at time of manufacture)
740-0263-000	M90-DC	DIGITAL CLOCK (installed at time of manufacture)
740-0264-000	M90-DT	DIGITAL TIMER (installed at time of manufacture)
740-0265-000	M90-QS	CUE SPEAKER & AMPLIFIER (installed at time of manufacture)
740-0243-000	M90-30MS	SPARE POWER SUPPLY, 115/230 VOLT
740-0239-000	M90-PB	PATCH BAY with DESK CABINET (rear connectors)
740-0226-000	M90-8MF	8 CHANNEL OUTPUT MAIN FRAME (24 input pos. max.)
740-0308-000	M90-8MFX	8 CHANNEL OUTPUT MAIN FRAME with XLR CONNECTORS
740-0230-000	M90-8SPF8	8 CHANNEL BUS ASSIGN & PAN MODULE with FOLDBACK #2 *1
740-0309-000	M90-8SSM	8 CHANNEL BUS ASSIGN with STEREO SWITCHING *2
740-0227-000	M90-8CRM	CONTROL ROOM MONITOR MOUDLE *3
740-0228-000	M90-8SM	STUDIO MONITOR MODULE *3
740-0229-000	M90-8ERM	ECHO RETURN MODULE *4
740-0323-000	M90-8HPC	HEADPHONE CONTROL MODULE (includes amplifiers)
740-0235-000	M90-8TO	TEST OSCILLATOR MODULE
740-0231-000	M90-8FB1/8	8 FOLDBACK #1 MIX MODULE
740-0233-000	M90-8MM8	MONITOR MIX MODULE

*1 Use in MONO input positions

*2 Use in STEREO input positions

*3 Requires 1 optional M90-A30 for mono, 2 for stereo

*4 Requires 1 optional M90-A30 Line Output Amplifier



HARRIS

M90

Modular Audio

On-Air

Console

(Supplement to M90 Modular
Audio Control Console Brochure)

- Program stereo output, Audition stereo output, plus selectable PGM or AUD sum channel
- Simple stereo bus assign pushbutton switches
- Monitor selector switches for typical broadcast functions (PGM, AUD, AIR, etc.)
- Multiple studio speaker muting
- Available with 18 or 26 input channels
- Incorporates most of the features of the M90 two, four and eight output channel consoles

The Harris M90 ON-AIR audio console is an extremely versatile, highly flexible dual stereo modular unit with a selectable sum channel output. The console is available with an 18 or 26 input mainframe to mount the plug-in modules required for your operation. Except for the output bus switching and monitoring modules, most of the standard M90 modules can be installed in your M90 ON-AIR console to customize your board to your exact requirements.



Designed specifically for on-air use, the modules described below feature simplified switching and ease of operation. The additional modules needed to complete your on-air console configuration are covered in our eight-page M90 Modular Audio Control Console brochure.



M90-SS4B



M90-SSP4B

The M90-SS4B PGM/AUD Bus Assign Module is used in stereo input channels with associated M90-SIM Input and M90-A2A Fader Modules. These three units are required for each stereo input channel. An engaged switch button will release when the other one is actuated on the M90-SS4B Module.

The M90-SSP4B PGM/AUD/PAN Bus Assign Module is similar to the M90-SS4B Module except for the pan pot. This is used to feed a mono input to the stereo output busses, panning the signal from stereo left to center to stereo right. An associated M90-IME or M90-IM Input and M90-A1A Fader Module completes a mono input channel.

The M90-MS4B Master Control Module contains recessed screwdriver adjustable program and audition stereo controls (individual left and right), a pushbutton selector to feed the sum channel from the program or audition outputs, and the sum gain control. The screwdriver pots provide for initial setup and discourage operator changes. The Mono PGM, or sum gain control, can be adjusted by the operator for center buildup and other summing problems. (Supplied with mainframe.)

The M90-HPCB Headphone Control Module has a 6-position input selector with a unique feature on the top pushbutton. This pushbutton interrupts the cue feed into the



M90-MS4B



M90-HPCB

M90-CRMB Module and the control room speaker muting. The second cue position permits normal control room monitoring. Mix A and Mix B are feeds from the optional line amps in the Mix A and B send circuits. (Supplied with mainframe.)

The M90-CRMB Control Room Monitor Module has the input selectable to console output channels, air feed, network feed and an auxiliary input. Other facilities include: mono or stereo operation; monitor level control; and separate pushbutton switches for on-off operation of left and right control room speakers. (Supplied with mainframe.)



M90-CRMB



M90-SMB

The M90-SMB Studio Monitor Module has all but Mix A and Mix B inputs appearing on the M90-CRMB Module. It contains a high quality studio talkback microphone that is ac-

tuated by a switch located on the extreme right panel in the fader row. An external talkback microphone may be used if desired. A studio speaker feed ON/OFF switch and LED indicator provide additional operator control. In addition to the studio monitor level control, there are talkback level controls for studio speakers and foldback-1.

The studio talkback feeds into the left studio speaker with appropriate muting control. Foldback-1 is seldom used in an air board, but the feed is available for any special requirement. The Mix A and Mix B outputs may be used for any special requirements as well. They are available from mono input channels only.

Other optional items such as the digital timer, digital clock, cue amplifier and speaker can be obtained in the M90 ON-AIR Console. The cue function in this board replaces the solo function in the other M90 consoles, and the input and monitoring modules have the function designated as "cue" on the module panels. There is no reason to add the cue amplifier and speaker to the M90 consoles unless a different quality of sound is desired for cue than that obtained from the control room monitor speaker. The cue circuits are connected into the left control room speaker in boards without the cue amplifier.

A studio muting card is available for any of the M90 consoles with two individual muting relay driver circuits for external relays. 24-volt power for the relays is taken from the M90 power supply. Several M90-RSM Remote Studio Muting Cards may be mounted in the M90 cabinet with the relay coil connections appearing on rear panel plugs.

The very logical placement of the M90 modules, and the controls on the modules, make this board comfortable for the operator almost immediately after he sees it for the first time. Yet it has all the versatility and flexibility found on highly complicated looking boards.

Improve your operation with an M90 ON-AIR Console!

ORDERING INFORMATION

Order No.	Description
740-0326-000	M90-4MFB Mainframe, 5 VU meters, 18 input channels
740-0336-000	M90-4MFSB Mainframe, 5 VU meters, 26 input channels
740-0328-000	M90-SS4B Module
740-0329-000	M90-SSP4B Module
740-0332-000	M90-SMB Module
740-0330-000	M90-RSM Card



HARRIS

EXECUTIVE

10-Channel Stereo Audio Control Console

- 10 full-stereo mixing channels
- 29 inputs to the mixers
- All solid-state plug-in amplifiers
- Low distortion
- Excellent frequency response
- Provision for plug-in sum channel amplifier

The Executive is one of the most versatile audio consoles available today, offering 29 inputs into 10 full-stereo mixing channels. This highest-quality console offers excellent audio performance, and has built a solid reputation for long-term reliability. In addition, the board layout has been "human engineered" to provide great operating convenience.

MIXING SYSTEM: This ten-channel stereo mixer utilizes low impedance ladder type controls in a parallel, minimum loss type, mixing circuit.

MICROPHONE CHANNELS: Three microphone channels can be individually switched from the front panel to either full stereo operation or fully isolated monophonic feed from one microphone into the stereo mixer. There are two separate preamplifiers in each of the three microphone channels, operated in parallel for stereo use. The second preamplifier is bridged off the first when a single microphone is used to feed the stereo program, simplifying disc jockey, control room or news room microphone insertions.



Microphone transfer switches are located immediately above the microphone mixing channels for instantaneous changes in programming requirements. A second switch for each microphone channel allows the selection of two sets of stereo microphones into each of the three channels. This permits the use of six sets of stereo microphones without patching.

TURNTABLE CHANNELS: Channels 4 and 5 have switching to accommodate four turntables into either channel in any sequence. A cue position on these two channels permits cueing in the channel not in use.

TAPE CHANNELS: Channels 6 and 7 have switching to accommodate four tape machines into either channel in any sequence. There is a cue position on channels 6 and 7 to permit previewing and cueing of all recorder material before feeding it to the transmitter.

REMOTE CHANNEL: Four remote lines are switched into channel 8 when mixed into either stereo or monophonic programming. The stereo mixer in channel 8 has a splitting pad on the input to permit feeding a monophonic source to both sides of the stereo mixer.

NETWORK CHANNEL: Channel 9 is the network channel. It is also a stereo mixer with a splitting pad on the input, since most network facilities are monophonic at the present time. Should this condition change, you simply remove the splitting pad and the full stereo facilities are restored. An occasional stereo network program could be patched into one of the stereo channels. A cue position permits previewing the network, then smoothly fading it into the program channel.

AUXILIARY CHANNEL: Channel 10 is the auxiliary channel, with two isolation transformers on the input of the stereo mixer to prevent any interaction or grounding problems with almost any input source.

CUE-INTERCOM SYSTEM: The cue-intercom system provides flawless network monitoring, remote over-

ride, remote talk-back, studio intercom, turntable cueing, tape cueing and general previewing and cueing on all but the microphone channels. The control room and studio speakers are muted by the channel keys and muting relays when there is a live microphone in any of these locations.

The cue signals from channels 4 through 10 are fed into the cue-intercom amplifier regardless of the position of the cue selector switch.

PROGRAM SWITCHING FUNCTIONS: One front panel switch changes the master operation of the Executive console from stereo to simultaneous or separate operation, as desired by the operator. Stereo program busses and stereo audition busses are designated: "Program Left," "Program Right," "Audition Left," and "Audition Right." The "Program Left" bus is permanently connected to the "Master Left" channel.

In the STEREO position, the input of the "Master Right" channel is connected directly to the "Program Right" bus. Thus, each half of the dual attenuators feeds through a program amplifier to the stereo output line.

If the optional program amplifier is used during stereo programming, its input is bridged across the output of both the "Master Left" and "Master Right" channels. The output of the optional amplifier is then equal to L+R, the compatible stereo signal, and may be used to feed an AM transmitter.

In the SIMULTANEOUS position, the input of the "Master Right" channel is bridged off the output of the "Master Left" channel. This allows simultaneous programming of an AM and FM transmitter. If the optional program amplifier is used, its input can also bridge the output of the "Master Left" channel for simultaneous feed.

In the SEPARATE position, the input of the "Master Right" channel for the optional program amplifier is connected to the "Audition Left" bus, so

separate programming may be fed to the AM and FM transmitters.

The left hand VU meter is connected to the output of the "Master Left" channel at all times. This is the "Left" channel in stereo programming. The right hand meter can also be switched to the output of the "Master Left" channel for a calibration check. It may also be switched to the output of the "Master Right" channel for stereo metering. In addition, it may be switched to the output of the optional program amplifier to check the level of the compatible stereo, or separate programming, to the AM transmitter. The next position on this switch connects the meter to the network feed to check the level of the network at any time. The last position is for external measurements.

STEREO MONITORING AMPLIFIERS: Two 8 watt amplifiers are built in the Executive for complete stereo monitoring. An input switch on the stereo monitoring amplifiers permits them to be connected to the output of the master channels, the output of the audition bus booster amplifiers, or to an external stereo input. Two sets of muting contacts on each relay permit muting of the stereo speakers—in the control room and the studios. These relays are completely encased, and plug-in for complete reliability and maintenance.

TRANSISTOR AMPLIFIERS: The Executive stereo console is completely transistorized. All amplifiers are plug-in type, with the exception of the stereo monitor amplifiers. The standard amplifier complement consists of:

- 6 preamplifiers (3 pairs for stereo)
- 2 booster amplifiers (1 pair for stereo)
- 2 program amplifiers (1 pair for stereo)
- 2 monitor amplifiers (1 pair for stereo)
- 1 cue-intercom amplifier

In addition, there is the regulated transistorized power supply and provisions for a third compatible program amplifier.

EXECUTIVE CONSOLE

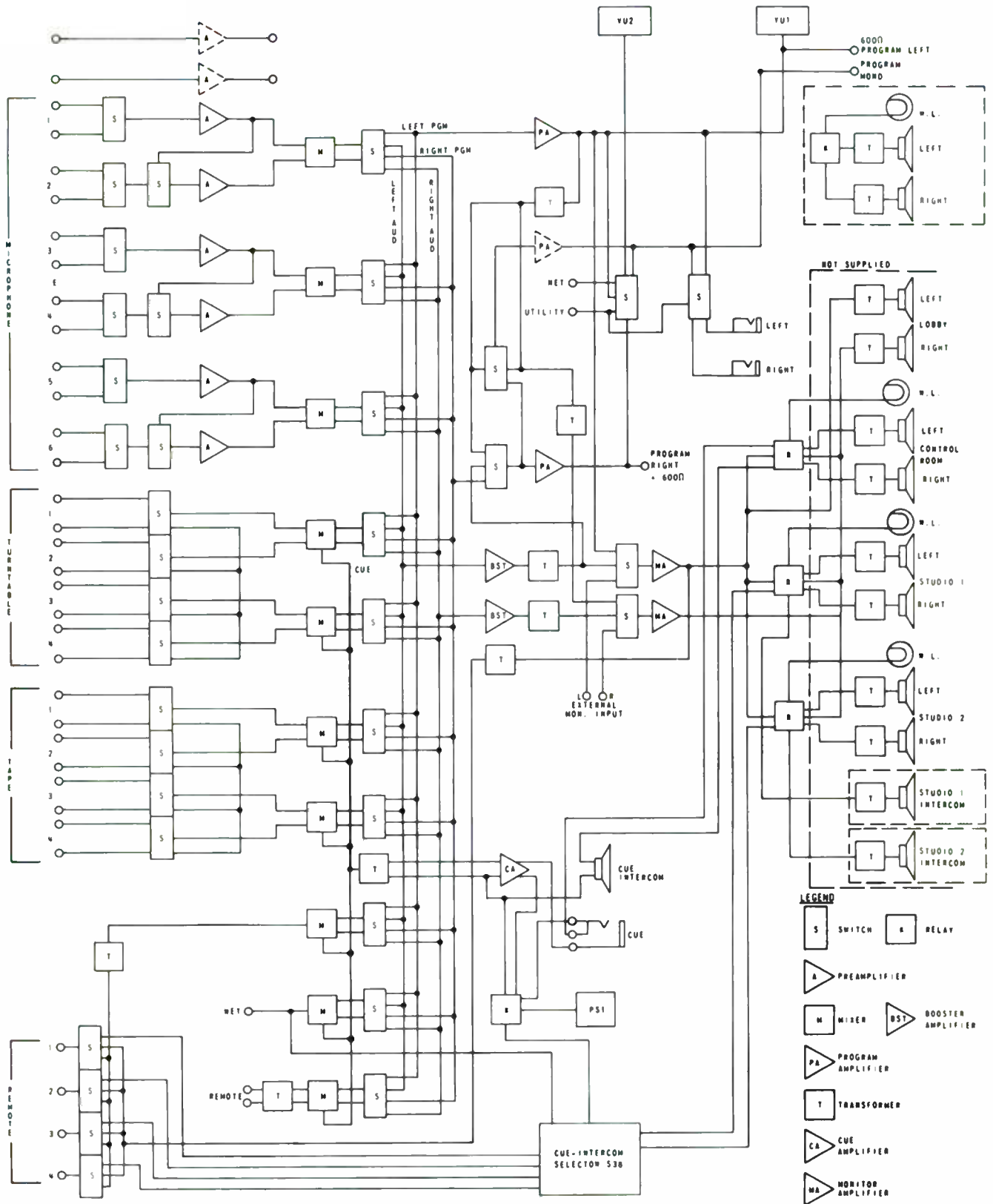

BLOCK DIAGRAM

- LEGEND**
- S SWITCH
 - A PREAMPLIFIER
 - M MIXER
 - PA PROGRAM AMPLIFIER
 - T TRANSFORMER
 - CA CUE AMPLIFIER
 - MA MONITOR AMPLIFIER
 - R RELAY
 - BST BOOSTER AMPLIFIER

EXECUTIVE SPECIFICATIONS

MIXING CHANNELS:

- 12 Full stereophonic each with stereo low impedance ladder attenuator.

INPUTS:

- 12 Stereo microphones to 6 preamps.
- 9 Stereo turntables, tape and projector inputs into 5 stereo mixers.
- 4 Remotes into 1 stereo mixer.
- 1 Individual stereo network channel.
- 3 Stereo monitor inputs.

OUTPUTS:

- 3 Program lines:
 - 2 Stereo program lines—simultaneous or stereo.
 - 1 Monophonic compatible or independent program line.
- 8 Stereo muted monitor outputs.
- 2 Stereo unmuted monitor outputs.
- 4 Stereo recording outputs.
- 10 or more Stereo speaker outputs.
- 2 Interlocked studio intercom outputs.
- 2 Headphone outputs.

AMPLIFIERS:

- 10 Plug-in transistor preamplifiers.
 - 6 microphone preamplifiers.
 - 2 Optional microphone preamplifiers (where ordered).
 - 2 Booster amplifiers.
- 3 Plug-in transistor program amplifiers.
 - 2 Program amplifiers feeding stereo/simultaneous outputs.
 - 1 Optional compatible or independent.
- 1 Plug-in transistor cue/intercom amplifier.
- 2 Full level transistor monitor amplifiers with ganged level controls.

POWER SUPPLY:

- 1 Full regulated, electronically protected transistor power supply.

GAIN:

Microphone to program line: 102 dB \pm 2 dB, Turntable/tape/projector/remote to program line: 56 dB, \pm 2 dB.
Turntable/tape/projector/remote to speaker output: 70 dB.

FREQUENCY RESPONSE:

(Typical) \pm 1.5 dB from 20 to 20,000 Hz in all regular program circuits.
 \pm 1.0 dB from 30 to 15,000 Hz in all regular program circuits.
(Typical) \pm 2.0 dB from 20 to 20,000 Hz in all monitor speaker circuits.
 \pm 1.5 dB from 30 to 15,000 Hz in all monitoring speaker circuits.

HARMONIC DISTORTION:

(Typical) 0.5% Maximum, 20 to 20,000 Hz at +8 dBm output in program circuits.
0.5% maximum, 30 to 15,000 Hz at +8 dBm output in program circuits.
0.5% maximum, 50 to 15,000 Hz at +18 dBm output in program circuits.
(Typical) 1.0% Maximum, 20 to 20,000 Hz at +38 dBm in monitor output circuit.
1.0% maximum, 50 to 15,000 Hz at +39 dBm (8 watts) in monitor output circuit.

INTERMODULATION DISTORTION:

(Typical) 0.5% maximum, 20 to 20,000 Hz at +8 dBm output in all regular program circuits.
0.5% maximum, 30 to 15,000 Hz at +8 dBm output in all regular program circuits.
(Typical) 0.5% maximum, 20 to 20,000 Hz at +18 dBm output in all regular program circuits.
0.5% maximum, 30 to 15,000 Hz at +18 dBm output in all regular program circuits.
(Typical) 1.0% maximum, 20 to 20,000 Hz at +38 dBm in monitor output circuit.
1.0% maximum, 50 to 15,000 Hz at +39 dBm (8 watts) in monitor output circuit.

SOURCE IMPEDANCE:

Microphones—30/50 or 150/250 ohms.
Turntable/tape/projector/remote/network—600 ohms.

LOAD IMPEDANCE:

All program lines—600 ohms.
Speaker outputs—4 to 16 ohms.
Recording outputs—600 ohms.

NOISE:

—122 dBm equivalent input noise—microphone to program line.

CROSSTALK:

Below noise level in all channels.

STEREO ISOLATION:

Below noise level in all channels.

TRANSISTOR COMPLEMENT:

10 Industrial type totaling 76.

POWER CONSUMPTION:

Approximately 50 watts at 110/117/125 volts, 50/60 Hz.

SIZE & WEIGHT:

53½" long, 11½" high and 17½" deep. 107 lbs. net wt., 220 lbs. domestic, 270 lbs. export, 27 cu. ft.

FINISH:

Satin anodized black nomenclature on natural anodized aluminum background panels, white cabinet, blue trim.

SPECIFICATIONS SUBJECT TO CHANGE WITHOUT NOTICE.

ORDERING INFORMATION

Executive 10-channel transistor stereo audio control console, complete with 2 monitor amplifiers, 6 preamplifiers, 2 booster amplifiers, cue-intercom amplifier, 2 program amplifiers and power supply 994-6158-002
Optional preamplifier 994-6034-001
Optional program amplifier 994-5700-003
Speaker matching transformer 478-0291-000



HARRIS

STEREO 80 8 Channel Audio Control Console

- Eight stereo mixing channels
- Eighteen inputs to the mixers
- High program output capability
- Interchangeable cue, monitor and program amplifiers
- Cue amplifier and speaker built in
- All solid state plug-in amplifiers
- Talkback to and from two studios and remote lines, built in
- Excellent frequency response and low distortion
- Audition output for recording
- Concealed master gain controls



STEREO 80 - Eight Channel Stereo



Harris' Stereo 80 is designed for the FM stereo broadcaster who is looking for great flexibility and superb audio quality. The console features a wide choice of inputs and such outstanding performance specifications as: frequency response, 20 to 20,000 Hz with less than 1 dB variation; and distortion less than 0.5% at all frequencies.

INPUTS: Eighteen inputs may be switched into eight stereo mixing channels to provide a degree of flexibility that will satisfy virtually any stereo requirement. Inputs include five microphones, four turntables, five tapes (cartridge or reel-to-reel), three remotes and network.

MIXING CHANNELS: Channels 1 and 2 are equipped with low-noise preamplifiers, and are to be used with low-impedance, broadcast-type microphones. Each of these stereo channels may select from two different pairs of input signals by means of a front-panel switch.

Channel 3 is also equipped with low-noise preamplifiers, and is also intended for use with low-impedance, broadcast type microphones. This channel has a stereo input and is assigned to the control room since these microphones function as part of the talkback system.

Channels 4, 5, 6 and 7 are all medium level inputs and may be used with stereo turntable preamplifiers, reel-to-reel tape, or cartridge machines. All channels have input transformers whose center taps may or may not be grounded, depending upon the given installation. They are shipped with the center taps ungrounded. A nominal level of -20 dBm or $+4$

dBm at 600 ohms is required. Input pads for the $+4$ dBm are provided on the various tape inputs.

Channel 8 is specifically designed to function with network and remote lines as sources. Various combinations of preview, talkback, and program cue are possible using the front panel switches. A nominal input of at least -20 dBm at 600 ohms is required for remotes and -14 dBm for the network.

All eight channels may be switched to either the program or audition positions to permit independent recording and monitoring of any of the incoming sources without disturbing programming. Channels 4 through 8 have a cue position associated with the channel attenuator which provides signal to the amplified cue system. This signal can be monitored by an internal speaker or external headphones. On Channels 1 and 2, the center position of the program audition key switch provides a microphone cue signal to the cue selector switch. On Channel 3 this position is used with the control room microphones for talkback.

SPEAKER MUTING: A protective system of warning lights and relay speaker muting is provided to prevent acoustic feedback and broadcasting of cue signal when "live" microphones are nearby.

AMPLIFIERS: Each solid-state plug-in amplifier is mounted on a separate printed circuit board, which in turn mounts in a card-rack holder. These modules are as follows: six preamplifier modules, five booster amplifier modules, five output amplifier modules and one power supply regulator panel. Silicon transistors are used to assure the meeting of performance specifications and assure optimum console operation over a wide ambient temperature

Phonic Transistor Audio Console

range. All amplifiers are completely accessible when the top of the console is opened, simplifying maintenance.

Program, cueing and monitor amplifiers all have the same electrical design and construction, and are interchangeable. As a result, two backup program amplifiers are provided as part of the console.

HIGH LEVEL, HIGH FIDELITY OUTPUT: The dynamic range of the preamplifiers will accom-

modate microphone levels to -17 dBm without overload or distortion. The program amplifiers deliver $+32$ dBm output and the monitor amplifiers $+40$ dBm, all with wide frequency response, low distortion and low noise.

STYLING: The Stereo 80 is handsomely styled with satin anodized aluminum front panels, and white Pebble-TeX cabinet. The modern design will complement any control room decor.

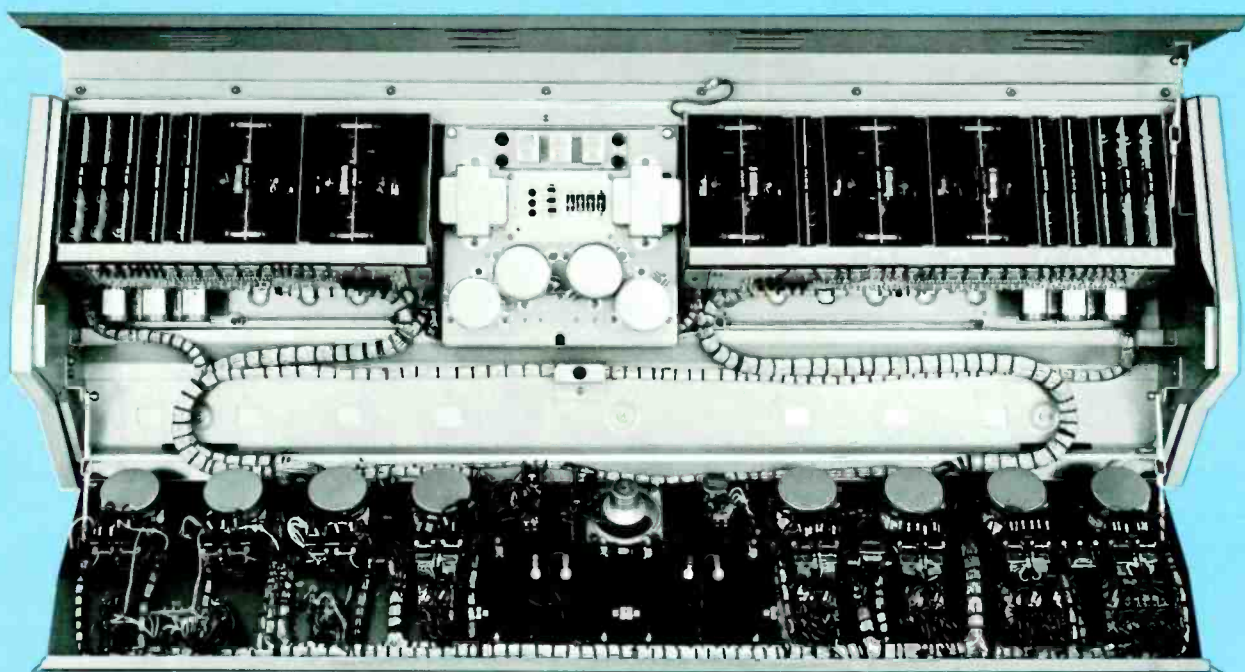

The hinged top of the Stereo 80 raises and the front panel lowers to provide easy access to all console components. The plug-in modular components are easily removed for service.

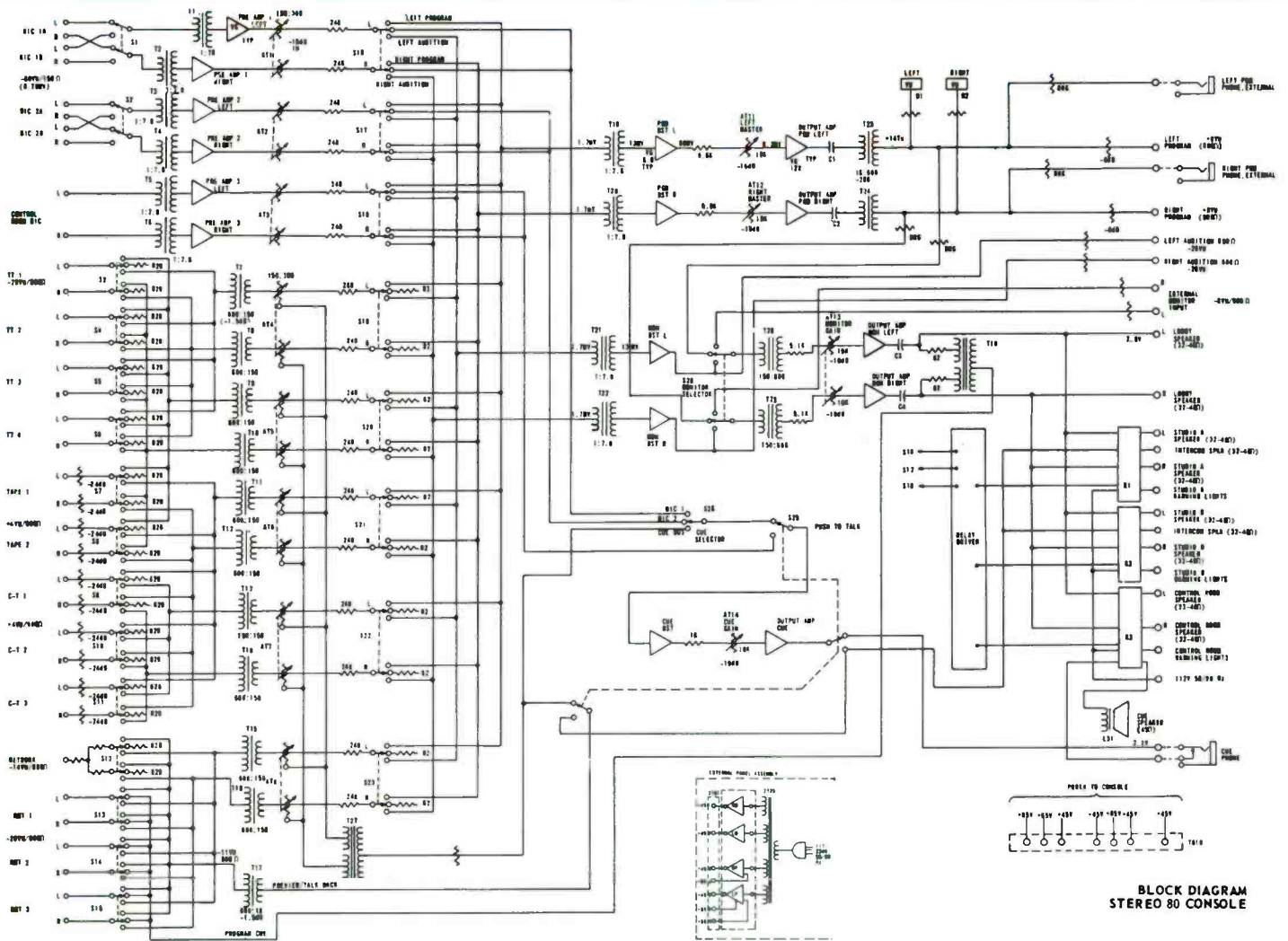

BLOCK DIAGRAM
STEREO 80 CONSOLE

Specifications

Operating Mode: Single output stereo programming with audition positions.

Mixing Channels: Total—8. Three for microphones, two for turntables, two for tapes and one for remote/network.

Input Circuits: Total—18. Five stereo pairs of microphones, four turntables, two tape machines, three cartridge tape machines, three remote lines and one mono network.

Amplifiers and Power Supplies Provided: Six preamplifiers, five boosters, five output modules—program, monitor and cue (interchangeable as supplied). One rack-mount power supply panel.

Output Circuits: One stereo program output @ +8 VU, one stereo audition output @ -26 VU, one monitor speaker pair unmuted for lobby, three monitor speaker pairs muted, one mono and one stereo headphone output.

Monitor Outputs: +40 dBm @ 8 ohm minimum load. Multi-speaker operation should use high impedance speakers (32-45 ohm) or accessory speaker-matching transformer (48/8 ohm) for minimum load of 8 ohms.

Gain: Microphone to line: 100 dB, ± 2 dB. Medium level to line: 60 dB/36 dB, ± 2 dB.

Impedances: Microphones: 150/250 ohms balanced. Turntable/tape: 600 ohms balanced. Network/remote: 600

ohms balanced. Monitor output: 8 ohms nominal unbalanced. Program output: 600/150 ohms balanced. Audition output: 600 ohms built out.

Response: Program: ± 1.0 dB. 20 Hz to 20 kHz. Monitor: 1.0 dB. 30 Hz to 15 kHz.

Distortion: Program circuits: 0.5% maximum, 20 Hz to 20 kHz @ +18 dBm. Monitor circuits: 1.0% maximum, 30 Hz to 15 kHz @ +40 dBm (10 watts).

Noise: Program circuits: 75 dB below +18 dBm with -50 dBV input (-125 dBV equivalent input noise, measured 20 Hz to 20 kHz). Medium level inputs: (program) 78 dB below +18 dBm with -10 dBm input. Monitor circuits: signal/noise = 78 dB below +40 dBm output.

Finish: Satin anodized aluminum panels with lettering in black. Cabinet color... white Pebble-Tex.

Power: 117/234 volts, 50/60 Hz, single-phase. Consumption: 120 watts, maximum.

Mechanical Size: (Console) 45" wide, 15 $\frac{3}{4}$ " deep, 7 $\frac{3}{4}$ " high. Weight: 105 lbs. (Power supply panel) 19" wide, 7 $\frac{3}{4}$ " deep, 7" high. Weight: 21 lbs.

Shipping Data: Packed weight: domestic, 210 lbs.; export, 250 lbs. Cubage: 19 cubic feet.

Specifications subject to change without notice.

Ordering Information

Stereo 80 eight channel stereo console, complete with six preamplifiers; five boosters; five program/monitor/cue output modules (interchangeable); and one power supply panel. 994-6867-001
Speaker matching transformer. 478-0291-000



HARRIS

STEREO 5

Solid-State 5-Channel Stereo Audio Control Console

- Thirteen inputs into five stereo mixing channels
- Compact size saves control room space
- Quiet "push-on/push-off" input switches
- Extensive use of integrated circuits
- All solid state...silicon transistors
- Great versatility at a modest price

Harris' Stereo 5 is a solid-state, stereophonic audio control console that provides a high degree of flexibility through the use of thirteen inputs into five mixing channels. Although compact in size, and economical in price, the Stereo 5 offers facilities and performance specifications comparable to many larger, more expensive consoles.

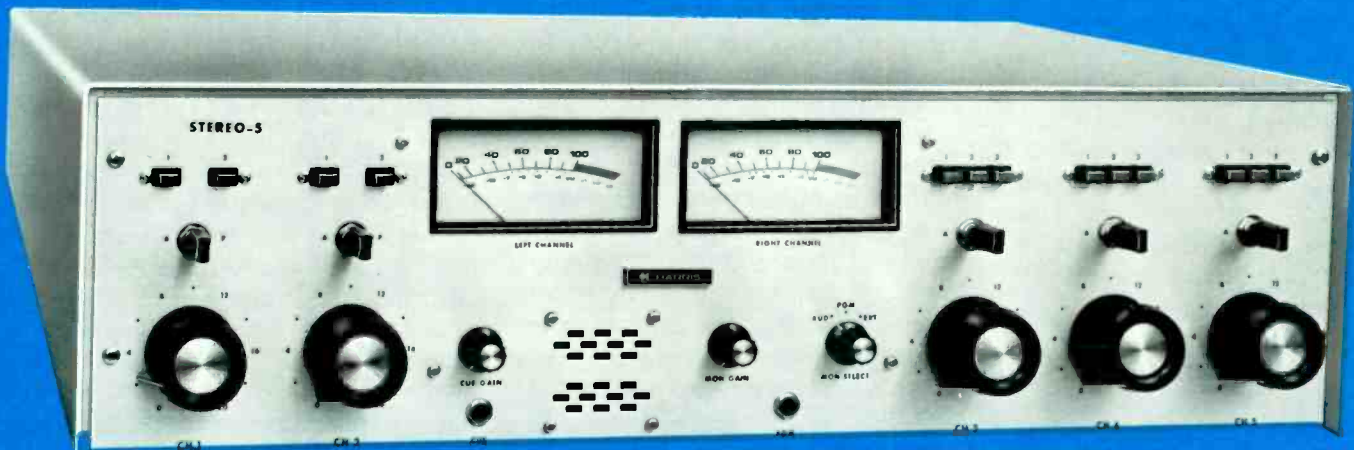



In medium and smaller size FM stereo stations, the Stereo 5 is ideal as a main console. In larger stations, the Stereo 5 will find application as a production console, or may be used for independent programming from a second facility.

VERSATILE INPUT SWITCHING:

Thirteen inputs can be switched into the five mixing channels in a manner to satisfy most stereo programming requirements. These inputs can include four stereo microphone pairs, three stereo turntables, three stereo cartridge reproducers, one stereo reel-to-reel reproducer, one network and one auxiliary stereo source. The thirteen front panel input switches are of the "push-on/push-off" type for quiet control room operation. There are isolation transformers on all program inputs and outputs.

MICROPHONE CHANNELS (1 & 2): These two channels are equipped with low-noise preamplifiers for use with low-impedance, broadcast-type microphones. Each of these channels may select from two different input signals by use of front panel switches.

MEDIUM LEVEL CHANNELS (3, 4 & 5): These three channels are designed for medium level inputs and may be used with turntables, cartridge tape machines, or reel-to-reel machines. Remote, network or auxiliary sources may be assigned to any of the nine medium level inputs.

PROGRAM, AUDITION AND CUE SELECTION:

Any of the five mixing channels may be switched to the Program Channel or Audition to permit independent monitoring or recording of incoming sources without disturbing programming. Channels 3, 4 and 5 also have cue positions, which provide signal to the amplified cue system. This signal can be monitored by an internal speaker or external headphones. Switching is by telephone-grade lever-type keys that provide maximum durability and reliability.

PROGRAM CHANNELS: The left and right program channels are identical--each consisting of a summing type booster amplifier, audio output amplifier, VU meter, and a master gain control. The

master gain control, an internal adjustment, is preset at the factory to provide 16 dB of reserve gain for the console, and is the optimum setting for providing adequate operating margins of signal-to-noise and "headroom". The 4-inch VU meters are standard volume indicators and are used in conjunction with the mixing channel attenuators to establish a reference volume of "0" VU, which is equivalent to an output level of +8 dBm.

ADDITIONAL FACILITIES:

A three-position monitor selector switches the monitoring amplifier input to (1) program circuit, (2) terminals for an external source, and (3) audition circuit. Front panel controls also include monitor gain and cue gain, and conventional high impedance cue and program headset jacks for stereophonic headphones are provided.

A protective system of warning lights and speaker muting is included in the Stereo 5 to prevent acoustic feedback and broadcasting of a cue signal when live microphones are nearby.

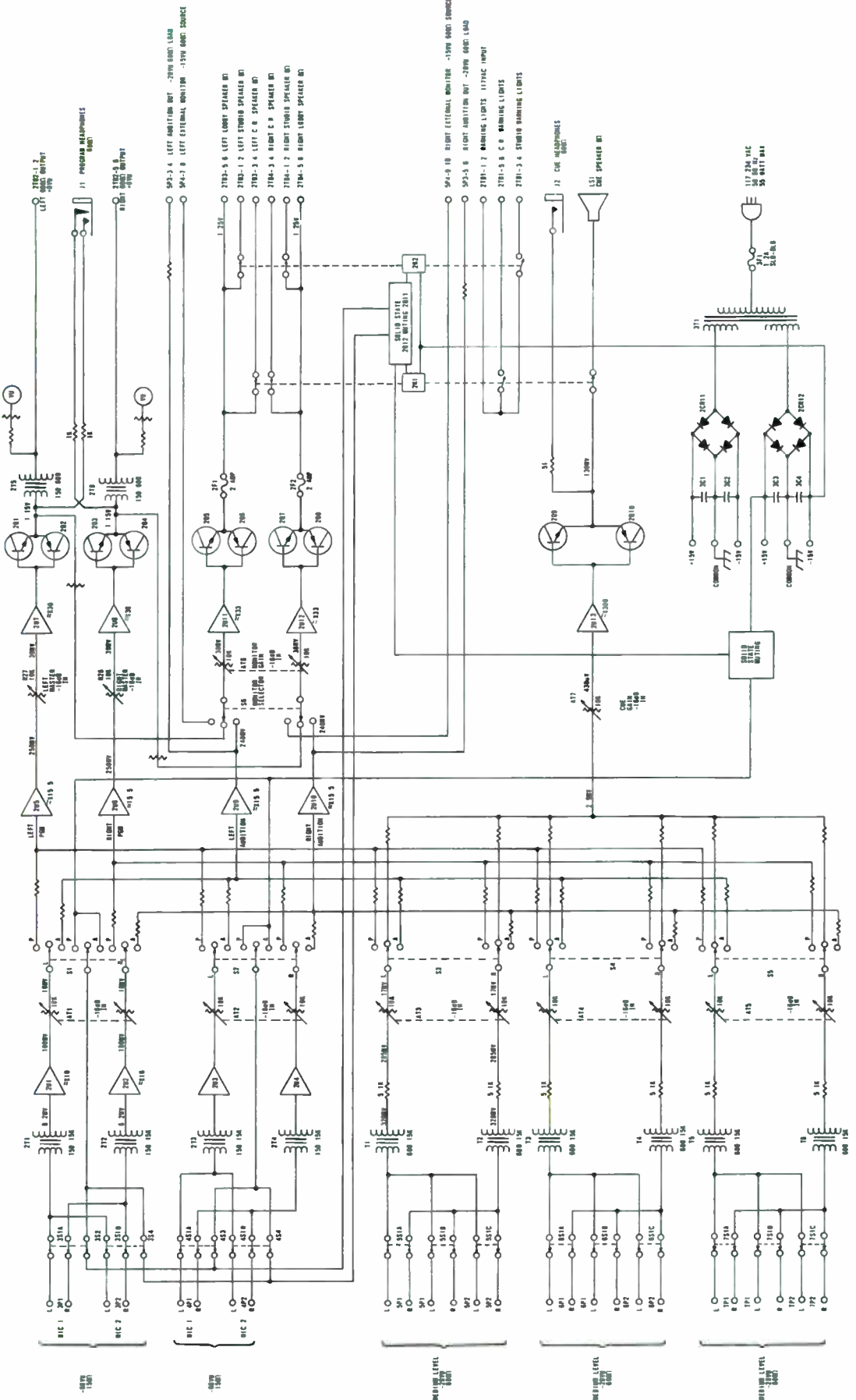

2. ONE SPEAKER USE WITH LEFT SIGNAL ONLY
 1. AC POWER SUPPLY SYSTEM USE 47.1, 0.001, 24
 00133

STEREO 5 FUNCTIONAL DIAGRAM

STEREO 5 SPECIFICATIONS

OPERATING MODE: Single-channel, stereophonic.

MIXING CHANNELS: Total-5. Two microphone channels, three medium level (turntable, tape, remote, network) channels. Cue positions on medium level channel switches.

INPUT CIRCUITS: Total-13. Four microphone inputs, nine medium level (turntable, tape, remote, network) inputs.

OUTPUT CIRCUITS: Total-5. Program, audition, two muted monitor for control room and studio, one unmuted monitor for lobby.

AMPLIFIERS AND POWER SUPPLY: Four pre-amplifiers, two program, one cue and two monitor amplifiers. Self-contained power supply.

IMPEDANCES: Microphones: 150/600 ohms, balanced. Medium level: 150/600 ohms, balanced. Program output: 150/600 ohms, balanced. Audition output: 1,400 ohms maximum. Monitor outputs: 8 ohms nominal. Audition and monitor outputs are unbalanced.

GAIN: Microphone input to line output: 100 dB, ± 3 dB. Medium level input to line

output: 60 dB, ± 3 dB. Medium level input to monitor output: 80 dB, ± 4 dB.

RESPONSE: Program circuits: ± 1 dB, 30-15,000 Hz. Monitor circuits: ± 1.5 dB, 30-15,000 Hz.

DISTORTION: Program circuits: 0.5% maximum @ ± 8 dBm; 1.0% maximum @ ± 18 dBm output level, 30-15,000 Hz. Monitor circuits: 3.0% maximum @ 6 watts output level (lobby output only).

NOISE: Program circuits: at least 70 dB below $+18$ dBm output with -50 dB input to mic channels or -10 dBm input to medium level channels. Monitor circuits: at least 70 dB below 6 watts output level with same input levels.

FINISH: Beige-gray Pebble-Tex cabinet, natural aluminum front panel.

POWER: 117/234 volts, $\pm 10\%$, 50/60 Hz, single phase, 55 watts maximum.

SIZE: 30 inches long, 8½ inches high, 17½ inches deep (76.2 cm x 21.6 cm x 44.5 cm).

WEIGHT: 44 pounds (20 kg).

SHIPPING DATA: Packed weight, domestic, 54 pounds; export, 104 pounds (47.2 kg).

ORDERING INFORMATION

Stereo 5, five-channel stereophonic audio console, complete with preamplifiers, program amplifiers, cue amplifier, monitor amplifiers, and self-contained power supply..... 994-7691-001



HARRIS

GATESWAY 80

8-Channel Solid-State Audio Control Console

- Eight monaural mixing channels
- Eighteen inputs to the mixers
- Extremely low distortion
- Interchangeable cue, monitor and program amplifiers
- All solid state plug-in amplifiers
- Excellent frequency response
- User serviceability

The Gateway 80 combines excellent audio, a wide choice of inputs, and operating ease in a unit which is attractively and functionally styled.

This is a high-quality monophonic console which provides all necessary studio functions and facilities for the typical AM, FM, or TV station that broadcasts monophonic programs exclusively.

INPUTS. The flexibility of the Gateway 80 is in its wide choice of inputs. Eighteen inputs can be switched into eight mixing channels. These include five microphones, four turntables, five tapes (cartridge or reel-to-reel), three remotes and network.

MIXING CHANNELS. Channels 1 and 2 are equipped with low-noise preamplifiers, and are to be used with low-impedance, broadcast-type microphones. Each of these channels may select from two different input signals by means of a front-panel switch.

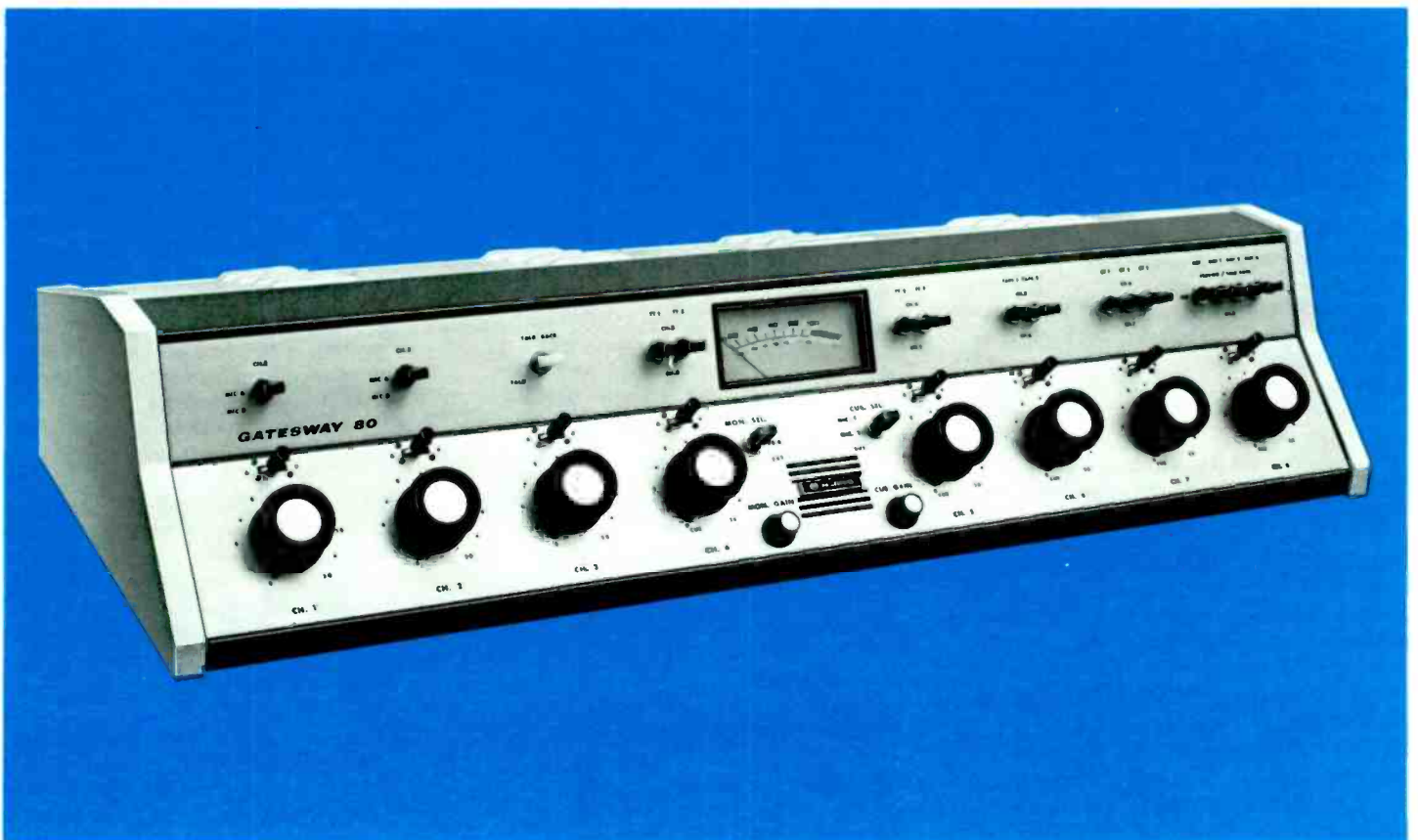

WIDE CHOICE OF INPUTS, UNSURPASSED SOUND

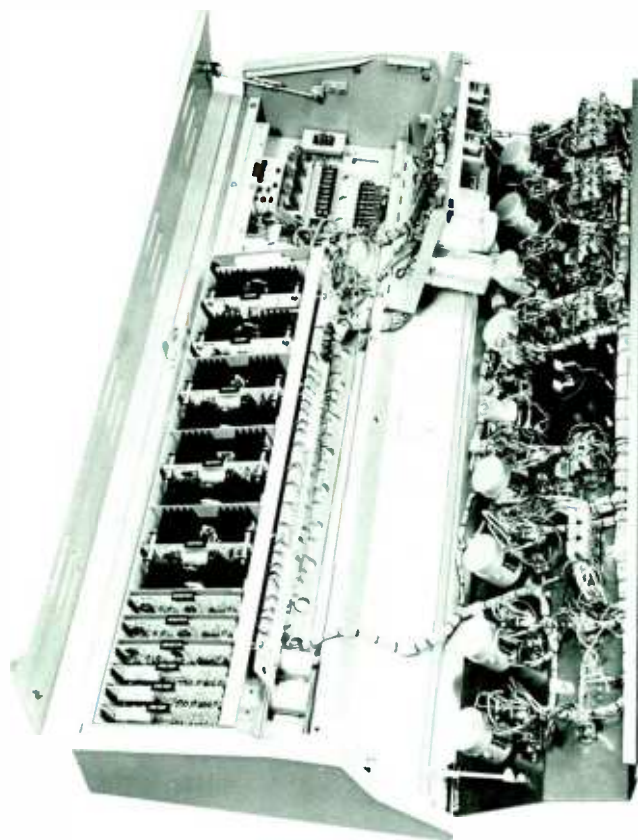

SERVICEABILITY

Full service accessibility to the Gateway 80 is through the hinged cabinet cover and panel. All plug-in modular components are easily removed for service.

Channel 3 is equipped with a low-noise preamplifier and is also intended for use with a low-impedance, broadcast-type microphone. This channel has a single input and is assigned to the control room since this microphone functions as part of the talkback system.

Channels 4, 5, 6 and 7 are all medium level inputs and may be used with turntable preamplifiers, reel-to-reel tape, or cartridge machines. All channels have input transformers whose center taps may or may not be grounded, depending upon the given installation. They are shipped with the center taps ungrounded. A nominal level of -20 dBm or $+4$ dBm at 600 ohms is required. Input pads for the $+4$ dBm are provided on the various tape inputs.

Channel 8 is specifically designed to function with network and remote lines as sources. Various combinations of preview, talkback, and program cue are possible using the front panel switches. A nominal input of at least -20 dBm at 600 ohms is required.

All eight channels may be switched to either the program or audition positions to permit independent monitoring of any of the incoming sources without disturbing

programming. Channels 4 through 8 have a cue position associated with the channel attenuator which provides signal to the amplified cue system. This signal can be monitored by an internal speaker or external headphones. On Channels 1 and 2, the center position of the program audition key switch provides a microphone cue signal to the cue selector switch. On Channel 3 this position is used with the control room microphone for talkback.

SPEAKER MUTING. A protective system of warning lights and relay speaker muting is provided to prevent acoustic feedback and broadcasting of cue signal when "live" microphones are nearby.

UNSURPASSED AUDIO. Harris advanced all solid state plug-in amplifiers are one of the many reasons for the excellence of the Gateway 80. Audio response is excellent, and distortion is at an extremely low level. The Gateway 80 provides first-class audio quality for AM, FM, TV broadcasting, and recording studios.

MODULAR CONSTRUCTION. Each amplifier is mounted on a separate printed circuit board, which in turn mounts in a card-rack holder. These modules are as follows: three preamplifier modules, three

booster amplifier modules, three output amplifier modules and two power supply regulator modules. High quality solid-state devices are used to assure the meeting of performance specifications and assure optimum console operation over a wide ambient temperature range. All amplifiers are completely accessible when the top of the console is opened, simplifying maintenance.

INTERCHANGEABILITY. Program, cueing, and monitor amplifiers all have the same electrical design and construction, and are completely interchangeable. As a result, two backup program amplifiers are provided as part of the console.

HIGH LEVEL, HIGH FIDELITY OUTPUT. The dynamic range of the preamplifiers will accommodate microphone levels to -17 dBm without overload or distortion. The program amplifiers deliver $+32$ dBm output and the monitor amplifiers $+40$ dBm, all with wide frequency response, low distortion and low noise.

STYLING. The Gateway 80 is handsomely styled with satin-anodized aluminum front panels, and neutral white cabinet with blue trim. The modern design will complement any control room decor.

GATESWAY 80 BLOCK DIAGRAM

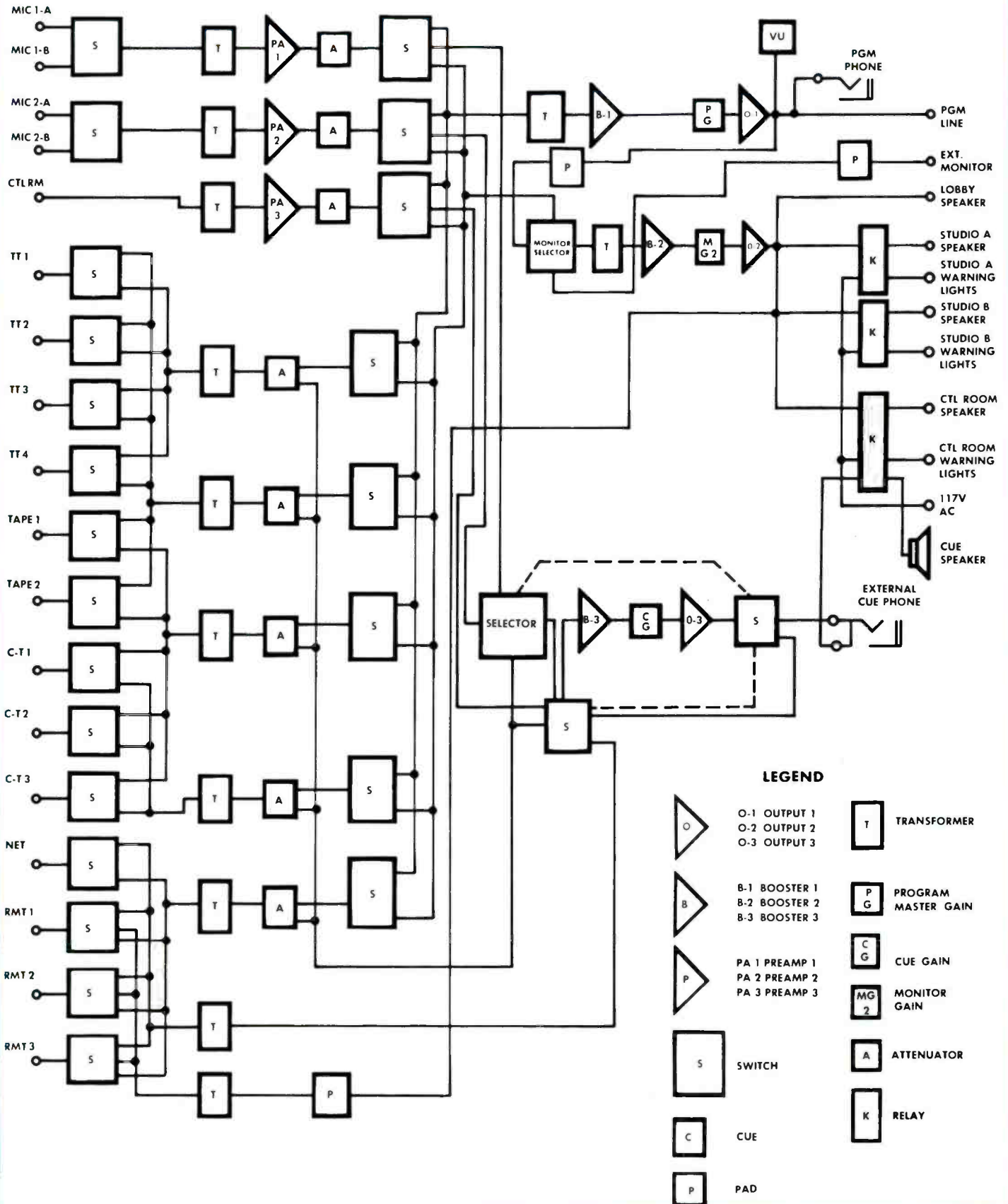

LEGEND

- | | | | |
|--|---|--|---------------------|
| | O-1 OUTPUT 1
O-2 OUTPUT 2
O-3 OUTPUT 3 | | TRANSFORMER |
| | B-1 BOOSTER 1
B-2 BOOSTER 2
B-3 BOOSTER 3 | | PROGRAM MASTER GAIN |
| | PA 1 PREAMP 1
PA 2 PREAMP 2
PA 3 PREAMP 3 | | CUE GAIN |
| | SWITCH | | MONITOR GAIN |
| | CUE | | ATTENUATOR |
| | PAD | | RELAY |



GATESWAY 80 SPECIFICATIONS

OPERATING MODE: Single channel mono with audition positions.

MIXING CHANNELS: Total—8. Three microphones, two turntables, two tapes and one remote/network.

INPUT CIRCUITS: Total—18. Five microphones, four turntables, two tape machines, three cartridge tape machines, three remote lines, one network.

AMPLIFIERS AND POWER SUPPLIES PROVIDED: Three preamplifiers, three boosters, three output modules—program, monitor and cue (interchangeable as supplied). Two power supply modules.

OUTPUT CIRCUITS: One program output @ +8 VU, one monitor speaker output unmuted for lobby, three monitor speakers muted, two headphone outputs.

MONITOR OUTPUT: +40 dBm @ 8 ohm minimum load. Multi-speaker operation should use high-impedance speakers (32-45 ohms) or accessory speaker matching transformer (48/8 ohms) for minimum load of 8 ohms.

GAIN: Microphone to line: 100 dB \pm 2dB. Medium level to line: 60 dB \pm 2 dB.

IMPEDANCES: Microphones: 150/250 ohms balanced. Turntable/tape: 600 ohms balanced. Network/remote: 600 ohms balanced. Monitor output: 8 ohms unbalanced.

RESPONSE: Program: \pm 1.0 dB, 20 Hz to 20 kHz.
Monitor: \pm 1.0 dB, 30 Hz to 15 kHz.

DISTORTION: Program circuits: 0.5% maximum, 20 Hz to 20 kHz @ +18 dBm.
Monitor circuits: 1.0% maximum, 30 Hz to 15 kHz @ +40 dBm (10 watts.)

NOISE: Program circuits: 75 dB below + 18 dBm with - 50 dBm input (-125 dBm equivalent input noise, measured 20 Hz to 20 kHz). Medium level inputs: (program) 80 dB below + 18 dBm with -10 dBm input. Monitor circuits: signal/noise = 80 dB below -40 dBm output.

FINISH: Satin-anodized aluminum panels with lettering in black. Cabinet color . . . neutral white, blue trim.

POWER: 117/234 volts, 50/60 Hz, single-phase. Consumption: 60 watts, maximum.

MECHANICAL SIZE: 39 inches wide, 15 $\frac{3}{4}$ inches deep, 7 $\frac{3}{4}$ inches high. Weight: 88 lbs.

SHIPPING DATA: Packed weight: domestic, 120 lbs.; export, 170 lbs. Cubage: 12.8 cubic feet (domestic).

SPECIFICATIONS SUBJECT TO CHANGE WITHOUT NOTICE

ORDERING INFORMATION

Gatesway 80, eight channel console, complete with three preamplifiers; three boosters; three program/monitor/cue output modules (interchangeable) and two power supplies 994-6699-001
Speaker Matching Transformer 478-0291-000



HARRIS

MONO 5

Solid-State 5-Channel Audio Control Console

- Thirteen inputs into five mixing channels
- Compact size saves control room space
- Quiet “push-on/push-off” input switches
- Extensive use of integrated circuits
- All solid state . . . silicon transistors
- Great versatility at a modest price

Harris' Mono 5 is a solid-state audio control console that provides a high degree of flexibility through the use of thirteen inputs into five monaural mixing channels. Although compact in size, and economical in price, the Mono 5 offers facilities and performance specifications comparable to many larger, more expensive consoles.





In medium and smaller size AM and monaural FM stations, the Mono 5 is ideal as a main console. In larger stations, the Mono 5 will find application as a production console, or may be used for independent programming from a second facility.

VERSATILE INPUT SWITCHING:

Thirteen inputs can be switched into the five mixing channels in a manner to satisfy most programming requirements. These inputs can include four microphones, three turntables, three cartridge reproducers, one reel-to-reel reproducer, one network and one auxiliary source. The thirteen front panel input switches are of the "push-on/push-off" type for quiet control room operation. There are isolation transformers on all program inputs and outputs.

MICROPHONE CHANNELS (1 & 2):

These two channels are equipped with low-noise preamplifiers for use with low-impedance, broadcast-type microphones. Each of the channels may select from two different input signals by use of front panel switches.

MEDIUM LEVEL CHANNELS (3, 4 & 5):

These three channels are designed for medium level inputs and may be used with turntables, cartridge tape machines, or reel-to-reel machines. Remote, network or auxiliary sources may be assigned to any of the nine medium level inputs.

PROGRAM, AUDITION AND CUE SELECTION:

Any of the five mixing channels may be switched to the Program Channel or Audition to permit independent monitoring or recording of incoming sources without disturbing programming. Channels 3, 4 and 5 also have cue positions, which provide signal to the amplified cue system. This signal can be monitored by an internal speaker or external headphones. Switching is by telephone-grade lever-type keys that provide maximum durability and reliability.

PROGRAM CHANNEL: The program channel consists of a summing type booster amplifier, audio output amplifier, VU meter, and a master gain control. The master gain control, an internal adjust-

ment, is preset at the factory to provide 16 dB of reserve gain for the console, and is the optimum setting for providing adequate operating margins of signal-to-noise and "headroom". The 4-inch VU meter is a standard volume indicator, and is used in conjunction with the mixing channel attenuators to establish a reference of "0" VU, which is equivalent to an output level of +8 dBm.

ADDITIONAL FACILITIES:

A three-position monitor selector switches the monitoring amplifier input to (1) program circuit, (2) terminals for an external source, and (3) audition circuit. Front panel controls also include monitor gain and cue gain, and conventional high impedance cue and program headset jacks are provided.

A protective system of warning lights and speaker muting is included in the Mono 5 to prevent acoustic feedback and broadcasting of a cue signal when live microphones are nearby.

MONO 5 SPECIFICATIONS

OPERATING MODE: Single channel, monophonic.

MIXING CHANNELS: Total-5. Two microphone channels, three medium level (turntable, tape, remote, network) channels. Cue positions on medium level channel switches.

INPUT CIRCUITS: Total-13. Four microphone inputs, nine medium level (turntable, tape, remote, network) inputs.

OUTPUT CIRCUITS: Total-5. Program, audition, two muted monitor for control room and studio, one unmuted monitor for lobby.

AMPLIFIERS AND POWER SUPPLY: Two pre-amplifiers, one program, one cue and one monitor amplifier. Self-contained power supply.

IMPEDANCES: Microphones: 150/600 ohms, balanced. Medium level: 150/600 ohms, balanced. Program output: 150/600 ohms, balanced. Audition output: 1,400 ohms. Monitor outputs: 8 ohms nominal. Audition and monitor outputs are unbalanced.

GAIN: Microphone input to line output: 100 dB, ± 3 dB. Medium level input to line output: 60 dB, ± 3 dB. Medium level input to monitor output: 80 dB, ± 4 dB.

RESPONSE: Program circuits: ± 1 dB, 30-15,000 Hz. Monitor circuits: ± 1.5 dB, 30-15,000 Hz.

DISTORTION: Program circuits: 0.5% maximum @ +8 dBm; 1.0% maximum @ +18 dBm output level, 30-15,000 Hz. Monitor circuits: 3.0% maximum @ 6 watts output level (lobby output only).

NOISE: Program circuits: at least 70 dB below +18 dBm output with -50 dB input to mic channels or -10 dBm input to medium level channels. Monitor circuits: at least 70 dB below 6 watts output level with same input levels.

POWER: 117/234 volts, $\pm 10\%$, 50/60 Hz, single phase, 37 watts maximum.

FINISH: Beige-gray Pebble-Tex cabinet, natural aluminum front panel.

SIZE: 30 inches long, 8½ inches high, 17½ inches deep (76.2 cm x 21.6 cm x 44.5 cm).

WEIGHT: 41 pounds (18.6 kg).

SHIPPING DATA: Packed weight, domestic, 51 pounds; export, 101 pounds (45.8 kg).

ORDERING INFORMATION

Mono 5, five-channel monaural audio console, complete with preamplifiers, program amplifier, cue amplifier, monitor amplifier, and self-contained power supply..... 994-7699-001



MSP-90 Audio Processor

- "Tailor" your sound to your format
- AM positive peak modulation adjustable 100% to 130%
- All in 3½ inches of rack space
- Extensive LED metering
- RFI protection...permits use in transmitter room
- Maximum processing flexibility

The Harris MSP-90 is an advanced audio processor that allows you to "tailor" your sound to your station's format. Reflecting today's latest design techniques, the MSP-90 offers unsurpassed audio performance plus convenient modular construction. And, due to the modern manufacturing techniques employed, including computerized testing, Harris is able to offer this audio processing series at surprisingly low prices.

Through its great flexibility, the Harris MSP-90 can be ordered in many configurations: as a mono or a stereo AGC amplifier; an AM limiter; a dual AM limiter; a mono or stereo FM limiter; an AGC amplifier/AM limiter; or an AGC amplifier/FM limiter. The main frame, which includes the power supply, is designed to accept any two of three plug-in modules (AM limiter, FM limiter, AGC amplifier) to provide the various configurations.

Performance specifications of the MSP-90 are excellent in all configurations. As the unit employs the most advanced circuitry available, it allows the highest possible modulation levels with minimum distortion.

The MSP-90 incorporates integrated circuit amplifiers with no discrete transistors. Audio transformers have been eliminated through the use of active instrumentation-type circuits, allowing the flexibility of balanced or unbalanced inputs, and eliminating distortion, ringing and the frequency and transient response problems normally associated with transformers.

Precision LED metering is provided on all modules for accurately measuring gain control and for indicating modulation percentage and output level. Dual regulation has been provided in the power supply for highest reliability. The supply is fully regulated to eliminate problems associated with high line voltages or brown-outs.

Special attention has been given to RFI protection through the use of shielding, filtering, grounding and special circuit design. The main frame utilizes extruded construction for extreme ruggedness, and the modular design allows easy servicing with the use of an optional extender card.



**MSP-90 Audio Processor,
AGC Amplifier/AM Limiter Configuration**



MSP-90 AM LIMITER MODULE

The MSP-90 AM limiter is designed for 125% positive peak modulation performance, allowing the loudest possible signal with minimum distortion. It eliminates the annoying "thumping", "pumping" and "clicks" associated with many low-priced limiters. Gain is controlled by a monolithic integrated circuit, and this modern fast limiter assures excellent noise and distortion specifications. Selectable recovery time is provided for "tailoring" the sound to station needs.

True asymmetrical limiting for 125% positive peak modulation is achieved through innovative circuit design. A polarity reversal circuit, employing digital detection techniques, reverses polarity only when the program waveform goes through a zero crossing. This allows very rapid, inaudible switching. Rapid recovery, with minimum low frequency distortion, is provided by a unique integrated circuit. This eliminates audio "holes" produced by most other techniques.

An input selector allows gain changes in 10 dB steps for up to a 30 dB increase in sensitivity, while a fine adjustment control allows an additional 10 dB range. An LED indicator is provided to show excessive drive into the first instrumentation amplifier. LED's are also provided on the front panel for readout of audio polarity and asymmetrical limiting.

Positive peak modulation is adjustable

from 100% to 130% to match your transmitter's capability.

AM LIMITER SPECIFICATIONS

INPUT: 600 ohms terminating. Maximum input level +25 dBm. 0 dB limiting threshold. +10 dBm to -30 dBm with switching level and input level control.

OUTPUT: 20 ohms for 600 ohm load. Nominal output level +10 dBm. Maximum output level +24 dBm.

GAIN: 20 dB \pm 1 dB with input amp set for 0 dB gain.

FREQUENCY RESPONSE: \pm 1 dB, 20 Hz to 20 kHz.

HARMONIC DISTORTION: (+10 dBm output) 0.15% maximum, 20 Hz to 20 kHz, limiter disabled; 1.0% maximum, 20 Hz to 20 kHz, 10 dB limiting, slow recovery.

INTERMODULATION DISTORTION: [60 Hz and 7 kHz mixed 4:1 at +10 dBm output (P. Eq)] 0.30% maximum, limiter disabled; 0.75% maximum, 10 dB limiting, single recovery.

NOISE: (20 Hz to 20 kHz) Signal-to-noise better than 70 dB below limiting threshold.

LIMITING RANGE: 15 dB.

LIMITING SLOPE: 18:1.

LIMITING ATTACK TIME: Less than 40 microseconds.

LIMITING RECOVERY TIME: Switch selectable from 1.3 seconds to 7.5 seconds. Single or dual time constant.

LIMITING CONTROL: On-Off.

ASYMMETRICAL CONTROL RANGE: 100% to 130%.

PAUSE CONTROL: + AUTO -

PAUSE DETECTOR LEVEL: -10 dB, -20 dB, -30 dB below limiting level.

PHASE SWITCHING TIME: Less than one microsecond.

PHASE ACTIVATION TIME: Minimum of 50 milliseconds, program dependent.

AC INPUT POWER: 117/234 volts \pm 10%, 50/60 Hz, 25 watts.

DC VOLTAGES: Dual series regulation at \pm 20 vdc and \pm 15 vdc.

TEMPERATURE RANGE: Operating: -20° to +55° C. Storage: -40° to +85° C.

HUMIDITY RANGE: Non-condensing, 5% to 90% relative.

ALTITUDE RANGE: To 10,000 feet A.M.S.L. (3048 meters).

DIMENSIONS: 16.6" (42.2 cm) W x 1.2" (3.0 cm) H x 10.3" (26.2 cm) D.

WEIGHT: 3 lbs. 2 oz. (1.42 kg).



MSP-90 FM LIMITER MODULE

The MSP-90 FM limiter is designed to prevent FM overmodulation while retaining maximum loudness with excellent clarity and fidelity. This is accomplished through a split spectrum limiting approach which prevents high frequency overdrive for pre-

emphasized systems such as FM, TV and SCA.

The gain controlling section is a fast limiter, which includes adjustable recovery time. It is designed to minimize noise and distortion.

After this precision high-speed limiter the signal is split into two audio bands, above and below 400 Hz. The high frequency band then feeds a parallel clamp circuit and another fast limiter, and LED's are used to indicate operation of the clamping

and limiting. Adjustable de-emphasis after the clamping sections minimizes audible harmonic distortion. As high frequencies affect overdrive greatly, they are controlled to a far more significant degree than the low frequency audio components, which have little overdrive potential.

The output signal may be adjusted to combine any ratio of limited or clamped high frequency signal with the unprocessed low frequency signal. After combining, a final broadband clamp circuit controls transient peaks and summation errors.

FM LIMITER SPECIFICATIONS

INPUT: 600 ohms terminating. Maximum input level +25 dBm. 0 dB limiting threshold, +10 dBm to -30 dBm with switching level and input level control.

OUTPUT: 600 ohms for 600 ohm load. Nominal output level +10 dBm. Maximum output level +18 dBm.

GAIN: 24 dB \pm 1 dB with input amp set for 0 dB gain.

FREQUENCY RESPONSE: \pm 1 dB, 20 Hz to 20 kHz.

HARMONIC DISTORTION: (+10 dBm output) 0.25% maximum, 20 Hz to 20 kHz, limiter disabled; 1.0% maximum, 20 Hz to 20 kHz, 10 dB limiting, slow recovery.

INTERMODULATION DISTORTION: [60 Hz and 7 kHz mixed 4:1 at +10 dBm output (P. Eq)] 0.25% maximum, limiter disabled.

NOISE: (20 Hz to 20 kHz) Signal-to-noise better than 70 dB below limiting threshold, FM in hard mode.

LIMITING RANGE: 15 dB.

LIMITING SLOPE: 30:1.

LIMITING START TIME: Less than 40 microseconds.

LIMITING RECOVERY TIME: Switch selectable from 1.3 seconds to 7.5 seconds. Single or dual time constant.

LIMITING CONTROL: On-Off.

FM PROTECTION: Split band - dual mode.

PRE-EMPHASIS: 0, 25, 50, 75 microseconds.

DE-EMPHASIS: 0, 25, 50, 75 microseconds.

AC INPUT POWER: 117/234 volts \pm 10%, 50/60 Hz, 25 watts.

DC VOLTAGES: Dual series regulation at \pm 20 vdc and \pm 15 vdc.

TEMPERATURE RANGE: Operating: -20° to +55° C. Storage: -40° to +85° C.

HUMIDITY RANGE: Non-condensing, 5% to 90% relative.

ALTITUDE RANGE: To 10,000 feet A.M.S.L. (3048 meters).

DIMENSIONS: 16.6" (42.2 cm) W x 1.2" (3.0 cm) H x 10.3" (26.2 cm) D.

WEIGHT: 3 lbs. 2 oz. (1.42 kg).



MSP-90 AGC AMPLIFIER MODULE

The Harris MSP-90 AGC amplifier is the most versatile automatic gain control unit available today, with a wide range of controls to ensure maximum processing flexibility. It is designed to ideally complement the MSP-90 AM or FM limiters.

The gain controlling section provides up to 12 dB of expansion and 24 dB of compression. Adjustments include: separate attack and recovery times for the expander and the compressor; a threshold control for expansion; a selector switch for adjusting the expansion level in 3 dB increments; and a four-position slope control. An advanced integrated circuit used for gain control minimizes noise and distortion, and provides exact tracking between left and right channels when used for stereo.

An input sensitivity switch allows gain changes in 10 dB steps up to a 30 dB increase in sensitivity, while a fine adjustment control provides an additional 10 dB range.

An overdrive indicator is provided to show excessive drive to the input amplifier, and LED indicators are provided for both gain control and output level. The gain controlling LED's show both expansion and compression operation, while separate LED's show actual output level.

AGC AMPLIFIER SPECIFICATIONS

INPUT: 600 ohms terminating. Maximum

input level +30 dBm. Compression threshold +6 dBm to -26 dBm with switching level and input level control.

OUTPUT: 600 ohms for 600 ohm load. Nominal output level +10 dBm. Maximum output level +18 dBm.

GAIN: 31 dB \pm 1 dB with input amp set for 0 dB gain, expansion and compression functions disabled.

FREQUENCY RESPONSE: \pm 1 dB, 20 Hz to 20 kHz.

HARMONIC DISTORTION: (+10 dBm output) 0.25% maximum, 20 Hz to 20 kHz, AGC disabled; 1.0% maximum, 20 Hz to 20 kHz, AGC on, SLOW.

(Continued on back page)

AGC Amplifier Module (continued)

INTERMODULATION DISTORTION: [60 Hz and 7 kHz mixed 4:1 at +10 dBm output (P. Eq)] 0.25% maximum, AGC disabled; 1.5% maximum, AGC on, SLOW.

NOISE: (20 Hz to 20 kHz) Signal-to-noise better than 75 dB below compression threshold.

EXPANSION RANGE: Selectable at 3 dB, 6 dB, 9 dB or 12 dB.

EXPANSION SLOPE: Approximately 2.5:1.

EXPANSION ATTACK TIME: Selectable at 1 second, 500, 300, 200 or 100 milliseconds.

EXPANSION RECOVERY TIME: Selectable at 15, 5, 2.5 or 1 second(s).

EXPANSION THRESHOLD: ± 5 dB.

COMPRESSION RANGE: 24 dB.

COMPRESSION SLOPE: Selectable at 24:1, 12:1, 6:1 or 3:1.

COMPRESSION ATTACK TIME: Selectable at 32, 24, 15, 11, 9, 7, 5, 3 and 1 milliseconds.

COMPRESSION RECOVERY TIME: Selectable at 16, 8, 4, 3, 2, 1, 0.5 sec triple time constant.

AC INPUT POWER: 117/234 volts $\pm 10\%$, 50/60 Hz, 25 watts.

DC VOLTAGES: Dual series regulation at ± 20 vdc and ± 15 vdc.

TEMPERATURE RANGE: Operating: -20° to $+55^\circ$ C. Storage: -40° to $+85^\circ$ C.

HUMIDITY RANGE: Non-condensing, 5% to 90% relative.

ALTITUDE RANGE: To 10,000 feet A.M.S.L. (3048 meters).

DIMENSIONS: 16.6" (42.2 cm) W x 1.2" (3.0 cm) H x 10.3" (26.2 cm) D.

WEIGHT: 3 lbs. 2 oz. (1.42 kg).

MSP-90 MAIN FRAME

Only 3½ inches of vertical 19-inch rack space is required to mount the MSP-90 main frame, which supplies input/output connections and regulated DC power for two MSP-90 modules. Heavy duty construction is used throughout for ruggedness and durability. The conserv-

atively-rated, well-regulated primary power supply will operate on 115V or 230V, while protecting the modules from brownouts and severe overvoltage surges. Well-ventilated aluminum top and bottom covers keep modules cool and dust free. Nylon guide rails and gold-plated sockets

insure excellent mechanical and electrical connections for all modules. Dimensions: 19.0" (48.3 cm) W x 3.5" (8.9 cm) H x 15.5" (39.4 cm) D. Weight: 12 lbs. 13 oz. (5.81 kg).

MSP-90 ORDERING INFORMATION

The MSP-90 may be ordered in the configurations listed below. Optional modules are listed as spares or to allow you to reconfigure a unit. For instance, you could order an FM limiter module,

and use it to turn an MSP-90 mono FM limiter into a stereo unit if your station goes stereo at a later date.

MSP-90 AM Limiter	994-8200-001
MSP-90 FM Limiter (Monaural)	994-8201-001
MSP-90 FM Limiter (Stereo)	994-8202-001
MSP-90 AGC Amplifier (Monaural)	994-8203-001
MSP-90 AGC Amplifier (Stereo)	994-8204-001
MSP-90 AGC Amplifier/AM Limiter	994-8205-001
MSP-90 AGC Amplifier/FM Limiter	994-8206-001

NOTE: An extender card is included with each of the above.

MSP-90 OPTIONAL SPARE MODULES

AM Limiter Module	992-5235-002
FM Limiter Module	992-5236-002
AGC Amplifier Module	992-5237-002

SPECIFICATIONS SUBJECT TO CHANGE WITHOUT NOTICE.



MSP-90 TRI BAND AGC Audio Processor

- **MSP-90 Tri Band AGC: A true automatic gain amplifier, not just a compressor**
- **Time averaged true RMS power control**
- **Phase coherent filtering with adjustable band to band crossover frequencies**
- **Program dependent attack time**
- **Front panel output mix controls enable equalization of audio chain for optimum results**
- **Ease of setup and operation**

With the development of the MSP-90 Tri Band AGC, Harris furthers the technical advancement of audio processing and offers the broadcaster an added opportunity to increase his coverage area through a louder signal and improved modulation.

Characterized by outstanding reliability, total flexibility, modular construction, and state-of-the-art circuitry, the Tri Band AGC boasts a performance level previously unattainable in a stand alone unit. In addition, the Tri Band AGC provides high quality and low distortion while maintaining the Harris reputation for cost sensitivity.

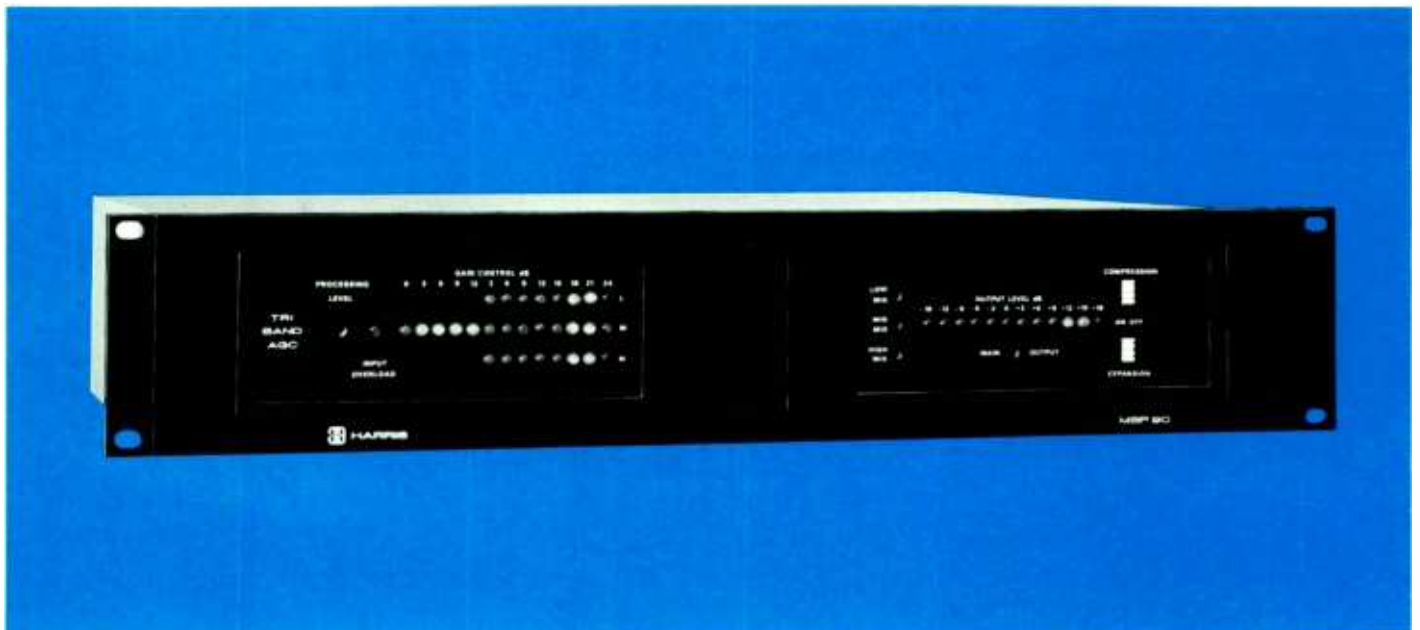

With a performance level far beyond old gated compressor type models, the Tri Band AGC is a true Automatic Gain Control amplifier system based upon complementary expansion and compression which totally eliminate irritating noise swish-up.

The time averaged RMS power control significantly increases signal power without affecting peak levels. Unlike less advanced RMS processors that rely on the use of non-linear LED-PHOTO-CELL combinations, advanced circuitry in the MSP-90 Tri Band AGC amplifier actually CALCULATES the RMS signal power, making it possible to maintain the timbre of musical signals while simultaneously increasing loudness.

Crossover anomalies and dead spots in frequency response, which are common in less sophisticated equipment, have been eliminated in the MSP-90 Tri Band AGC through the use of phase coherent, single pole, band to band filtering with adjustable turnover frequencies. Because the turnover frequencies of the Tri Band AGC are each adjustable over three octaves, the Harris AGC module has become the answer to the broadcasters' needs today and in the future.

Program dependent attack time assures minimum distortion at low frequencies and optimizes crisp, clear highs. The Tri Band processing plus RMS control eliminate the problems normally associated with record pops and clicks, thus guaranteeing the most trans-

parent operation possible.

The front panel output mix controls of the MSP-90 Tri Band AGC provide the broadcaster with the capability of altering the frequency response of the audio chain without the use of external equalizers. Adequate equalization for all formats and transmitting media is assured by the ± 10 dB control range of each band.

The Tri Band AGC amplifier module plugs easily into the rugged MSP-90 main frame to offer today's creative broadcaster unsurpassed audio performance coupled with flexibility and convenience. The conservatively rated, well-regulated primary power supply will operate on 115V or 230V, while protecting the amplifier module from brownouts and severe overvoltage surges.

MSP-90 TRI BAND AGC SPECIFICATIONS

INPUT: 600 ohm terminating. Maximum level +28 dBm. Compression threshold +4 dBm to -26 dBm.

OUTPUT: 600 ohm for 600 ohm load. Nominal output level +10 dBm. Maximum output level +18 dBm.

FREQUENCY RESPONSE: ± 1 dB, 20 Hz to 20 kHz, controls flat.

HARMONIC DISTORTION: (+10 dBm output) 0.25% maximum, 20 Hz to 20 kHz disabled; 0.5% maximum, 20 Hz to 20 kHz, enabled, slow.

INTERMODULATION DISTORTION: (+10 dBm output) 0.25% maximum disabled; 0.5% maximum, enabled, slow; SMPTE.

NOISE: (20 Hz to 20 kHz) Signal-to-noise better than 70 dB below compression threshold.

EXPANSION RANGE: Selectable at 3 dB, 6 dB, 9 dB or 12 dB.

EXPANSION SLOPE: 2:1.

EXPANSION THRESHOLD: ± 5 dB from normal -20 dBm.

EXPANSION ATTACK TIME: 0.1, 0.2, 0.3, 0.5 or 1 second.

EXPANSION RECOVERY TIME: 0.25, 0.5, 1, 2, 4, 8 or 16 second(s).

COMPRESSION RANGE: 24 dB.

COMPRESSION SLOPE: Selectable at 24:1, 12:1, 6:1 or 3:1.

COMPRESSION TYPE: True RMS power control.

COMPRESSION ATTACK TIME: Program dependent, 2.5 m Sec. to 250 m Sec.

COMPRESSION RECOVERY TIME: 0.25, 0.5, 1, 2, 4, 8 or 16 second(s).

OUTPUT MIX: Each band can be varied ± 10 dB from nominally flat.

BAND SPLITTING: Phase linear, selectable; low frequency crossover 75, 95, 105, 135, 160, 230 or 320 Hz; high frequency crossover 1680, 2180, 2450, 3060, 3700, 5300 or 7200 Hz.

SPECIFICATIONS SUBJECT TO CHANGE WITHOUT NOTICE.

ORDERING INFORMATION

MSP-90 TRI BAND AGC with main frame (monaural) 994-8357-001
 MSP-90 TRI BAND AGC with main frames (stereo) 994-8358-001



HARRIS

MSP-95 FM AUDIO CPU

(Composite Processing Unit)

- Local/Remote Stereo Generator
- Drives composite STL or wideband FM exciter input
- Digitally Synthesized Modulation
- Dynamic Transient Response
- Low output impedance
- Remotely selectable operational mode
- Active transformerless inputs
- Selectable pre-emphasis
- Split-band dual-function FM protection
- Unique "soft syncing" recovery system
- Extensive LED metering
- RFI protected
- Modular construction

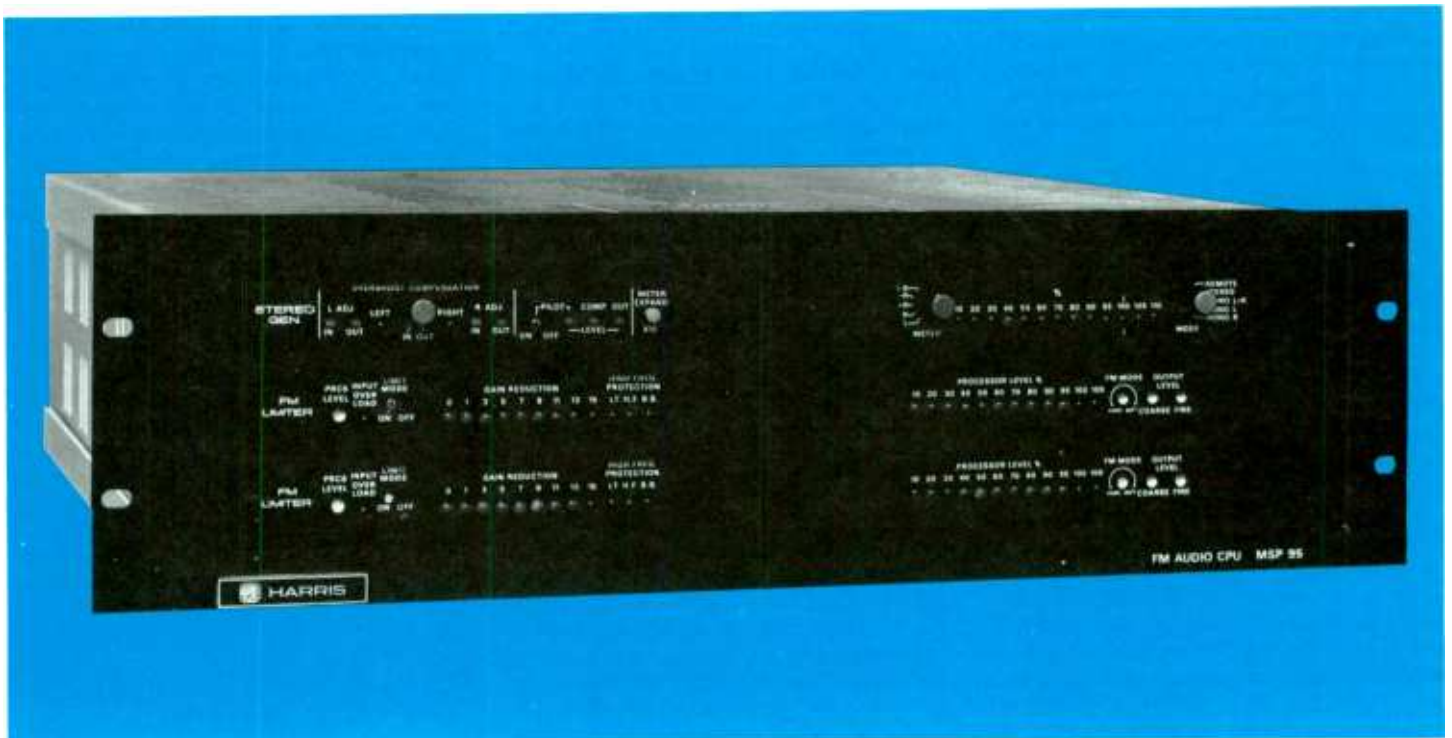

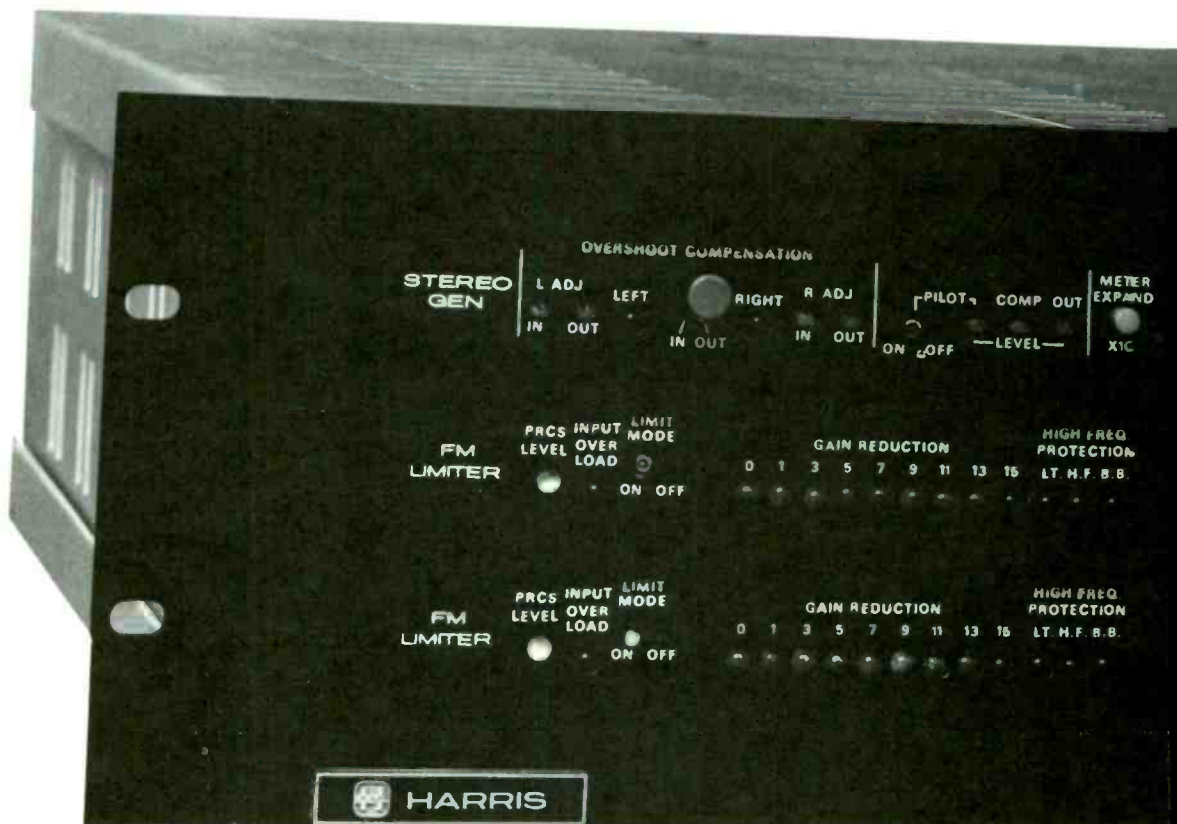

The MSP-95 FM Audio Composite Processing Unit features an integrated designed Stereo Limiter/Generator, specifically suited for FM stations using an STL link. It drives composite Studio/Transmitter Links or wideband input of any FM exciter. The carefully engineered MSP-95 is a precision modular product that delivers studio program fidelity to remote FM transmitters and matches high performance studio equipment to an STL link. The MSP-95 FM Audio CPU is an exclusive Harris development, featuring Digitally Synthesized Modulation (DSM) and patented Dynamic Transient Response (DTR). The DTR filter, developed by Harris for FM stereo, holds overshoot on any program material to 2% or less. Mono mode switching allows front panel or remote selection of L+R, L, or R. A unique recovery system, "Soft Syncing", maintains stereo imagery while increasing loudness. Additional features of the MSP-95 include low output impedance for driving various lengths of coaxial cable; extensive LED metering; wide use of multiturn pots; and socketed ICs for easy troubleshooting and serviceability.

MAINFRAME

The MSP-95 mainframe is a compact assembly designed to fit in a standard 19-inch rack, and occupies just 5¼ inches of vertical rack space. Double Power Supply regulation is incorporated to assure brownout protection. For further reliability, all connections are easily made via terminal strips or

BNC connectors. The MSP-95 rear panel offers quick access to power supply, line fuses, input and output connections, and I/O board. Audio inputs are filtered for RFI protection. Card guides are utilized for precise alignment of modules to the motherboard, and highly reliable ribbon cable is used on internal connections.

FM LIMITER

Harris' superb FM limiter gives the MSP-95 FM Audio CPU true instrumentation amplifier input for low distortion. The limiter also delivers excellent transient response and high common mode rejection. The input amplifier includes switch selectable gain over a 40 dB range, and a 600 ohm input impedance which can be easily changed. An input overload indicator is provided. Four quadrant multipliers are used for all limiting functions for low THD and IMD. Harris' split dual function processing provides the utmost in user flexibility. Tailoring the limiter to individual station formats is a simple exercise. Adjustments of recovery time, high frequency protection threshold, high frequency limiting or clipping can be accomplished in minutes. Switch selectable precision pre-emphasis gives access to 25, 50 and 75 microseconds curves. Dual recovery limiting allows the limiter to rapidly recover on short musical bursts while maintaining a slower recovery time on the majority of program audio. The resulting sound is less self modulated by peaks and more dynamic. Harris' high performance LED metering dis-

plays monitor all major functions of the MSP-95 limiter, including broadband gain reduction, high frequency protection and output. The broadband and high frequency limiters are strapped to eliminate image shifting.

STEREO GENERATOR

Unlike earlier types of stereo generators, the MSP-95 does not suffer from lower separation at the frequency extremes, thanks to Digitally Synthesized Modulation (DSM). Minimum separation is 45 dB from 30 to 15,000 Hz, typically exceeding 50 dB. This generator provides a clean baseband signal which promotes minimal interaction between stereo and SCA operation. What's more, the high performance characteristics of the DSM generator are easily maintained year after year. All digital signals, including the pilot, are generated from a crystal controlled master clock. An automatic pilot phase control makes misadjustment virtually impossible. Overshoot compensation is accomplished by a Harris patented Dynamic Transient Response (DTR) filter. Overshoot on any program material is held to 2% or less with no degradation in audio quality. As a result, a 2 to 6 dB increase in loudness can be achieved from the stereo generator alone. Controlled transient response, high stereo separation, low crosstalk and low intermodulation distortion are maintained with the increased loudness. Fast LED metering replaces analog meters.

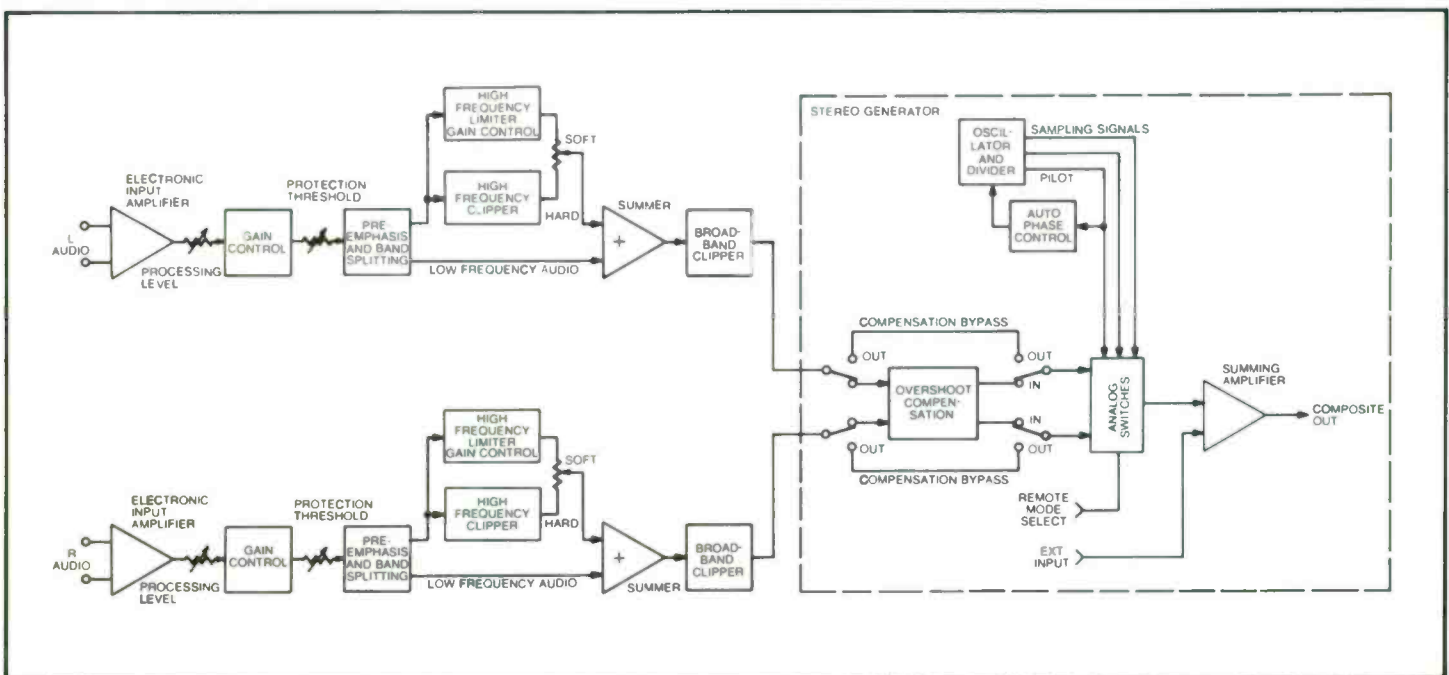
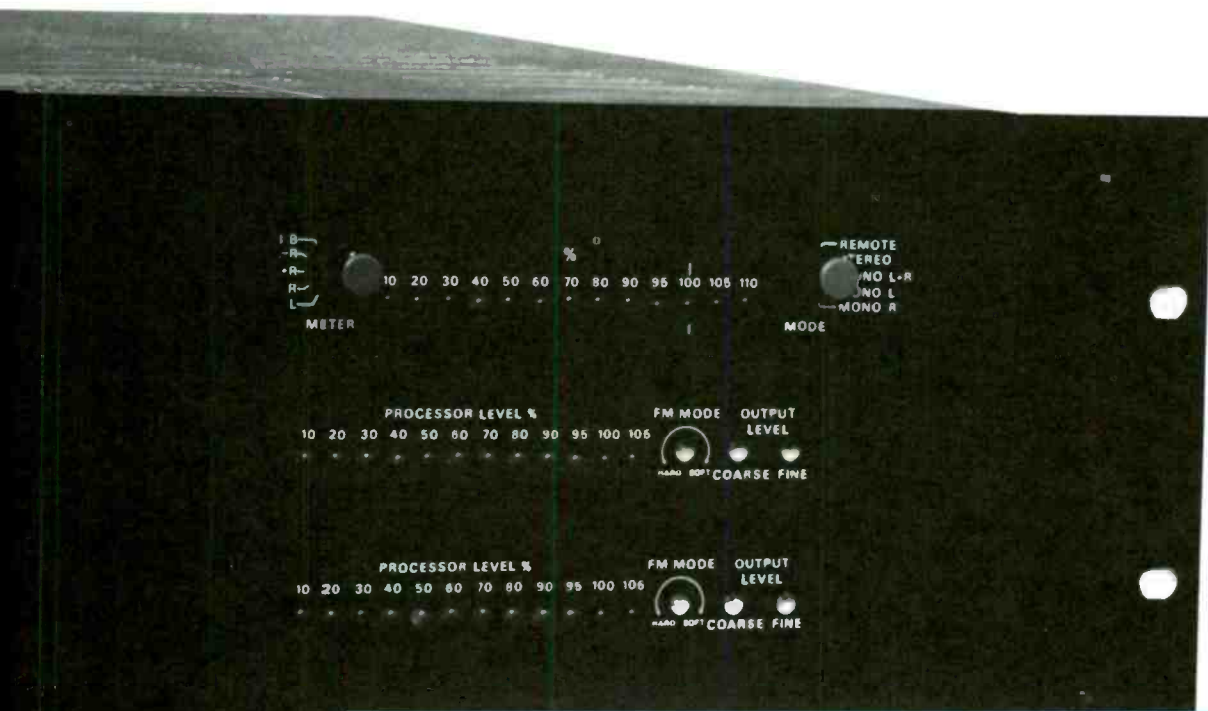

MSP-95 SPECIFICATIONS

AC INPUT POWER:

117/234 volts, $\pm 10\%$, 50/60 Hz, 50 watts

DC VOLTAGES:

dual series regulation at ± 20 VDC and ± 15 VDC, ± 6 VDC

HUMIDITY RANGE:

non-condensing to 90% relative

ALTITUDE:

to 10,000 feet A.M.S.L. (3048 meters)

TEMPERATURE RANGE:

0°C to +50°C. Storage -40°C to +85°C.

DIMENSIONS:

19" W x 5.25" H x 15.5" D (48.3 cm W x 13.3 cm H x 39.4 cm D)

WEIGHT:

24 pounds (10.9 kg)

CONNECTIONS:

barrier strips and BNC jacks

INPUT:

600 ohms terminating. Adaptable to other impedances. Input Level: 0 \pm 1 dBm for 100% modulation. Switch selectable for +10 dBm, -10 dBm, -20 dBm, or -30 dBm.

EXTERNAL INPUT FOR SCA:

10K resistive, unbalanced. Amplitude response ± 0.25 dB, 30-75,000 Hz.

OUTPUT:

150 ohms unbalanced, resistive (BNC connector). Adjustable from less than 1V RMS to greater than 4.5V RMS for 100% modulation

AUDIO FREQUENCY RESPONSE:

(Left and Right) standard 75 microsecond FCC pre-emphasis curve ± 0.5

dB, 30-15,000 Hz; selectable; flat; 25; or 50 microsecond pre-emphasis

TYPE OF MODULATION:

Digitally Synthesized Modulation (DSM)

INPUT FILTERING:

15 kHz LPF, 50 dB minimum rejection at 19 kHz and above

OVERSHOOT PROTECTION:

Dynamic Transient Response (DTR) filter

AUDIO TRANSIENT RESPONSE:

2% maximum overshoot beyond steady state

HARMONIC DISTORTION:

1V RMS output, 0.25% maximum, 30-15,000 Hz, limiter disabled; 1% maximum, 30-15,000 Hz, 10 dB limiting. Slow recovery. THD of stereo generator typically less than 0.1%

INTERMODULATION DISTORTION:

SMPTE 4:1 at 1V RMS output (P.EQ) 0.25% maximum, limiter disabled. Stereo generator typically less than 0.1% IMD

NOISE:

Left or right 70 dB minimum below 100% modulation. Reference: (400 Hz, 75 microsecond de-emphasis, 1V RMS output, measured 30-15,000 Hz.

CROSSTALK:

(main to stereo sub-channel or stereo sub-to-main channel; test mode) greater than 40 dB below 90% modulation. Typically greater than 40 dB with limiters enabled

PILOT OSCILLATOR:

crystal controlled

PILOT STABILITY:

19 kHz ± 1 Hz, 0°C to 50°C

PILOT PHASE:

automatically controlled

STEREO SEPARATION:

45 dB minimum, 30-15,000 Hz

DYNAMIC STEREO SEPARATION:

40 dB minimum under normal programming

SUBCARRIER SUPPRESSION:

60 dB minimum below 100% modulation

76 kHz SUPPRESSION:

60 dB minimum below 100% modulation

MODES:

stereo (L+R), mono (L), mono (R), remote

LIMITING RANGE:

15 dB

LIMITING SLOPE:

30:1

LIMITING ATTACK TIME:

less than 40 microseconds

LIMITING RECOVERY TIME:

switch selectable from 1.3 seconds to 7.5 seconds

FM PROTECTION:

split band - dual mode

SPECIFICATIONS SUBJECT TO CHANGE WITHOUT NOTICE

ORDERING INFORMATION

MSP-95 FM Audio Composite Processing Unit994-8441-001



HARRIS

MSG-95 Remote SCA Generator

- **Isolated AC coupled input provides line isolation and common mode rejection**
- **DC coupled input for superb slow scan video applications**
- **Built-in low pass filter with selectable cut-off**
- **Selectable pre-emphasis**
- **Selectable or automatic muting minimizes objectionable receiver noise**
- **Front panel LED indicators supply quick operational status**

Recognizing the increasing flexibility and demands of SCA service, Harris has developed the MSG-95 remote SCA generator to meet the most demanding requirements. The MSG-95 is designed for use with most exciters or STL links, and is an ideal companion unit to the Harris MSP-95 FM audio composite processing unit.

INPUTS. The MSG-95 is equipped with two input terminals. One is an AC coupled input for general SCA programming needs. The other is a DC coupled input which handles the demands of SCA broadcasters programming slow scan television data.

AUDIO FILTERING. Since SCA programming needs vary considerably, Harris has included a standard low pass filter in the MSG-95. The programmable low pass filter provides the necessary bandwidth protection for stations operating one or two SCA's or stereo programming.

SELECTABLE PRE-EMPHASIS AND MUTING. Again providing the station operator with maximum flexibility to meet operating criteria, the MSG-95 incorporates selectable pre-emphasis of 150, 75, 50 microsecond or flat response. Lengthy bursts of noise in background music or other SCA applications, such as quotation services, can be distracting. To address the wide ranging muting requirements, the MSG-95 muting delay can be adjusted anywhere from ½ second to 20 seconds. It is triggered by a drop in audio level, the threshold of which is adjustable from 0 to -30 dBm.

OPERATIONAL CONTROLS/STATUS DISPLAY. At a glance, station personnel can quickly determine the operating mode of the MSG-95 SCA generator. Color-keyed status indicators are positioned adjacent to the "On", "Automatic", and "Off" pushbutton selector switches. Technicians will find the front panel injection level and subcarrier adjust potentiometers convenient. Troubleshooting is also aided by the front panel power supply status LED.

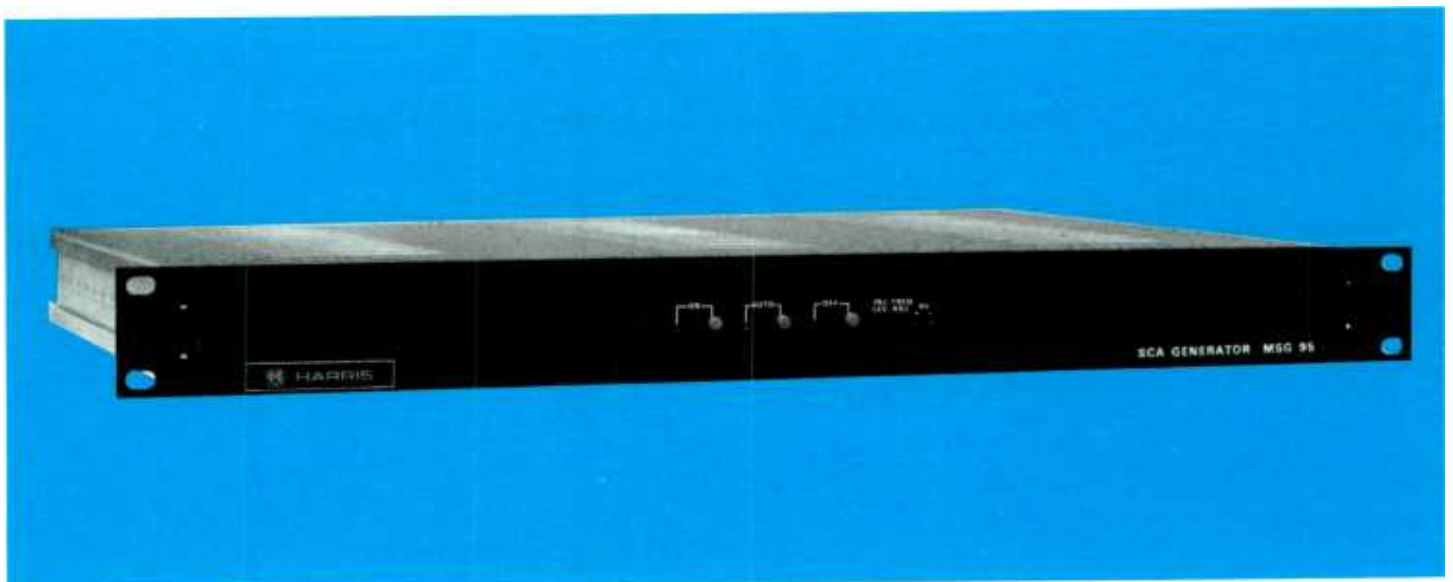

MSG-95 SPECIFICATIONS

FREQUENCY RANGE:	41 kHz or 67 kHz
FREQUENCY STABILITY:	± 500 Hz ($\pm 0.7\%$)
TYPE OF MODULATION:	DCFM
HARMONIC CONTENT OF SUBCARRIER:	less than 1%
FM NOISE:	-55 dB for 5 kHz deviation
MODULATION RESPONSE:	± 1 dB, 150 usec pre-emphasis (30 Hz to 4 kHz)
MODULATION DISTORTION:	less than 1% (measured at 200 Hz and 3.5 kHz)
MODULATION CAPABILITY:	± 5 kHz
PRE-EMPHASIS:	150, 75, 50 usec or flat
SUBCARRIER STATUS:	LED indicators
PROGRAM INPUT IMPEDANCE:	will accept 600 ohm or 150 ohm source
AUDIO INPUT LOW PASS FILTER:	4.5 kHz standard; 3 kHz, 5 kHz, 7.5 kHz selectable
PROGRAM INPUT LEVEL:	+2 dBm; ± 1 dB for 100% modulation
TELEMETRY INPUT CONNECTOR:	BNC female
TELEMETRY INPUT LEVEL:	1 volt for 5 kHz carrier deviation
SUBCARRIER OUTPUT IMPEDANCE:	less than 1000 ohms
SUBCARRIER OUTPUT LEVEL:	100 mV across 10k ohms (adjustable to 300 mV)
MUTING DELAY:	0.5 Sec. to 20 Sec., adjustable
SUBCARRIER OUTPUT CONNECTOR:	BNC female
OPERATING TEMPERATURE RANGE:	-20°C to +45°C
POWER REQUIREMENTS:	105-129 VAC, 50/60 Hz
SIZE:	1 $\frac{3}{4}$ " H \times 19" W \times 16" D
WEIGHT:	6 pounds

SPECIFICATIONS SUBJECT TO CHANGE WITHOUT NOTICE

ORDERING INFORMATION

MSG-95 stand-alone SCA Generator994-8492-001



HARRIS

CB-1201 Precision Professional Turntable

- Stereo rumble better than -45 dB
- Rugged precision construction...only 3 rotating parts
- Full speed in less than 1/16 revolution
- Front panel controls
- Three speeds
- No 45 RPM spindle required
- Speed may be changed with turntable operating
- Unique Teflon® coated sleeve on speed change lever



The Harris CB-1201 offers the ultimate in engineering excellence, and a high standard of accuracy in disc reproduction for on-air use and production work. In addition, operation and maintenance are simplified, as there are only three rotating parts in the unit.

The CB-1201 professional transcription turntable chassis provides both short and long term speed accuracy over a wide temperature and voltage range through the use of an extremely well balanced hysteresis synchronous motor and a low-friction dual oilite center bearing. The rugged motor, the simplified motor mounting, and an advanced shift mechanism all combine to provide top reliability, even with 24-hour-a-day use.

RUMBLE BETTER THAN -45 DB. Exceptionally low rumble has been achieved in the CB-1201 through precision engineering of the drive system. The motor is precision balanced with a ground steel three-step driving surface held to an accuracy of $\pm 0.0003''$. The idler wheel has an exclusive "shear action" to allow maximum drive torque with minimum vibration. The bearing of the idler is oil-impregnated sintered bronze rotating on a 10 micro-inch polished steel shaft held to an accuracy of $\pm 0.00015''$, further reducing rumble and wow and flutter.

The well-balanced platter rotates on a dual sintered, impregnated bronze bearing made with the same high precision as the idler rotating surfaces.

Measured below NAB reference of 1 kHz recorded at 3.54 cm/sec rms velocity, stereo rumble in the CB-1201 is better than -45 dB at 33 $\frac{1}{3}$ rpm, which compares with the best in the industry.

WOW & FLUTTER LESS THAN 0.1% (NAB unweighted). The heavy (6.9 lb.) machined aluminum platter in the CB-1201 provides for optimum flywheel action to help reduce wow and flutter while permitting very tight cueing. The virtually friction-free drive components further reduce the speed variations that also contribute to wow and flutter.

An exclusive innovation, the Teflon-sleeved speed change lever, allows frictionless "breathing" of the idler mechanism, and accounts for the exceptional sound reproduction quality.

SPEED ACCURACY BETTER THAN $\pm 0.3\%$. Because of the sophisticated bearing and drive surfaces, long term speed variations are reduced to a negligible level for the life of the turntable. Short term speed variation, sometimes misinterpreted as wow and flutter, is in the order of 0.001%.

RUGGED, DURABLE CONSTRUCTION. The rugged main frame is constructed of a one-piece machined casting of aluminum alloy. It is attractively styled in off-white, with front die-cast panel and heavy felt platter cover in contrasting blues.

The platter is recessed into the base for maximum protection, and is offset from the center of the base to allow plenty of clearance for arm swing. The platter is also specially designed to play 45's with no accessory spindle.

Specifications, ordering information, accessories on reverse side.

CB-1201 SPECIFICATIONS

TURNTABLE PLATTER: Cast aluminum; diameter, 12"; weight, 6.9 lbs.
CHASSIS SIZE: 16"x16"x2¼". Motor hangs 5½" below bottom of chassis.
FINISH: Base in off-white, with blue front panel. Platter cover in blue heavy felt.
CENTER BEARING: ¾" diameter dual oilite bearings.
MOTOR: Hysteresis synchronous, single phase, 1800 rpm. 117V 60 Hz, 117V 50 Hz, 220V 50 Hz.
CUEING: With dead motor start: at 33⅓ rpm, less than 1/16 (22.5°) turn; at 45 rpm, 1/10 turn; at 78 rpm, ½ turn.
NOISE OR RUMBLE: Stereo (below NAB reference of 1 kHz recorded at 3.54 cm/sec. rms velocity); -45 dB at 33⅓ rpm.
WOW AND FLUTTER: Less than 0.1%. NAB unweighted at 33⅓ rpm.
MOTOR START: By pushbutton switch on front panel.

SPEED CHANGE: To 33⅓, 45, or 78 rpm by single Teflon sleeved index lever control.
SPEED ACCURACY: Better than ±0.3% at 33⅓ rpm.
IDLER WHEEL: Shear action, concentric ground Neoprene, self-aligning.
POWER: 115 volts, ±10%, 60 Hz, 35 watts maximum (50 Hz model for 117V or 220 V available).
WEIGHT: 21 lbs. Net. Packed: domestic, 26 lbs; export, 50 lbs. Cubage: 1.3 cubic feet.

ORDERING INFORMATION

CB-1201 Turntable, chassis only, 60 Hz, 117V 994-7866-001
 CB-1201 Turntable, chassis only, 50 Hz, 117V 994-7866-002

TRANSISTORIZED IC TURNTABLE PREAMPLIFIER

Single-channel transistorized turntable preamplifier features low distortion and excellent frequency response. Designed for use in broadcasting, recording and for general sound requirements, Harris' IC preamp's input impedance of 47,000 ohms makes it compatible with virtually all magnetic cartridges (including stereo). It is self-equalized to the standard RIAA/NAB frequency response curve. Special mounting holes have been provided on the top of the preamplifier housing to "piggyback" a second unit for stereo operation.

The preamplifier is completely self-contained in an aluminum housing, and includes an integrated circuit, current booster and associated components, plus the output transformer and power supply.

SPECIFICATIONS

INPUT IMPEDANCE: 47,000 ohms.
MAXIMUM INPUT: 150 mV @ 1 kHz (clip point), 60 mV @ 1 kHz (+15 dBm output).
OUTPUT: -2 dBm with 9 mV input @ 1 kHz (typical cartridge level).
RESPONSE: Within ±1 dB of RIAA/NAB standard curve.
DISTORTION: Less than 0.5% at +15 dBm output, 30-15,000 Hz. Typically less than 0.1%.
NOISE: At least 85 dB below +15 dBm output, 20 Hz to 20 kHz. Typically below 93 dB.
LOAD IMPEDANCE: 600 ohms or 150 ohms, floating for grounded or ungrounded loads.
OPERATING AMBIENT TEMPERATURE RANGE: 0° to +60° C.
POWER: 117/234 volts, 50/60 Hz, 1 watt.
SIZE: 7-7/16" long, 3-½" deep, 2-1/16" high. Net weight, 1 lb.

ORDERING INFORMATION

Monaural IC Turntable Preamplifier 994-6690-003
 Stereo IC Turntable Preamplifier 994-6977-002



MONAURAL



STEREO

12-INCH SYSTEM COMPONENTS

The following components are recommended to make up your 12-inch turntable system.

Monophonic System

CB-1201 turntable 994-7866-001
 Audio Technica AT-1005 723-0405-000
 Stanton 600A 723-0358-000
 IC turntable preamplifier 994-6690-003

Stereo System

CB-1201 turntable 994-7866-001
 Audio Technica AT-1005 723-0405-000
 Stanton 600A 723-0358-000
 IC turntable preamplifier 994-6977-002



HARRIS

RACK CABINETS AND ACCESSORIES

- 994-8592-001 * RAK-91 Basic Rack, textured black finish, 78" high, 25½" deep, 22½" wide with louvered top, louvered rear door, two (2) sets of panel mounting angles (one set fixed and one set movable) with EIA standard hole spacing and panel mounting hardware. 70" panel mounting space. Less trim and sides.
- 994-8595-001 * RAK-91 side panel kit, two panels and mounting hardware in kit. (Harris white finish).
- 994-8430-002 * RAK-90 Basic Rack, textured black finish, 78" high, 22" deep, 22½" wide with louvered top, louvered rear door, two (2) sets of panel mounting angles (one set fixed and one set movable) with EIA standard hole spacing and panel mounting hardware. 70" panel mounting space. Less trim and sides.
- 994-8433-001 * RAK-90 side panel kit, two panels and mounting hardware in kit. (Harris white finish).
- 994-8444-001 * Front Trim Kit for single cabinet**
- 994-8444-002 * Front Trim Kit for two (2) cabinets**
- 994-8444-003 * Front Trim Kit for three (3) cabinets**
- 994-8444-004 * Front Trim Kit for four (4) cabinets**
- 994-8471-001 * Rear door louver closure kit, contains two (2) panels and mounting materials.
**Front trim finished in brushed aluminum with Harris blue insert.
- 994-8477-001 * RAK-80B Basic Rack, textured black finish 72" high, 25½" deep and 22½" wide with louvered top, louvered rear door, rear top cowling, two (2) sets of panel mounting angles with new EIA standard panel mounting hole spacing and panel mounting hardware. Less front trim and sides, 64¾" panel mounting space.
- 994-8478-001 * RAK-80B Side Panel Kit for above, two panels included in kit. (Harris white finish).
- 448-0702-000 Lock w/key
- 994-8444-001 Front Trim Kit for single cabinet**
- 994-8444-002 Front Trim Kit for two (2) cabinets**
- 994-8444-003 Front Trim Kit for three (3) cabinets**
- 994-8444-004 Front Trim Kit for four (4) cabinets**
- 994-8471-001 Louver Closure Panel for rear door.
**Front trim finished in brushed aluminum with Harris blue insert.
- 994-5527-003 * RAK-7 Rak Cabinet, 78" high, 23½" wide and 19½" deep. 71¾" panel mounting space. Complete with sides, non-louvered top, louvered rear door and panel mounting hardware. Standard EIA hole spacing. White textured finish.

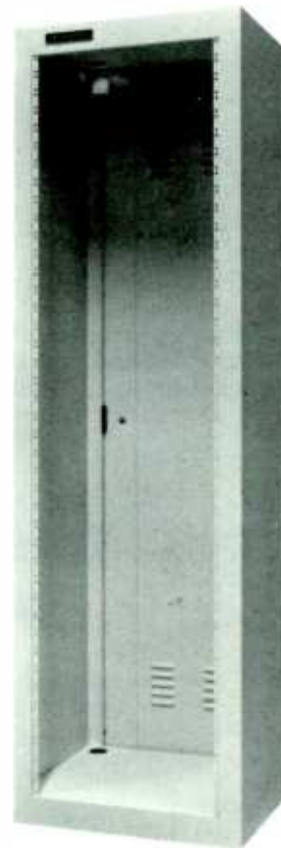

RACK ACCESSORIES

- 265-0061-000 Plugmold (10 out.) w/Ent. Fit.
- 432-0214-000 Blower/Panel Assembly (150 CFM)
- 432-0225-000 Blower/Panel/Filter Assembly, 150 CFM, panel size 5¼" x 19", 115 VAC, 50/60 Hz
NOTE: Blower/Panel Assemblies are 19" wide, 3½" high and 12½" deep. Finished bright chrome.
- 994-6582-001 * Panel mounting hardware kit
- 992-2539-001 * Panel Mounting Hardware
- 994-6891-001 Pre-wired jack panel and terminal board.

BLANK PANELS

- 831-5483-003 Blank panel, 19" x 1¾" W/HF-88 126 Black Pebbletex Finish
- 831-5483-011 Blank panel, 19" x 3½" W/HF-88 126 Black Pebbletex Finish
- 831-5483-019 Blank panel, 19" x 5¼" W/HF-88 126 Black Pebbletex Finish
- 831-5483-027 Blank panel, 19" x 7" W/HF-88 126 Black Pebbletex Finish
- 831-5483-035 Blank panel, 19" x 8¾" W/HF-88 126 Black Pebbletex Finish
- 831-5483-043 Blank panel, 19" x 10½" W/HF-88 126 Black Pebbletex Finish

OTHER

- 994-7001-001 * Power Control Panel provides on-off switching of 110 VAC and/or VAC, 19" x 3½" x 3½"

INDEX

PDM Pulse Duration Modulation	1
PSM Progressive Series Modulator	2
MEDIUM WAVE BROADCAST TRANSMITTERS & ACCESSORIES	
100,000 watt, VP-100A	3
50,000 watt, MW-50B	7
10,000 watt, MW-10B	11
5000 watt solid state, SX-5	15
2500 watt solid state, SX-2.5	19
1000 watt solid state, SX-1	23
Antenna phasing equipment	27
Medium wave modulation monitor, AM-90	33
Medium wave frequency monitor, AF-80	35
30 amp RF contactor	36
SERVICE AND TRAINING	38
SHORT WAVE BROADCAST TRANSMITTERS	
100,000 watt, SW-100A	39
Water purification unit	43
50,000 watt, SW-50A	45
FM BROADCAST TRANSMITTERS	
50 kilowatt, FMD-50K	49
40 kilowatt, FM-40K	53
25 kilowatt, FM-25K	57
20 kilowatt, FM-20K	61
10 kilowatt, FM-10K	65
5 kilowatt, FM-5K	69
2.5 kilowatt, FM-2.5K	73
1 kilowatt, FM-1K	77
300 watt, FM-300KD/FM-300K	81
100 watt, FM-100K	85
FM exciter, MS-15	89
CIRCULARLY POLARIZED FM ANTENNAS	
Super power, FMH	93
Low power, FML	95
Dual Cycloid, FMS	97
Dual Cycloid II/III	99
Directional Dual Polarized	101
VHF COLOR TV TRANSMITTERS & ACCESSORIES	
50 kilowatt/100 kilowatt dual high band, TV-50H/TVD-100H	105
50 kilowatt dual high band, TVD-50H	111
36 kilowatt dual high band, TVD-36H	117
35 kilowatt high band, TV-35H	123
25 kilowatt high band, TV-25H	127
18 kilowatt high band, TV-18H	131
10 kilowatt CCIR Band III, TV-10H	135
60 kilowatt dual low band, TVD-60L	139
45 kilowatt dual low band, TVD-40L	145
30 kilowatt low band, TV-30L	151
22.5 kilowatt low band, TV-20L	155
Visual exciter/modulator, MCP-1V	159
UHF COLOR TV TRANSMITTERS & ACCESSORIES	
110 kilowatt, TVE-110	161
55 kilowatt, TVE-55	165
30 kilowatt, TVE-30	171
Visual exciter/modulator, MCP-2U	177
TV ANTENNAS	
Circularly polarized, CPV	179
Cavity backed radiator circularly polarized, CBR	185
UHF, Quadrapower	189
VHF, Batwing	195
Traveling wave helical	201

LIVE COLOR TV CAMERAS	
Computer setup camera, TC-85	205
Triax cable system	211
Studio camera, TC-50B	213
Portable ENG/EFP camera, TC-90	219
DIGITAL VIDEO EQUIPMENT	
EPIC computer-aided editing equipment	221
IRIS digital still store	225
Digital time base corrector, 516WB	231
Digital time base corrector, 590	235
Time base corrector, 506	239
PAL/SECAM digital video time base corrector, 517	241
PAL video time base corrector, 507	245
Digital frame synchronizer, 630	247
BROADCAST MICROWAVE EQUIPMENT	
ENG microwave transmitter, Global IX	252
Video transmission equipment, FV-40	254
Miniature portable microwave link, FV2-2.5MP	259
Miniature portable microwave link, FV-MP	265
Heterodyne microwave, FV-F	271
Miniature portable transmitter for ENG, FV2/2.5MF	277
ENG microwave receiver, FV2CR	279
Microwave radio receiver for ENG, FV2.5CR	282
ENG microwave radio receiver, FV7CR	285
RF power amplifier, 60732-M2	288
Low noise preamplifier, 60576-M2	290
Power amplifier, 60615	292
Portable test unit, 60637	293
SATELLITE EARTH STATIONS	
9.1 meter antenna	295
6.1 meter antenna	299
Video receiver, 6521	303
Antenna positioner, 7022	305
Satellite controller, 9165	313
AUTOMATION	
Facilities control for Radio or TV, Harris 9100	307
Satellite controller, 9165	313
Floppy disk unit for Harris 9100	314
Harris 9000 program control	315
Business automation system, Autotron Star	321
Word processing, Autotron Star	327
Office automation, Infowriter	329
AUDIO	
Digital modular audio console, MICRO MAC	331
Production/on-air audio console, M90	337
On-air audio console, M90	345
10 channel stereo audio console, Executive	347
8 channel stereo audio console, Stereo 80	351
Solid state 5 channel audio console, Stereo 5	355
Solid state 8 channel audio console, Gateway 80	359
Solid state 5 channel audio console, Mono 5	363
Audio processor, MSP-90	367
Tri band AGC audio processor, MSP-90	371
FM audio composite processing unit, MSP-95	373
Remote SCA generator, MSG-95	377
Precision professional turntable, CB-1201	379
RACK CABINETS & ACCESSORIES	
	381
TERMS & CONDITIONS	
	384

GENERAL TERMS & CONDITIONS OF SALE FOR BROADCAST EQUIPMENT AND SERVICES

DEFINITIONS:

The term "You" as referred to herein means the Purchaser of Harris Corporation, Broadcast Products Division Equipment and Services... The term "Harris" as referred to herein means Harris Corporation, Broadcast Products Division with offices in Quincy, Illinois.

ACCEPTANCE:

Your order shall be deemed to be accepted by Harris when Harris mails to you its standard acknowledgement form... Harris will return to you any advance payment or cancellation... Harris will not be held responsible for any loss or damage to equipment...

PRICE:

Except as provided for herein, Harris agrees to make no price adjustments after the order is shipped... If this order provided for deferred payment terms, Harris may increase the rate of finance charge, provided for herein...

DELAYS IN DELIVERY AT THE REQUEST OF YOUR ORGANIZATION MAY GIVE RISE TO A PRICE ADJUSTMENT BY HARRIS PRIOR TO SHIPMENT. For contingent orders see "Contingent Orders" below.

CONTINGENT ORDERS:

If this order is designated as being a contingent order, You represent that You have pending or will file with the F.C.C. an application for a construction permit... If this order is acknowledged as being a contingent order and is accompanied by an advance payment, and if You, by written instruction, make the order firm within a six (6) month period after the date of shipment...

TAXES:

Unless this order specifically indicates that all applicable taxes are included in the price, Harris shall invoice and You shall be required to pay the applicable taxes... Seller and purchaser with specific reference to State and Local Taxes imposed by Law in the various States, Commonwealths and Protectorates of the United States.

If You claim to be exempt from tax, then You must submit to Harris a tax exempt number or certificate. If Harris for any reason is required to pay applicable taxes, You hereby agree to reimburse Harris accordingly.

INSURANCE:

In the event that this order involves deferred payments and when required by Harris to protect its financial interest, You agree to insure the equipment in transit and against fire and theft... You agree to maintain such insurance until full payment shall have been made in full.

DELIVERY:

If You delay shipment, payments are to be made as though shipment had been made and the equipment shall be stored by Harris at Your expense... Harris shall not be held responsible for any loss or damage to equipment...

If shipment of any item is delayed by Harris for more than six (6) months beyond the shipping date specified herein, or as amended, either party may terminate this contract as to any such items by written notice to the other...

SHIPPING DATES INDICATED HEREIN AND AS MAY BE SUBSEQUENTLY CANCLED TO YOU ARE APPROXIMATE AND SUBJECT TO CHANGE WITHOUT NOTICE...

Harris shall have the one lot, and payment for each lot shall be due accordingly.

Shipments will not normally be made until all required Security Agreements have been executed and approved by Harris.

FREIGHT CHARGES AND TRANSPORTATION INSURANCE:

Unless otherwise stated on the face hereof all prices and terms are F.O.B. place of shipment and are exclusive of freight charges. Shipping charges to Your destination will be added to the Harris invoice.

As a service to You on prepaid shipments from our facilities, Harris will insure the equipment on the equipment, which it is in transit within the continental United States... Harris will not be held responsible for any loss or damage to equipment...

Method of shipment will normally be determined by Your order carrier will be selected by Harris as a convenience to You.

INSTALLATION AND MAINTENANCE:

Except as stated in the order, You are responsible for the prompt installation and proper maintenance of the equipment in accordance with Harris' Instruction Books and good Engineering practice... Harris will not be held responsible for any loss or damage to equipment...

TITLE AND REMEDIES:

Until full payment of all obligations hereunder (whether represented by notes, open account, judgement, or otherwise), Harris reserves title to all of the Equipment delivered by reason of nonpayment and Harris may in accordance with existing Laws, repossess the Equipment, and exercise such other or differing remedies as are provided by Law.

When requested by Harris, we require that You duly execute and deliver to Harris on Harris' standard forms, a security agreement, financial statement, or other appropriate instrument which Harris may require to cover the financed conditions of this transaction.

You hereby authorize Harris, or its assignee, where permitted by Law, to sign and file financing statements in order to perfect the security interest of the financing party.

If in the judgement of Harris, either before or after manufacture or shipment of equipment, the financial responsibility of Your organization is such as to indicate inability to pay its obligations as they mature, Harris, upon giving of the herein notice to you may require payment in full or Harris, upon giving of the herein notice to you may require payment in full or Harris, upon giving of the herein notice to you may require payment in full (10) day period after the date of the notice. This provision may apply irrespective of the terms of payment stated in the order or the acknowledgement. Harris shall be under no obligation to deliver equipment until payments are received.

TOWER, ANTENNA AND RELATED SERVICES:

In the event that this contract covers tower and antenna erection work, including tower foundations, etc., Harris shall let a subcontractor to perform the work... Harris shall not be held responsible for any loss or damage to equipment...

You agree that prior to shipment of tower or antenna as may be covered by this contract and/or for which services at the site are also included in the contract (a) all permits required shall be approved and issued; (b) the site will be level and clear and staked off prior to arrival... Harris shall not be held responsible for any loss or damage to equipment...

In the event that this order covers an antenna to be installed on an existing tower, Harris shall be responsible for determining to Your complete satisfaction, the additional weight and wind loading associated with such an antenna and related hardware and the installation thereof.

SERVICE PARTS LIMITED WARRANTY:

In the event that this order includes replacement service parts, the following warranty period shall apply... Harris shall not be held responsible for any loss or damage to equipment...

MANUFACTURERS' LIMITED NEW EQUIPMENT WARRANTY:

Harris warrants Equipment of its manufacture against defects in material or workmanship at the time of delivery... Harris shall not be held responsible for any loss or damage to equipment...

Harris' sole responsibility for any breach of the above warranty provision shall be limited to the repair or replacement of the Equipment or parts not conforming to the specifications of the Equipment or parts F.O.B. Harris... Harris shall not be held responsible for any loss or damage to equipment...

HARRIS WORK PERFORMED BY HARRIS COVERS PARTS ONLY:

Labor and any travel by Harris will be invoiced to You. Defects or failures caused by Your abuse or misuse of the equipment or maintenance procedures are not covered by this warranty provision.

on behalf of Your organization and shall not be liable for any expenses whether for labor or materials... Harris shall not be held responsible for any loss or damage to equipment...

NO EQUIPMENT IS TO BE RETURNED TO HARRIS WITHOUT FIRST RECEIVING HARRIS INSTRUCTIONS REGARDING RETURN PROCEDURE

EXCEPT AS SET FORTH HEREIN, AND RANTIES, OR ANY AFFIRMATIONS OF FACT OR PROMISES BY HARRIS, WITH REFERENCE TO THE EQUIPMENT, OR TO MERCHANTABILITY, FITNESS FOR A PARTICULAR APPLICATION, SIGNAL COVERAGE, INFRINGEMENT, OR OTHERWISE WHICH EXTEND BEYOND THE DESCRIPTION OF THE EQUIPMENT ON THE FACE HEREOF.

FACILITY CONTROL EQUIPMENT:

If this order includes Facility Control Equipment which is intended to be used by Your organization to control and/or monitor line and/or burglar alarm equipment, then it is to be understood and You agree that Harris is not an insurer and that the amount payable to Harris under this order is based upon the value of the item purchased... Harris shall not be held responsible for any loss or damage to equipment...

ADDITIONAL PROVISIONS:

This contract shall be governed by the Laws of the State of Illinois.

You agree to indemnify Harris against all claims arising out of or resulting from the erection, operation or use of the Equipment, whether on account of negligence or otherwise, except those asserted by Harris employees.

No person is authorized to give any other warranties or to assume in writing on Harris and accepted by Harris at its home office.

YOU ARE EXPRESSLY NOTIFIED THAT HARRIS LIABILITY HEREUNDER SHALL NOT INCLUDE LOSSES OF ANTICIPATED PROFITS OR SPECIAL INCIDENTAL OR CONSEQUENTIAL DAMAGES.

If the Equipment specified herein is described as used, it is sold as is and with no warranty. If the contract covers Equipment not so described, as of the date hereof, it is sold subject to Harris acquisition of possession and title.

All sales are final and not subject to return of equipment unless so stated herein. Should circumstances necessitate return other than for a valid warranty reason, You hereby acknowledge Harris' policy to charge a minimum 15% handling and restocking fee.

Model, nomenclature and the mechanical and electrical design of Equipment described herein are subject to change without notice.

Each provision of this contract is severable, and in the event that any one or more provisions hereof may be deemed invalid by Law, or may be waived by Harris, then the remainder of this agreement shall nevertheless remain in full force and effect.

Except as may be set forth herein, cancellation of this order in whole or in part by You can only be made by the return of the Equipment to Harris and shall be subject to Harris' reasonable cancellation charges.

The mechanical and electrical design of the equipment described herein is subject to change without notice as deemed necessary by the Broadcast Division of Harris Corporation or its suppliers, in the interest of advancing industry requirements or the state of the art.



HARRIS

©HARRIS CORPORATION, 1982



HARRIS

HARRIS CORPORATION BROADCAST DIVISION
P. O. BOX 4290, QUINCY, ILLINOIS 62305-4290 U.S.A.

E
L
Pe
Shav
* * * * *
* SOUND PRINTED MATTER *
* BULK RATE *
* US POSTAGE PAID *
* PERMIT NO. 243 *
* SHAWNEE MSN KS *

KDGH
Natchitoches Brdstg. Co. Chf. Eng.
P. O. Box607
Natchitoches, LA 71457